

# Silicon Carbide (SiC) MOSFET – EliteSiC, 13 mohm, 1200 V, M3S, TO-247-4L

## NTH4L013N120M3S

### Features

- Typ.  $R_{DS(on)}$  = 13 m $\Omega$  @  $V_{GS}$  = 18 V
- Ultra Low Gate Charge ( $Q_{G(tot)}$  = 254 nC)
- High Speed Switching with Low Capacitance ( $C_{oss}$  = 262 pF)
- 100% Avalanche Tested
- This Device is Halide Free and RoHS Compliant with exemption 7a, Pb-Free 2LI (on second level interconnection)

### Typical Applications

- Solar Inverters
- Electric Vehicle Charging Stations
- UPS (Uninterruptible Power Supplies)
- Energy Storage Systems
- SMPS (Switch Mode Power Supplies)

### MAXIMUM RATINGS ( $T_J$ = 25°C unless otherwise noted)

Parameter	Symbol	Value	Unit
Drain-to-Source Voltage	$V_{DSS}$	1200	V
Gate-to-Source Voltage	$V_{GS}$	-10/+22	V
Continuous Drain Current – Steady State (Notes 1, 3) $T_C$ = 25°C $T_C$ = 100°C	$I_D$	151 107	A
Power Dissipation – Steady State (Note 1) $T_C$ = 25°C $T_C$ = 100°C	$P_D$	682 340	W
Pulsed Drain Current (Note 2), $T_C$ = 25°C	$I_{DM}$	505	A
Operating Junction and Storage Temperature Range	$T_J, T_{stg}$	-55 to +175	°C
Source Current (Body Diode), $T_C$ = 25°C, $V_{GS}$ = -3 V	$I_S$	151	A
Single Pulse Drain-to-Source Avalanche Energy (Note 4)	$E_{AS}$	800	mJ
Maximum Lead Temperature for Soldering (1/25" from case for 10 s)	$T_L$	270	°C

Stresses exceeding those listed in the Maximum Ratings table may damage the device. If any of these limits are exceeded, device functionality should not be assumed, damage may occur and reliability may be affected.

1. The entire application environment impacts the thermal resistance values shown, they are not constants and are only valid for the particular conditions noted.
2. Repetitive rating, limited by max junction temperature.
3. The maximum current rating is based on typical  $R_{DS(on)}$  performance.
4.  $E_{AS}$  of 800 mJ is based on starting  $T_J$  = 25°C;  $L$  = 1 mH,  $I_{AS}$  = 40 A,  $V_{DD}$  = 100 V,  $V_{GS}$  = 18 V.

$V_{(BR)DSS}$	$R_{DS(ON)}$ TYP	$I_D$ MAX
1200 V	13 m $\Omega$ @ 18 V	151 A

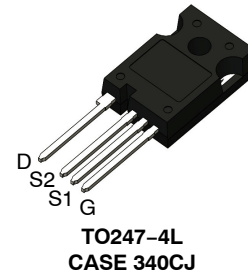
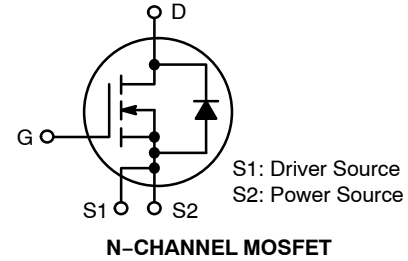

### MARKING DIAGRAM

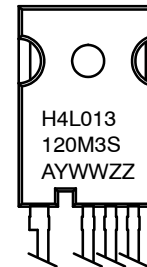

H4L013120M3S = Specific Device Code  
A = Assembly Location  
Y = Year  
WW = Work Week  
ZZ = Lot Traceability

### ORDERING INFORMATION

Device	Package	Shipping
NTH4L013N120M3S	TO247-4L	30 Units / Tube

# NTH4L013N120M3S

## THERMAL CHARACTERISTICS

Parameter	Symbol	Typ	Max	Unit
Junction-to-Case – Steady State (Note 1)	$R_{\theta JC}$	0.17	0.22	°C/W
Junction-to-Ambient – Steady State (Note 1)	$R_{\theta JA}$	–	40	

## RECOMMENDED OPERATING CONDITIONS

Parameter	Symbol	Value	Unit
Operation Values of Gate-to-Source Voltage	$V_{GSop}$	-5...-3 +18	V

Functional operation above the stresses listed in the Recommended Operating Ranges is not implied. Extended exposure to stresses beyond the Recommended Operating Ranges limits may affect device reliability.

## ELECTRICAL CHARACTERISTICS ( $T_J = 25^\circ\text{C}$ unless otherwise specified)

Parameter	Symbol	Test Condition	Min	Typ	Max	Unit
-----------	--------	----------------	-----	-----	-----	------

### OFF-STATE CHARACTERISTICS

Drain-to-Source Breakdown Voltage	$V_{(BR)DSS}$	$V_{GS} = 0\text{ V}, I_D = 1\text{ mA}$	1200	–	–	V
Drain-to-Source Breakdown Voltage Temperature Coefficient	$V_{(BR)DSS}/T_J$	$I_D = 1\text{ mA}$ , referenced to $25^\circ\text{C}$ (Note 6)	–	0.3	–	V/°C
Zero Gate Voltage Drain Current	$I_{DSS}$	$V_{GS} = 0\text{ V}, V_{DS} = 1200\text{ V}$ $T_J = 25^\circ\text{C}$	–	–	100	$\mu\text{A}$
Gate-to-Source Leakage Current	$I_{GSS}$	$V_{GS} = +22/-10\text{ V}, V_{DS} = 0\text{ V}$	–	–	$\pm 1$	$\mu\text{A}$

### ON-STATE CHARACTERISTICS (Note 2)

Gate Threshold Voltage	$V_{GS(TH)}$	$V_{GS} = V_{DS}, I_D = 37\text{ mA}$	2.04	2.8	4.4	V
Drain-to-Source On Resistance	$R_{DS(on)}$	$V_{GS} = 18\text{ V}, I_D = 75\text{ A}, T_J = 25^\circ\text{C}$	–	13	20	m $\Omega$
		$V_{GS} = 18\text{ V}, I_D = 75\text{ A}, T_J = 175^\circ\text{C}$ (Note 6)	–	29	–	
Forward Transconductance	$g_{FS}$	$V_{DS} = 10\text{ V}, I_D = 75\text{ A}$ (Note 6)	–	57	–	S

### CHARGES, CAPACITANCES & GATE RESISTANCE

Input Capacitance	$C_{ISS}$	$V_{GS} = 0\text{ V}, f = 1\text{ MHz}, V_{DS} = 800\text{ V}$ (Note 6)	–	5813	–	pF
Output Capacitance	$C_{OSS}$		–	262	–	
Reverse Transfer Capacitance	$C_{RSS}$		–	21	–	
Total Gate Charge	$Q_{G(TOT)}$	$V_{GS} = -3/18\text{ V}, V_{DS} = 800\text{ V}, I_D = 75\text{ A}$ (Note 6)	–	254	–	nC
Threshold Gate Charge	$Q_{G(TH)}$		–	37	–	
Gate-to-Source Charge	$Q_{GS}$		–	46	–	
Gate-to-Drain Charge	$Q_{GD}$		–	61	–	
Gate-Resistance	$R_G$	$f = 1\text{ MHz}$	–	1.4	–	$\Omega$

### SWITCHING CHARACTERISTICS

Turn-On Delay Time	$t_{d(ON)}$	$V_{GS} = -3/18\text{ V}, V_{DS} = 800\text{ V}, I_D = 75\text{ A}, R_G = 4.7\text{ }\Omega$ Inductive load (Notes 5, 6)	–	22	–	ns
Rise Time	$t_r$		–	23	–	
Turn-Off Delay Time	$t_{d(OFF)}$		–	56	–	
Fall Time	$t_f$		–	10	–	
Turn-On Switching Loss	$E_{ON}$		–	563	–	$\mu\text{J}$
Turn-Off Switching Loss	$E_{OFF}$		–	390	–	
Total Switching Loss	$E_{tot}$		–	953	–	

# NTH4L013N120M3S

## ELECTRICAL CHARACTERISTICS ( $T_J = 25^\circ\text{C}$ unless otherwise specified) (continued)

Parameter	Symbol	Test Condition	Min	Typ	Max	Unit
<b>SOURCE-DRAIN DIODE CHARACTERISTICS</b>						
Continuous Source-Drain Diode Forward Current	$I_{SD}$	$V_{GS} = -3\text{ V}, T_C = 25^\circ\text{C}$ (Note 6)	-	-	151	A
Pulsed Source-Drain Diode Forward Current (Note 2)	$I_{SDM}$		-	-	505	
Forward Diode Voltage	$V_{SD}$	$V_{GS} = -3\text{ V}, I_{SD} = 75\text{ A}, T_J = 25^\circ\text{C}$	-	4.7	-	V
Reverse Recovery Time	$t_{RR}$	$V_{GS} = -3/18\text{ V}, I_{SD} = 75\text{ A},$ $di_S/dt = 1000\text{ A}/\mu\text{s}, V_{DS} = 800\text{ V}$ (Note 6)	-	29	-	ns
Reverse Recovery Charge	$Q_{RR}$		-	252	-	nC
Reverse Recovery Energy	$E_{REC}$		-	26	-	$\mu\text{J}$
Peak Reverse Recovery Current	$I_{RRM}$		-	18	-	A
Charge Time	$T_A$		-	17	-	ns
Discharge Time	$T_B$		-	12	-	ns

Product parametric performance is indicated in the Electrical Characteristics for the listed test conditions, unless otherwise noted. Product performance may not be indicated by the Electrical Characteristics if operated under different conditions.

5.  $E_{ON}/E_{OFF}$  result is with body diode.

6. Defined by design, not subject to production test.

TYPICAL CHARACTERISTICS

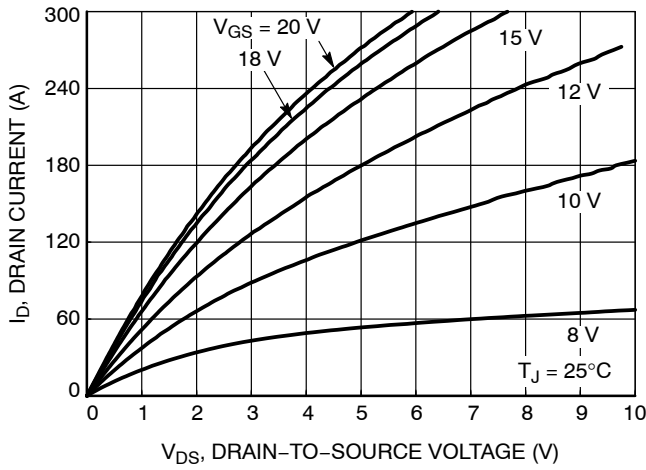

Figure 1. On-Region Characteristics

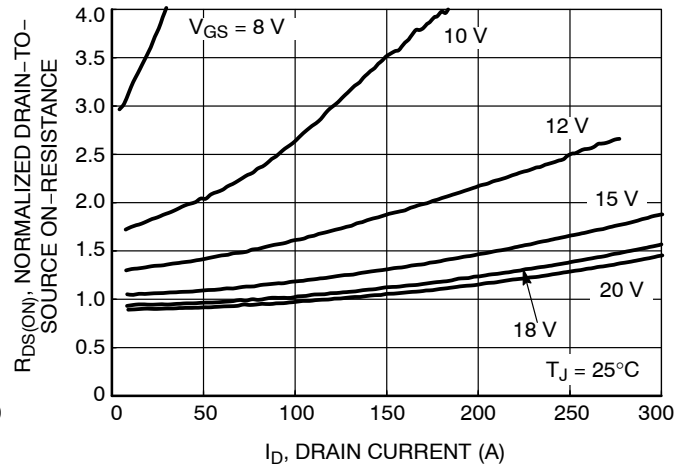

Figure 2. Normalized On-Resistance vs. Drain Current and Gate Voltage

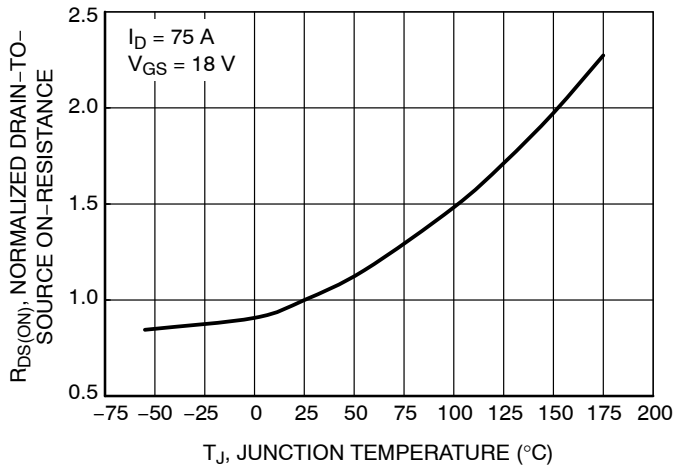

Figure 3. On-Resistance Variation with Temperature

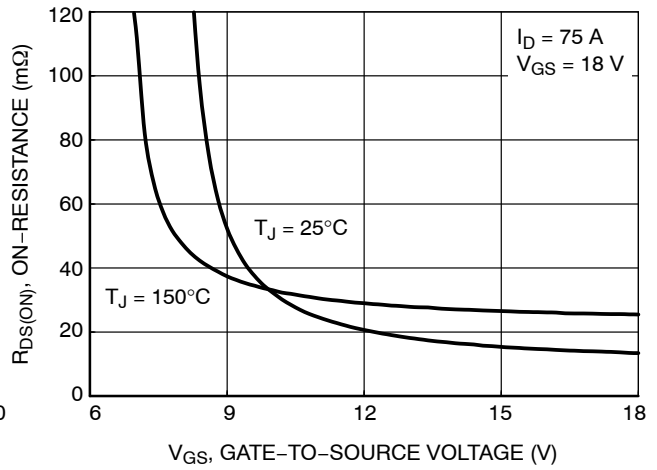

Figure 4. On-Resistance vs. Gate-to-Source Voltage

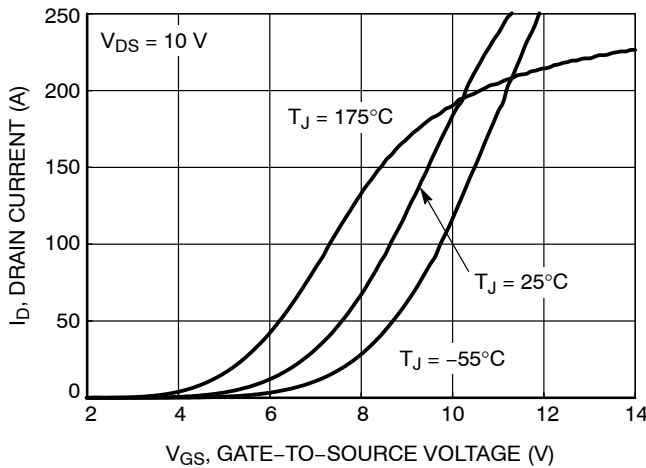

Figure 5. Transfer Characteristics

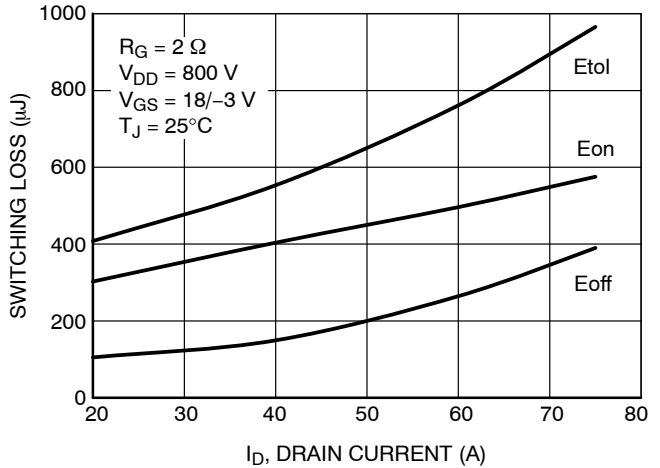
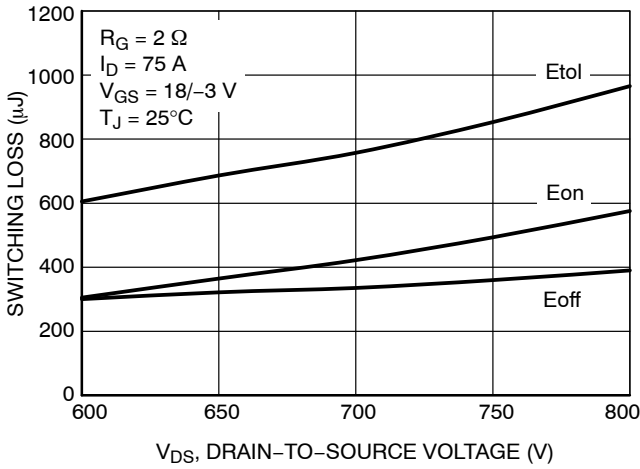

Figure 6. Switching Loss vs. Drain Current

# NTH4L013N120M3S

## TYPICAL CHARACTERISTICS



**Figure 7. Switching Loss vs. Drain-to-Source Voltage**

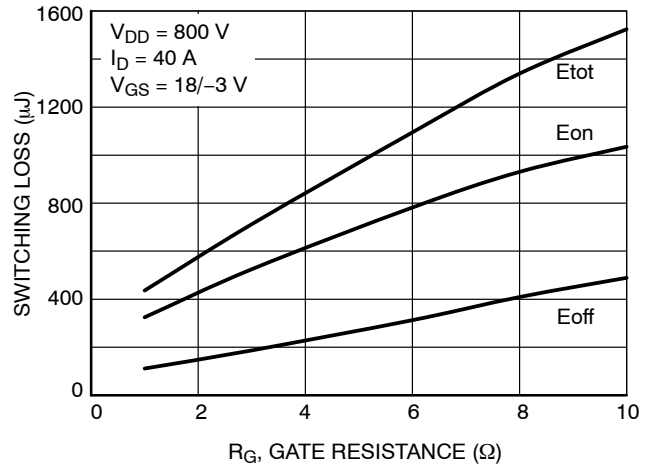

**Figure 8. Switching Loss vs. Gate Resistance**

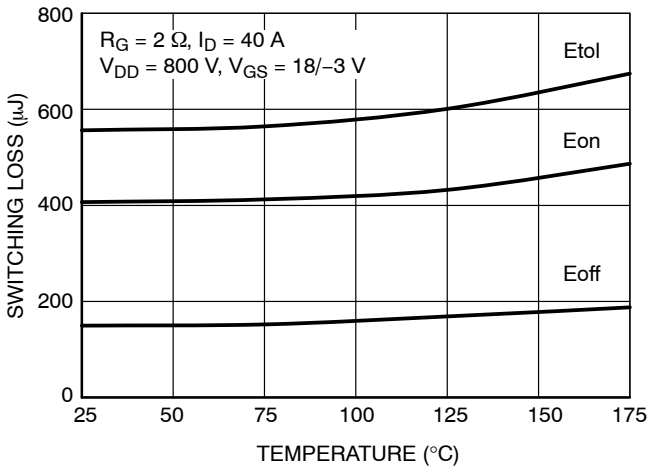

**Figure 9. Switching Loss vs. Temperature**

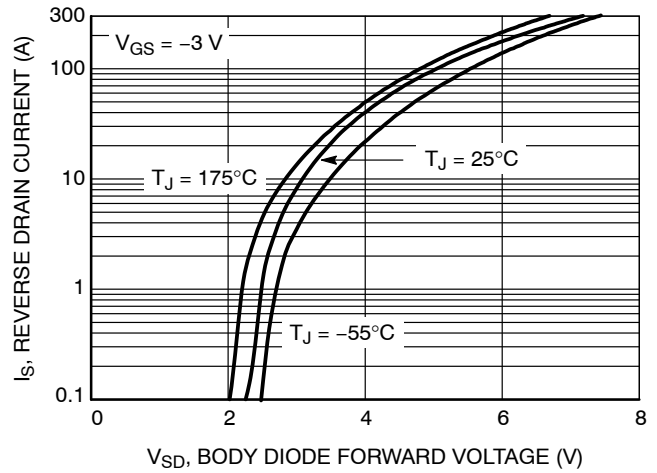

**Figure 10. Reverse Drain Current vs. Body Diode Forward Voltage**

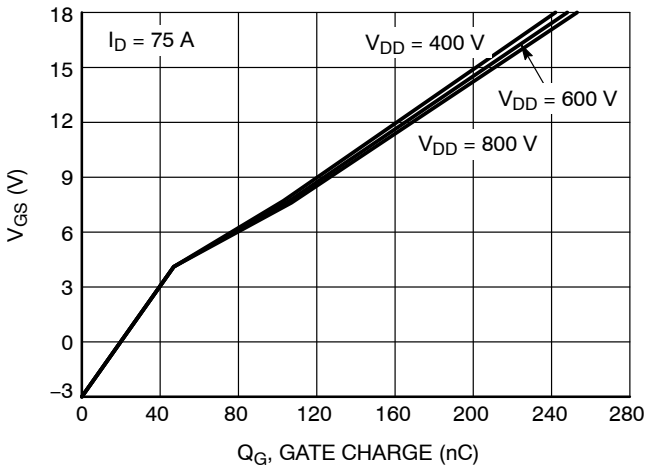

**Figure 11. Gate-to-Source Voltage vs. Total Charge**

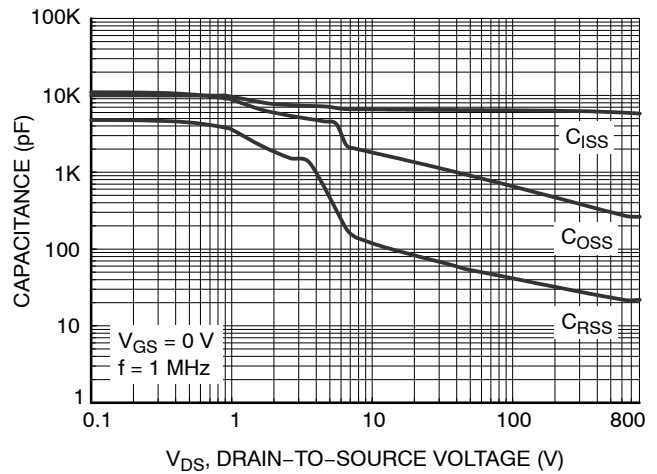

**Figure 12. Capacitance vs. Drain-to-Source Voltage**

# NTH4L013N120M3S

## TYPICAL CHARACTERISTICS

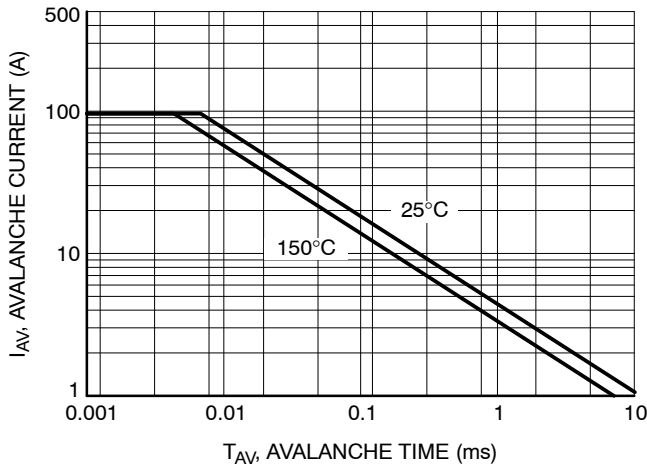

**Figure 13. Unclamped Inductive Switching Capability**

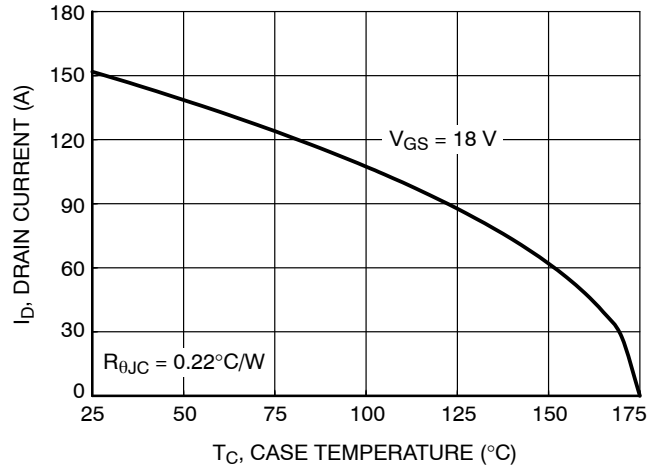

**Figure 14. Maximum Continuous Drain Current vs. Case Temperature**

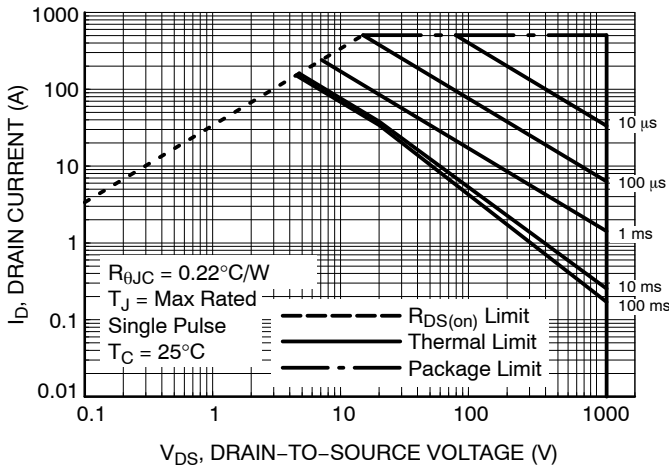

**Figure 15. Safe Operating Area**

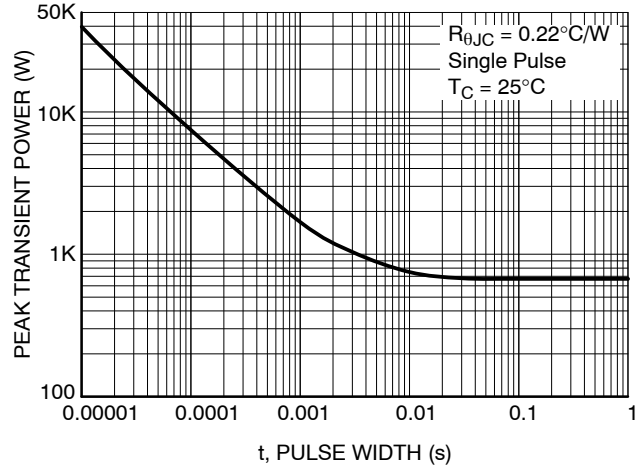

**Figure 16. Single Pulse Maximum Power Dissipation**

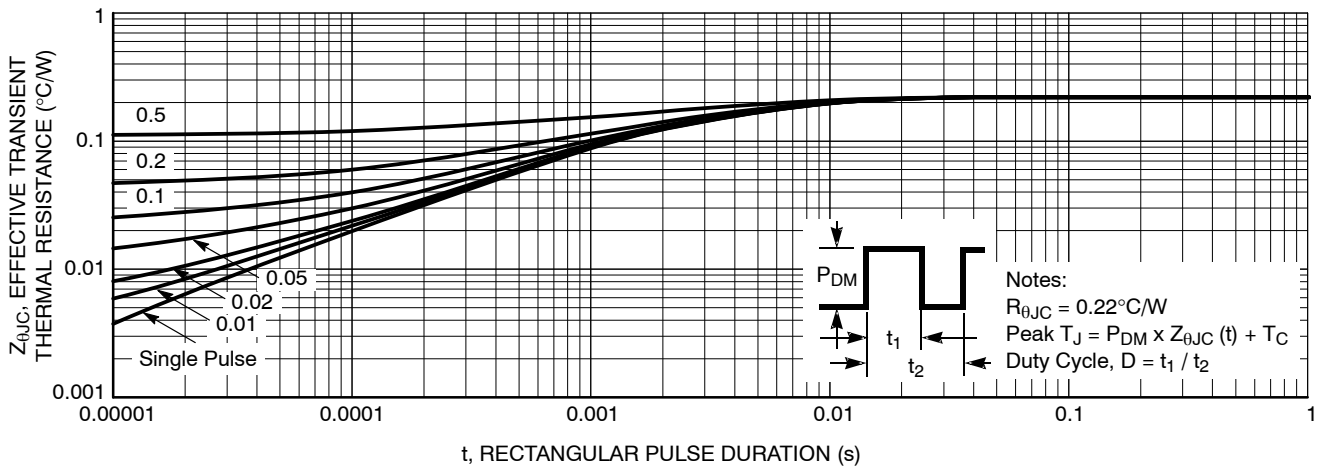

**Figure 17. Junction-to-Case Transient Thermal Response**

**TO-247-4LD**  
**CASE 340CJ**  
**ISSUE A**

DATE 16 SEP 2019

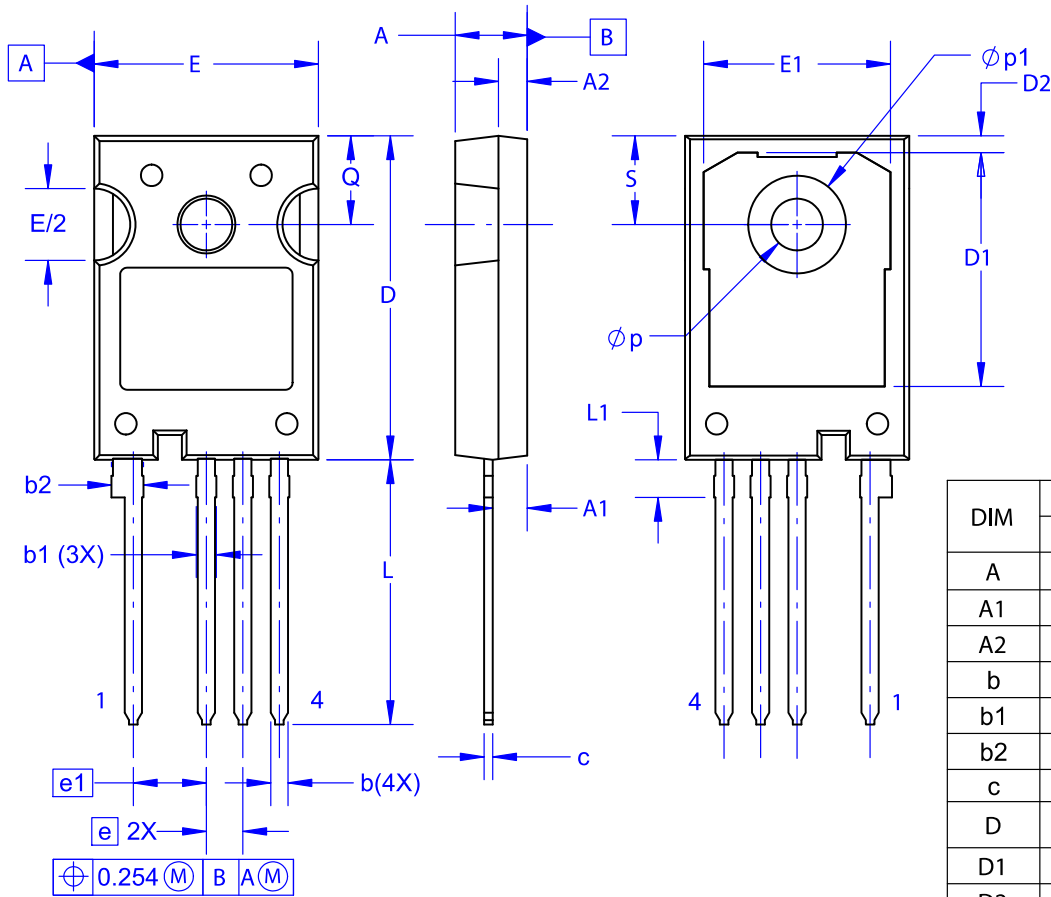

DIM	MILLIMETERS		
	MIN	NOM	MAX
A	4.80	5.00	5.20
A1	2.10	2.40	2.70
A2	1.80	2.00	2.20
b	1.07	1.20	1.33
b1	1.20	1.40	1.60
b2	2.02	2.22	2.42
c	0.50	0.60	0.70
D	22.34	22.54	22.74
D1	16.00	16.25	16.50
D2	0.97	1.17	1.37
e	2.54 BSC		
e1	5.08 BSC		
E	15.40	15.60	15.80
E1	12.80	13.00	13.20
E/2	4.80	5.00	5.20
L	18.22	18.42	18.62
L1	2.42	2.62	2.82
p	3.40	3.60	3.80
p1	6.60	6.80	7.00
Q	5.97	6.17	6.37
S	5.97	6.17	6.37

**NOTES:**

- A. NO INDUSTRY STANDARD APPLIES TO THIS PACKAGE.
- B. DIMENSIONS ARE EXCLUSIVE OF BURRS, MOLD FLASH, AND TIE BAR EXTRUSIONS.
- C. ALL DIMENSIONS ARE IN MILLIMETERS.
- D. DRAWING CONFORMS TO ASME Y14.5-2009.

<b>DOCUMENT NUMBER:</b>	<b>98AON13852G</b>	Electronic versions are uncontrolled except when accessed directly from the Document Repository. Printed versions are uncontrolled except when stamped "CONTROLLED COPY" in red.
<b>DESCRIPTION:</b>	<b>TO-247-4LD</b>	<b>PAGE 1 OF 1</b>

onsemi and Onsemi are trademarks of Semiconductor Components Industries, LLC dba onsemi or its subsidiaries in the United States and/or other countries. onsemi reserves the right to make changes without further notice to any products herein. onsemi makes no warranty, representation or guarantee regarding the suitability of its products for any particular purpose, nor does onsemi assume any liability arising out of the application or use of any product or circuit, and specifically disclaims any and all liability, including without limitation special, consequential or incidental damages. onsemi does not convey any license under its patent rights nor the rights of others.

**onsemi**, **Onsemi**, and other names, marks, and brands are registered and/or common law trademarks of Semiconductor Components Industries, LLC dba "**onsemi**" or its affiliates and/or subsidiaries in the United States and/or other countries. **onsemi** owns the rights to a number of patents, trademarks, copyrights, trade secrets, and other intellectual property. A listing of **onsemi**'s product/patent coverage may be accessed at [www.onsemi.com/site/pdf/Patent-Marking.pdf](http://www.onsemi.com/site/pdf/Patent-Marking.pdf). **onsemi** reserves the right to make changes at any time to any products or information herein, without notice. The information herein is provided "as-is" and **onsemi** makes no warranty, representation or guarantee regarding the accuracy of the information, product features, availability, functionality, or suitability of its products for any particular purpose, nor does **onsemi** assume any liability arising out of the application or use of any product or circuit, and specifically disclaims any and all liability, including without limitation special, consequential or incidental damages. Buyer is responsible for its products and applications using **onsemi** products, including compliance with all laws, regulations and safety requirements or standards, regardless of any support or applications information provided by **onsemi**. "Typical" parameters which may be provided in **onsemi** data sheets and/or specifications can and do vary in different applications and actual performance may vary over time. All operating parameters, including "Typicals" must be validated for each customer application by customer's technical experts. **onsemi** does not convey any license under any of its intellectual property rights nor the rights of others. **onsemi** products are not designed, intended, or authorized for use as a critical component in life support systems or any FDA Class 3 medical devices or medical devices with a same or similar classification in a foreign jurisdiction or any devices intended for implantation in the human body. Should Buyer purchase or use **onsemi** products for any such unintended or unauthorized application, Buyer shall indemnify and hold **onsemi** and its officers, employees, subsidiaries, affiliates, and distributors harmless against all claims, costs, damages, and expenses, and reasonable attorney fees arising out of, directly or indirectly, any claim of personal injury or death associated with such unintended or unauthorized use, even if such claim alleges that **onsemi** was negligent regarding the design or manufacture of the part. **onsemi** is an Equal Opportunity/Affirmative Action Employer. This literature is subject to all applicable copyright laws and is not for resale in any manner.

## ADDITIONAL INFORMATION

### TECHNICAL PUBLICATIONS:

Technical Library: [www.onsemi.com/design/resources/technical-documentation](http://www.onsemi.com/design/resources/technical-documentation)  
onsemi Website: [www.onsemi.com](http://www.onsemi.com)

### ONLINE SUPPORT: [www.onsemi.com/support](http://www.onsemi.com/support)

For additional information, please contact your local Sales Representative at [www.onsemi.com/support/sales](http://www.onsemi.com/support/sales)