

NTUD3169CZ

MOSFET – Small Signal, Complementary, SOT-963, 1.0 x 1.0 mm

20 V, 220 mA / -200 mA



ON Semiconductor®

www.onsemi.com

Features

- Complementary MOSFET Device
- Offers a Low $R_{DS(on)}$ Solution in the Ultra Small 1.0x1.0 mm Package
- 1.5 V Gate Voltage Rating
- Ultra Thin Profile (< 0.5 mm) Allows It to Fit Easily into Extremely Thin Environments such as Portable Electronics.
- This is a Pb-Free Device

Applications

- Load Switch with Level Shift
- Optimized for Power Management in Ultra Portable Equipment

MAXIMUM RATINGS ($T_J = 25^\circ\text{C}$ unless otherwise specified)

Parameter		Symbol	Value	Unit
Drain-to-Source Voltage		V_{DSS}	20	V
Gate-to-Source Voltage		V_{GS}	± 8	V
N-Channel Continuous Drain Current (Note 1)	Steady State	$T_A = 25^\circ\text{C}$	220	mA
			$T_A = 85^\circ\text{C}$	
	$t \leq 5$ s	$T_A = 25^\circ\text{C}$	280	
			$T_A = 85^\circ\text{C}$	
P-Channel Continuous Drain Current (Note 1)	Steady State	$T_A = 25^\circ\text{C}$	-200	mA
			$T_A = 85^\circ\text{C}$	
	$t \leq 5$ s	$T_A = 25^\circ\text{C}$	-250	
Power Dissipation (Note 1)	Steady State	$T_A = 25^\circ\text{C}$	125	mW
			$t \leq 5$ s	
Pulsed Drain Current	N-Channel	$t_p = 10$ μs	800	mA
	P-Channel		-600	
Operating Junction and Storage Temperature		T_J, T_{STG}	-55 to 150	$^\circ\text{C}$
Source Current (Body Diode) (Note 2)		I_S	200	mA
Lead Temperature for Soldering Purposes (1/8" from case for 10 s)		T_L	260	$^\circ\text{C}$

Stresses exceeding those listed in the Maximum Ratings table may damage the device. If any of these limits are exceeded, device functionality should not be assumed, damage may occur and reliability may be affected.

1. Surface-mounted on FR4 board using the minimum recommended pad size, 1 oz. Cu.
2. Pulse Test: pulse width ≤ 300 μs , duty cycle $\leq 2\%$

$V_{(BR)DSS}$	$R_{DS(on)}$ Max	I_D Max
N-Channel 20 V	1.5 Ω @ 4.5 V	0.22 A
	2.0 Ω @ 2.5 V	
	3.0 Ω @ 1.8 V	
	4.5 Ω @ 1.5 V	
P-Channel 20 V	5.0 Ω @ -4.5 V	-0.2 A
	6.0 Ω @ -2.5 V	
	7.0 Ω @ -1.8 V	
	10 Ω @ -1.5 V	

PINOUT: SOT-963

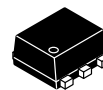
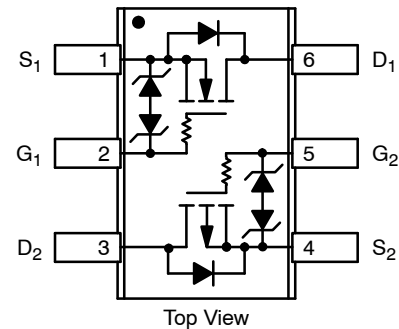

SOT-963
CASE 527AD

MARKING DIAGRAM

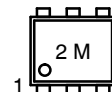

- 2 = Specific Device Code
- M = Date Code

ORDERING INFORMATION

Device	Package	Shipping†
NTUD3169CZT5G	SOT-963 (Pb-Free)	8000 / Tape & Reel

†For information on tape and reel specifications, including part orientation and tape sizes, please refer to our Tape and Reel Packaging Specifications Brochure, BRD8011/D.

NTUD3169CZ

THERMAL RESISTANCE RATINGS

Parameter	Symbol	Max	Unit
Junction-to-Ambient – Steady State, Minimum Pad (Note 3)	$R_{\theta JA}$	1000	°C/W
Junction-to-Ambient – $t \leq 5$ s (Note 3)		600	

3. Surface-mounted on FR4 board using the minimum recommended pad size, 1 oz. Cu.

ELECTRICAL CHARACTERISTICS ($T_J = 25^\circ\text{C}$ unless otherwise specified)

Parameter	Symbol	N/P	Test Condition	Min	Typ	Max	Unit
OFF CHARACTERISTICS							
Drain-to-Source Breakdown Voltage	$V_{(BR)DSS}$	N	$V_{GS} = 0\text{ V}$	$I_D = 250\ \mu\text{A}$	20		V
		P		$I_D = -250\ \mu\text{A}$	-20		
Zero Gate Voltage Drain Current	I_{DSS}	N	$V_{GS} = 0\text{ V}, V_{DS} = 5.0\text{ V}$	$T_J = 25^\circ\text{C}$		50	nA
				$T_J = 85^\circ\text{C}$		200	
		P		$T_J = 25^\circ\text{C}$		-50	
				$T_J = 85^\circ\text{C}$		-200	
Zero Gate Voltage Drain Current	I_{DSS}	N	$V_{GS} = 0\text{ V}, V_{DS} = 16\text{ V}$	$T_J = 25^\circ\text{C}$		100	nA
		P	$V_{GS} = 0\text{ V}, V_{DS} = -16\text{ V}$			-100	
Gate-to-Source Leakage Current	I_{GSS}	N	$V_{DS} = 0\text{ V}, V_{GS} = \pm 5.0\text{ V}$			± 100	nA
		P				± 100	

ON CHARACTERISTICS (Note 4)

Gate Threshold Voltage	$V_{GS(TH)}$	N	$V_{GS} = V_{DS}$	$I_D = 250\ \mu\text{A}$	0.4	1.0	V	
		P		$I_D = -250\ \mu\text{A}$	-0.4	-1.0		
Drain-to-Source On Resistance	$R_{DS(on)}$	N	$V_{GS} = 4.5\text{ V}, I_D = 100\text{ mA}$		0.75	1.5	Ω	
		P	$V_{GS} = -4.5\text{ V}, I_D = -100\text{ mA}$		2.0	5.0		
		N	$V_{GS} = 2.5\text{ V}, I_D = 50\text{ mA}$		1.0	2.0		
		P	$V_{GS} = -2.5\text{ V}, I_D = -50\text{ mA}$		2.6	6.0		
		N	$V_{GS} = 1.8\text{ V}, I_D = 20\text{ mA}$		1.4	3.0		
		P	$V_{GS} = -1.8\text{ V}, I_D = -20\text{ mA}$		3.4	7.0		
		N	$V_{GS} = 1.5\text{ V}, I_D = 10\text{ mA}$		1.8	4.5		
		P	$V_{GS} = -1.5\text{ V}, I_D = -10\text{ mA}$		4.0	10		
		N	$V_{GS} = 1.2\text{ V}, I_D = 1.0\text{ mA}$		2.8			
		P	$V_{GS} = -1.2\text{ V}, I_D = -1.0\text{ mA}$		6.0			
Forward Transconductance	g_{FS}	N	$V_{DS} = 5.0\text{ V}, I_D = 125\text{ mA}$		0.48		S	
		P	$V_{DS} = -5.0\text{ V}, I_D = -125\text{ mA}$		0.35			
Source-Drain Diode Voltage	V_{SD}	N	$V_{GS} = 0\text{ V}, I_S = 10\text{ mA}$	$T_J = 25^\circ\text{C}$		0.6	1.0	V
		P	$V_{GS} = 0\text{ V}, I_S = -10\text{ mA}$			-0.6	-1.0	

CAPACITANCES

Input Capacitance	C_{ISS}	N	$f = 1\text{ MHz}, V_{GS} = 0\text{ V}$ $V_{DS} = 15\text{ V}$		12.5		pF
Output Capacitance	C_{OSS}				3.6		
Reverse Transfer Capacitance	C_{RSS}				2.6		
Input Capacitance	C_{ISS}	P	$f = 1\text{ MHz}, V_{GS} = 0\text{ V}$ $V_{DS} = -15\text{ V}$		13.5		pF
Output Capacitance	C_{OSS}				3.8		
Reverse Transfer Capacitance	C_{RSS}				2.0		

4. Switching characteristics are independent of operating junction temperatures

NTUD3169CZ

ELECTRICAL CHARACTERISTICS ($T_J = 25^\circ\text{C}$ unless otherwise specified)

Parameter	Symbol	N/P	Test Condition	Min	Typ	Max	Unit
SWITCHING CHARACTERISTICS, $V_{GS} = 4.5\text{ V}$ (Note 4)							
Turn-On Delay Time	$t_{d(ON)}$	N	$V_{GS} = 4.5\text{ V}, V_{DD} = 10\text{ V}, I_D = 200\text{ mA}, R_G = 2.0\ \Omega$		16.5		ns
Rise Time	t_r				25.5		
Turn-Off Delay Time	$t_{d(OFF)}$				142		
Fall Time	t_f				80		
Turn-On Delay Time	$t_{d(ON)}$	P	$V_{GS} = -4.5\text{ V}, V_{DD} = -15\text{ V}, I_D = -200\text{ mA}, R_G = 2.0\ \Omega$		26		
Rise Time	t_r				46		
Turn-Off Delay Time	$t_{d(OFF)}$				196		
Fall Time	t_f				145		

4. Switching characteristics are independent of operating junction temperatures

TYPICAL CHARACTERISTICS (N-CHANNEL)

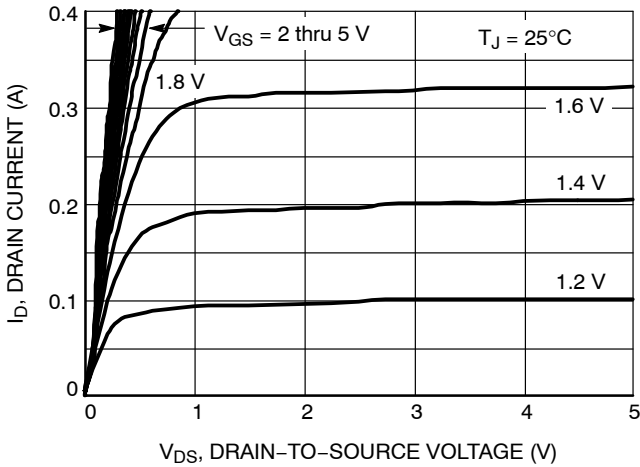

Figure 1. On-Region Characteristics

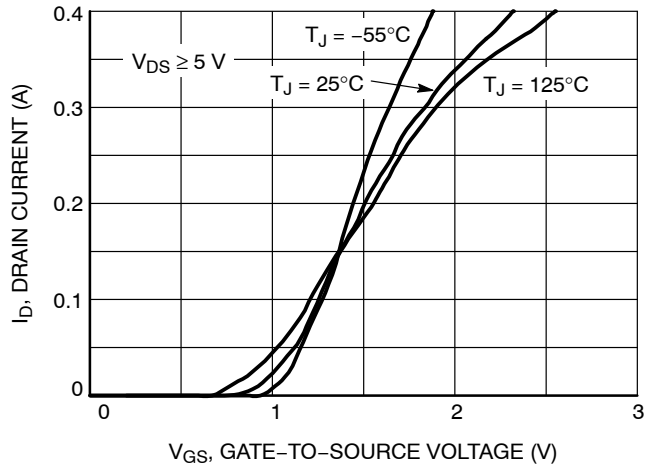

Figure 2. Transfer Characteristics

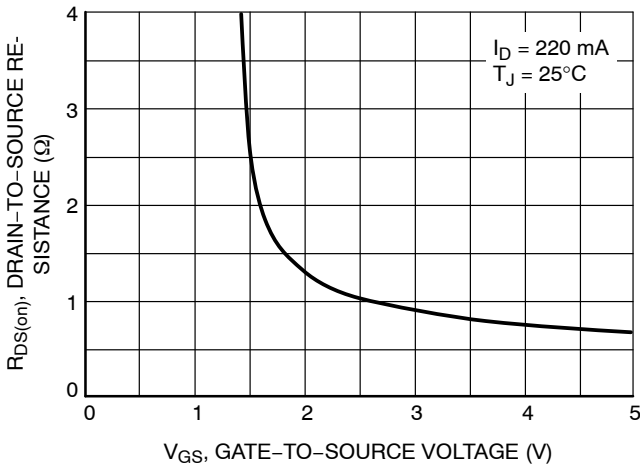

Figure 3. On-Resistance vs. Gate Voltage

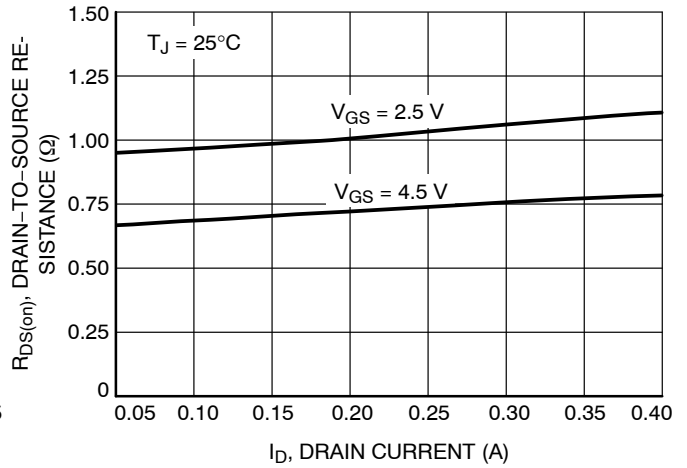

Figure 4. On-Resistance vs. Drain Current and Gate Voltage

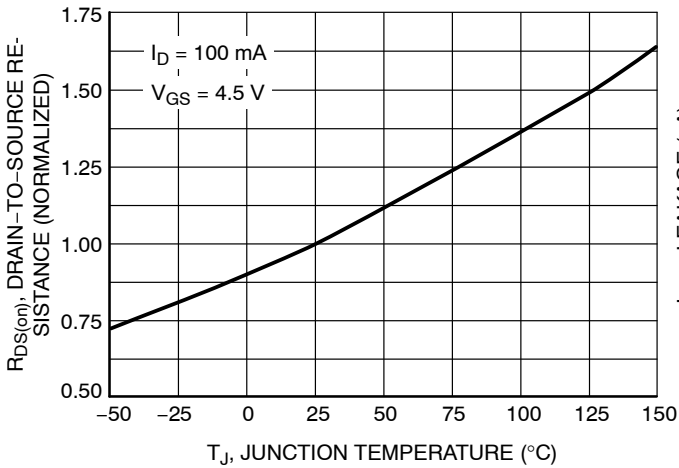

Figure 5. On-Resistance Variation with Temperature

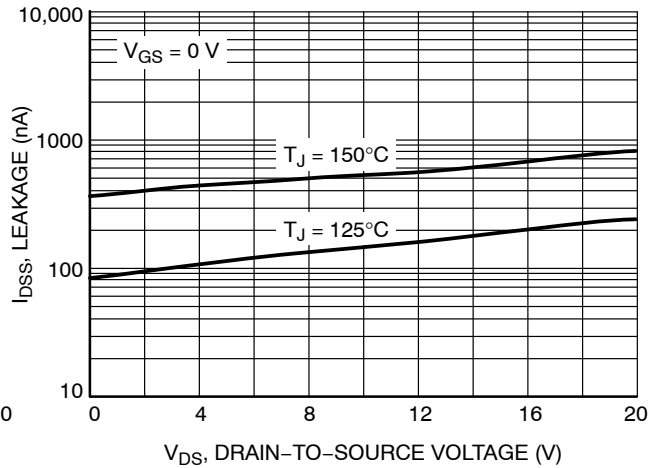

Figure 6. Drain-to-Source Leakage Current vs. Voltage

NTUD3169CZ

TYPICAL CHARACTERISTICS (N-CHANNEL)

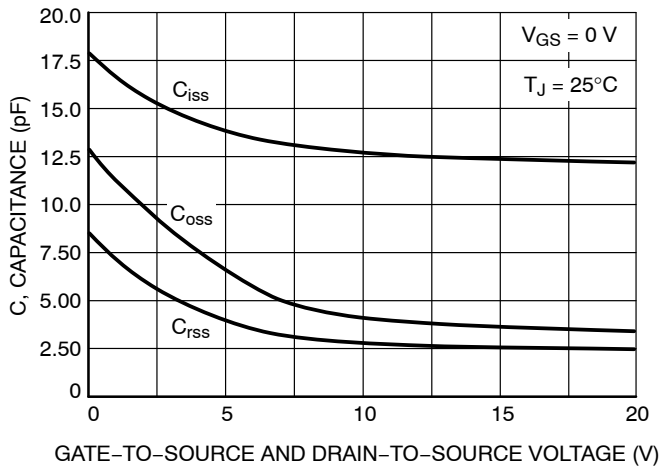

Figure 7. Capacitance Variation

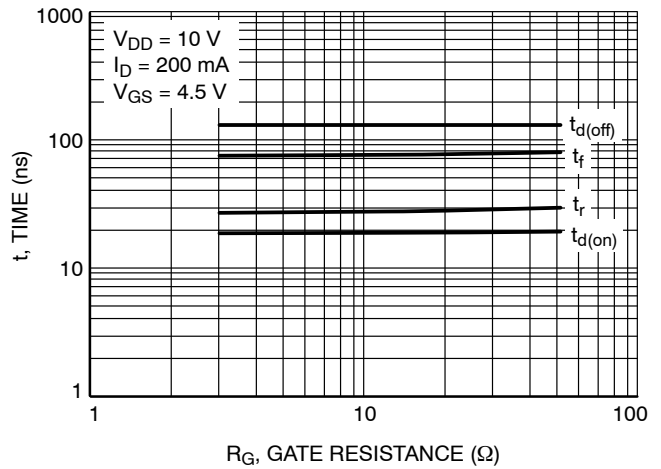

Figure 8. Resistive Switching Time Variation vs. Gate Resistance

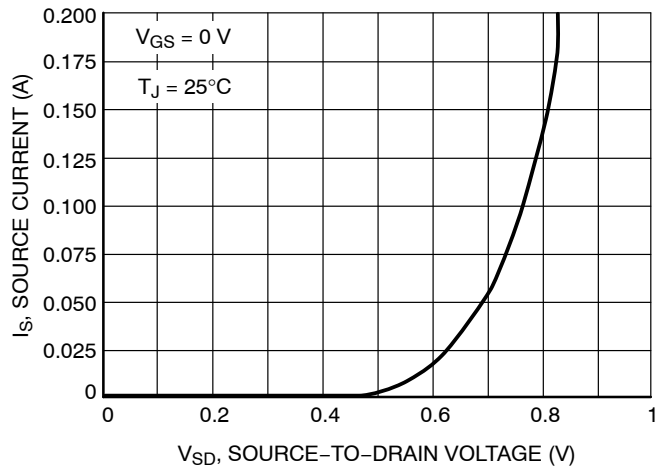

Figure 9. Diode Forward Voltage vs. Current

TYPICAL CHARACTERISTICS (P-CHANNEL)

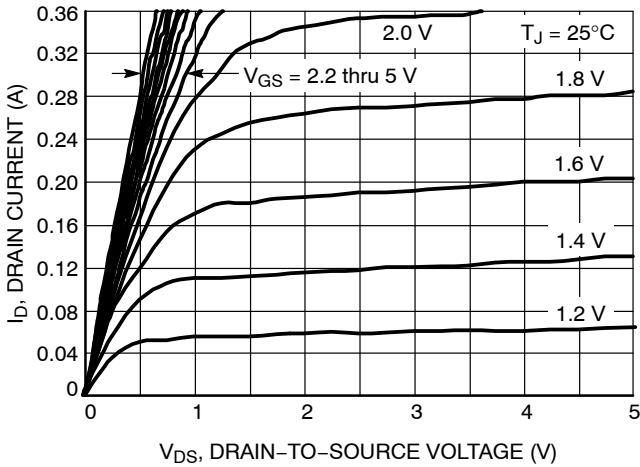

Figure 10. On-Region Characteristics

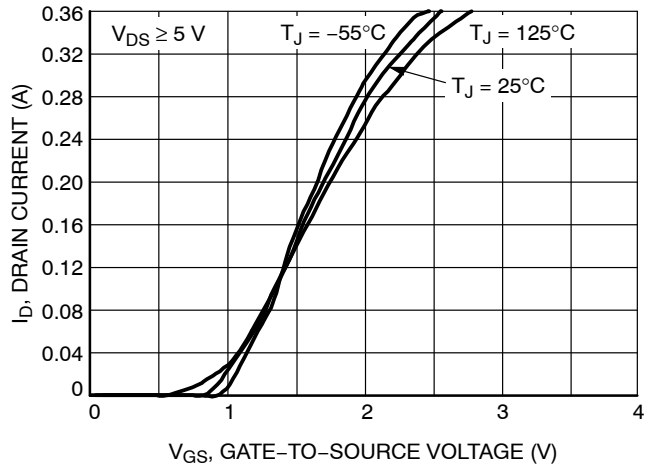

Figure 11. Transfer Characteristics

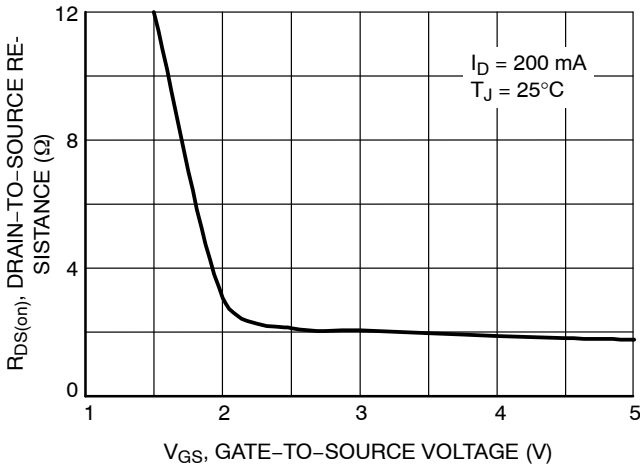

Figure 12. On-Resistance vs. Gate Voltage

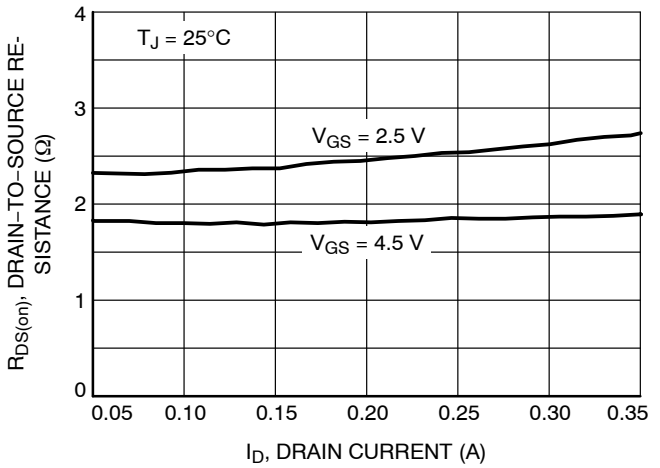

Figure 13. On-Resistance vs. Drain Current and Gate Voltage

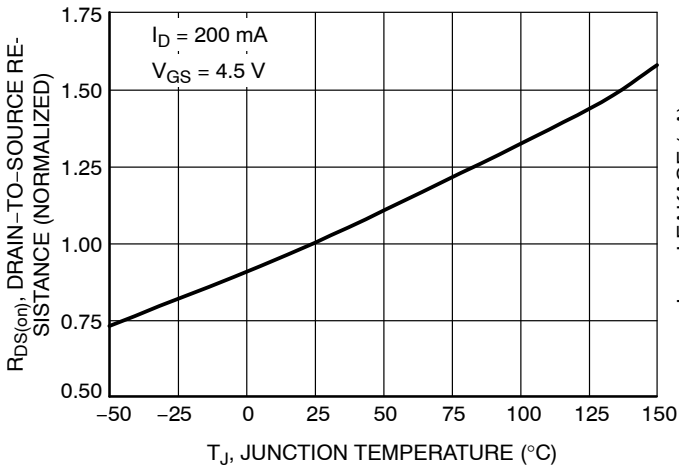

Figure 14. On-Resistance Variation with Temperature

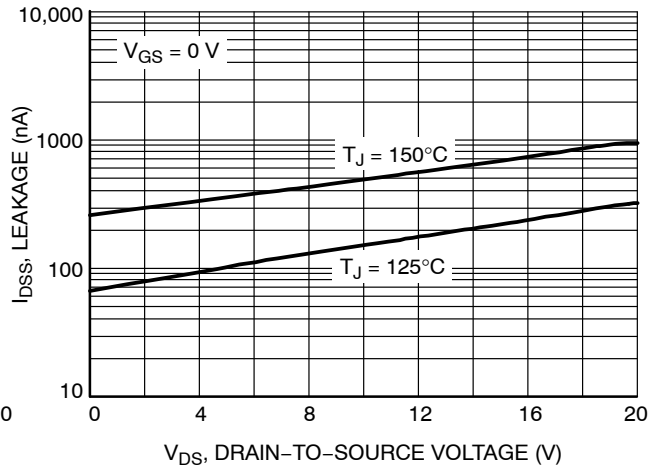

Figure 15. Drain-to-Source Leakage Current vs. Voltage

NTUD3169CZ

TYPICAL CHARACTERISTICS (P-CHANNEL)

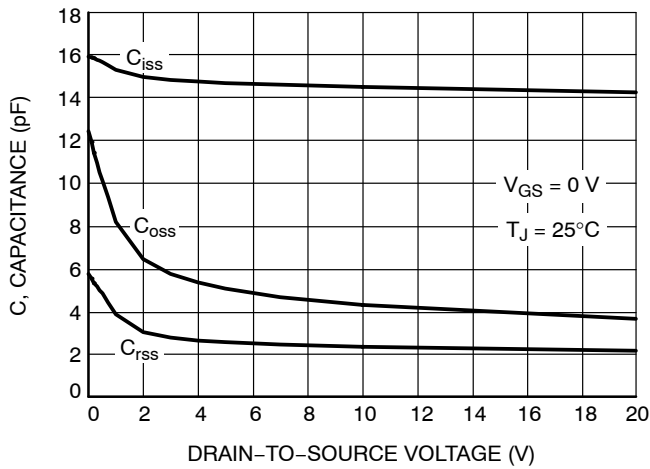

Figure 16. Capacitance Variation

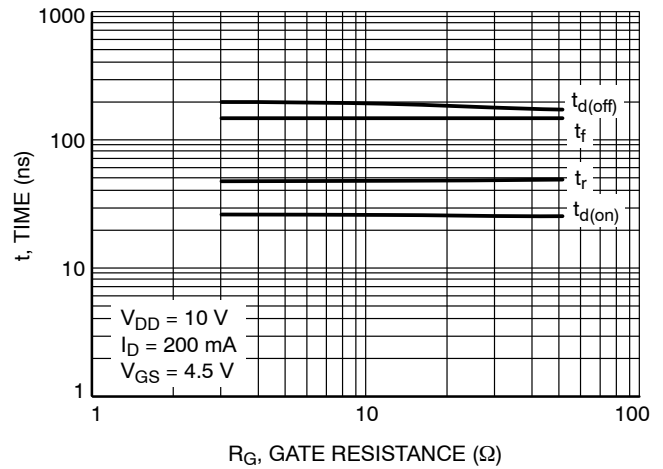

Figure 17. Resistive Switching Time Variation vs. Gate Resistance

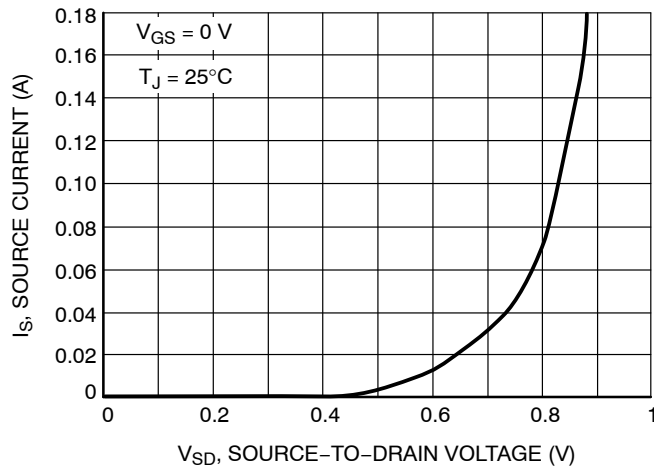
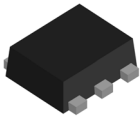

Figure 18. Diode Forward Voltage vs. Current

MECHANICAL CASE OUTLINE

PACKAGE DIMENSIONS



SOT-963 1.00x1.00x0.37, 0.35P
CASE 527AD
ISSUE F

DATE 20 FEB 2024

NOTES:

1. DIMENSIONING AND TOLERANCING PER ASME Y14.5M, 2018.
2. CONTROLLING DIMENSION: MILLIMETERS.
3. MAXIMUM LEAD THICKNESS INCLUDES LEAD FINISH THICKNESS. MINIMUM LEAD THICKNESS IS THE MINIMUM THICKNESS OF BASE MATERIAL.
4. DIMENSIONS D AND E DO NOT INCLUDE MOLD FLASH, PROTRUSIONS, OR GATE BURRS.

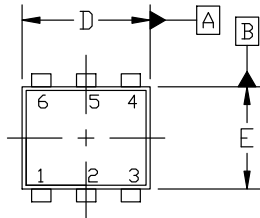

TOP VIEW

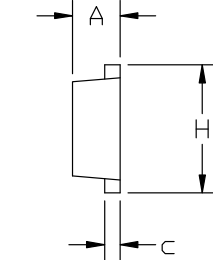

SIDE VIEW

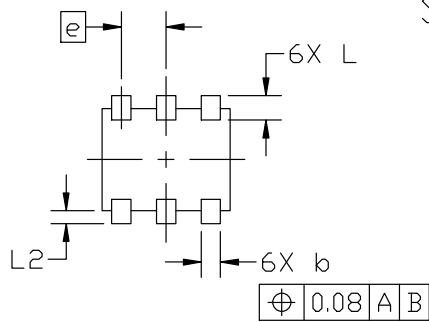

BOTTOM VIEW

DIM	MILLIMETERS		
	MIN.	NOM.	MAX.
A	0.34	0.37	0.40
b	0.10	0.15	0.20
c	0.07	0.12	0.17
D	0.95	1.00	1.05
E	0.75	0.80	0.85
e	0.35 BSC		
H	0.95	1.00	1.05
L	0.19 REF		
L2	0.05	0.10	0.15

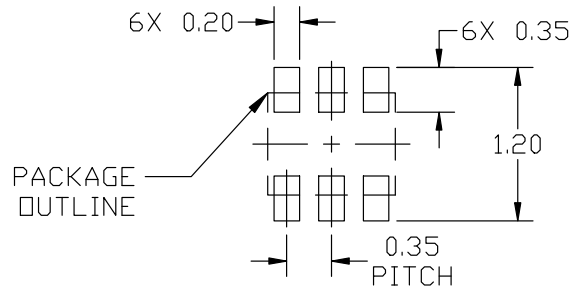

RECOMMENDED MOUNTING FOOTPRINT

*For additional information on our Pb-Free strategy and soldering details, please download the ON Semiconductor Soldering and Mounting Techniques Reference manual, SOLDERRM/D.

STYLE 1:

- PIN 1. EMITTER 1
- 2. BASE 1
- 3. COLLECTOR 2
- 4. EMITTER 2
- 5. BASE 2
- 6. COLLECTOR 1

STYLE 2:

- PIN 1. EMITTER 1
- 2. EMITTER2
- 3. BASE 2
- 4. COLLECTOR 2
- 5. BASE 1
- 6. COLLECTOR 1

STYLE 3:

- PIN 1. CATHODE 1
- 2. CATHODE 1
- 3. ANODE/ANODE 2
- 4. CATHODE 2
- 5. CATHODE 2
- 6. ANODE/ANODE 1

STYLE 4:

- PIN 1. COLLECTOR
- 2. COLLECTOR
- 3. BASE
- 4. EMITTER
- 5. COLLECTOR
- 6. COLLECTOR

STYLE 5:

- PIN 1. CATHODE
- 2. CATHODE
- 3. ANODE
- 4. ANODE
- 5. CATHODE
- 6. CATHODE

STYLE 6:

- PIN 1. CATHODE
- 2. ANODE
- 3. CATHODE
- 4. CATHODE
- 5. CATHODE
- 6. CATHODE

STYLE 7:

- PIN 1. CATHODE
- 2. ANODE
- 3. CATHODE
- 4. CATHODE
- 5. ANODE
- 6. CATHODE

STYLE 8:

- PIN 1. DRAIN
- 2. DRAIN
- 3. GATE
- 4. SOURCE
- 5. DRAIN
- 6. DRAIN

STYLE 9:

- PIN 1. SOURCE 1
- 2. GATE 1
- 3. DRAIN 2
- 4. SOURCE 2
- 5. GATE 2
- 6. DRAIN 1

STYLE 10:

- PIN 1. CATHODE 1
- 2. N/C
- 3. CATHODE 2
- 4. ANODE 2
- 5. N/C
- 6. ANODE 1

GENERIC MARKING DIAGRAM*

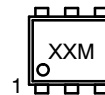

XX = Specific Device Code
M = Month Code

*This information is generic. Please refer to device data sheet for actual part marking. Pb-Free indicator, "G" or microdot "•", may or may not be present. Some products may not follow the Generic Marking.

DOCUMENT NUMBER:	98AON26456D	Electronic versions are uncontrolled except when accessed directly from the Document Repository. Printed versions are uncontrolled except when stamped "CONTROLLED COPY" in red.
DESCRIPTION:	SOT-963 1.00x1.00x0.37, 0.35P	PAGE 1 OF 1

onsemi and ONSEMI are trademarks of Semiconductor Components Industries, LLC dba onsemi or its subsidiaries in the United States and/or other countries. onsemi reserves the right to make changes without further notice to any products herein. onsemi makes no warranty, representation or guarantee regarding the suitability of its products for any particular purpose, nor does onsemi assume any liability arising out of the application or use of any product or circuit, and specifically disclaims any and all liability, including without limitation special, consequential or incidental damages. onsemi does not convey any license under its patent rights nor the rights of others.

onsemi, **Onsemi**, and other names, marks, and brands are registered and/or common law trademarks of Semiconductor Components Industries, LLC dba "**onsemi**" or its affiliates and/or subsidiaries in the United States and/or other countries. **onsemi** owns the rights to a number of patents, trademarks, copyrights, trade secrets, and other intellectual property. A listing of **onsemi**'s product/patent coverage may be accessed at www.onsemi.com/site/pdf/Patent-Marking.pdf. **onsemi** reserves the right to make changes at any time to any products or information herein, without notice. The information herein is provided "as-is" and **onsemi** makes no warranty, representation or guarantee regarding the accuracy of the information, product features, availability, functionality, or suitability of its products for any particular purpose, nor does **onsemi** assume any liability arising out of the application or use of any product or circuit, and specifically disclaims any and all liability, including without limitation special, consequential or incidental damages. Buyer is responsible for its products and applications using **onsemi** products, including compliance with all laws, regulations and safety requirements or standards, regardless of any support or applications information provided by **onsemi**. "Typical" parameters which may be provided in **onsemi** data sheets and/or specifications can and do vary in different applications and actual performance may vary over time. All operating parameters, including "Typicals" must be validated for each customer application by customer's technical experts. **onsemi** does not convey any license under any of its intellectual property rights nor the rights of others. **onsemi** products are not designed, intended, or authorized for use as a critical component in life support systems or any FDA Class 3 medical devices or medical devices with a same or similar classification in a foreign jurisdiction or any devices intended for implantation in the human body. Should Buyer purchase or use **onsemi** products for any such unintended or unauthorized application, Buyer shall indemnify and hold **onsemi** and its officers, employees, subsidiaries, affiliates, and distributors harmless against all claims, costs, damages, and expenses, and reasonable attorney fees arising out of, directly or indirectly, any claim of personal injury or death associated with such unintended or unauthorized use, even if such claim alleges that **onsemi** was negligent regarding the design or manufacture of the part. **onsemi** is an Equal Opportunity/Affirmative Action Employer. This literature is subject to all applicable copyright laws and is not for resale in any manner.

ADDITIONAL INFORMATION

TECHNICAL PUBLICATIONS:

Technical Library: www.onsemi.com/design/resources/technical-documentation
onsemi Website: www.onsemi.com

ONLINE SUPPORT: www.onsemi.com/support

For additional information, please contact your local Sales Representative at www.onsemi.com/support/sales