

# NVC6S5A444NLZ

## Power MOSFET

60 V, 78 mΩ, 4.5 A, N-Channel

Automotive Power MOSFET designed to minimize gate charge and low on resistance. AEC-Q101 qualified MOSFET and PPAP capable suitable for automotive applications.

### Features

- 4.5 V Drive
- High ESD Protection
- Low On-Resistance
- CPH6 Package is Pin-Compatible with SOT-26
- Pb-Free, Halogen Free and RoHS Compliance

### Typical Applications

- Load Switch
- Motor Drive

### Specifications

#### ABSOLUTE MAXIMUM RATINGS (T<sub>a</sub> = 25°C)

| Parameter  | Symbol                            | Value       | Unit |
|--|-----------------------------------|-------------|------|
| Drain to Source Voltage                              | V <sub>DSS</sub>                  | 60          | V    |
| Gate to Source Voltage                               | V <sub>GSS</sub>                  | ±20         | V    |
| Drain Current (DC) (Note 1)                          | I <sub>D</sub>                    | 4.5         | A    |
| Drain Current (DC) (Note 2)                          |                                   | 3.5         | A    |
| Drain Current (Pulse)<br>PW ≤ 10 μs, duty cycle ≤ 1% | I <sub>DP</sub>                   | 18          | A    |
| Power Dissipation<br>T <sub>a</sub> = 25°C (Note 1)  | P <sub>D</sub>                    | 1.9         | W    |
| Power Dissipation<br>T <sub>a</sub> = 25°C (Note 2)  |                                   | 0.97        | W    |
| Junction Temperature and Storage Temperature         | T <sub>J</sub> , T <sub>stg</sub> | -55 to +175 | °C   |

Stresses exceeding those listed in the Maximum Ratings table may damage the device. If any of these limits are exceeded, device functionality should not be assumed, damage may occur and reliability may be affected.

#### THERMAL RESISTANCE MAXIMUM RATINGS

| Parameter           | Symbol   | Value            | Unit      |
|---------------------|----------|------------------|-----------|
| Junction to Ambient | (Note 1) | R <sub>θJA</sub> | 78.1 °C/W |
|                     | (Note 2) |                  | 153 °C/W  |

1. Surface mounted on ceramic substrate (900 mm<sup>2</sup> × 0.8 mm).
2. Surface mounted on FR4 board using a 92 mm<sup>2</sup>, 1 oz. Cu pad.



ON Semiconductor®

[www.onsemi.com](http://www.onsemi.com)

| V <sub>DSS</sub> | R <sub>DS(on)</sub> MAX | I <sub>D</sub> MAX |
|------------------|-------------------------|--------------------|
| 60 V             | 78 mΩ @ 10 V            | 4.5 A              |
|                  | 120 mΩ @ 4.5 V          |                    |

### ELECTRICAL CONNECTION N-Channel

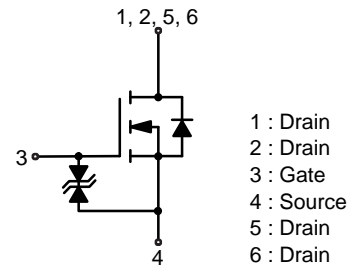

### MARKING DIAGRAM

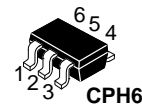

CASE 318BD

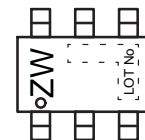

### ORDERING INFORMATION

See detailed ordering, marking and shipping information in the package dimensions section on page 5 of this data sheet.

# NVC6S5A444NLZ

## ELECTRICAL CHARACTERISTICS ( $T_a = 25^\circ\text{C}$ )

| Parameter                                  | Symbol        | Conditions  | Min | Typ  | Max      | Unit             |
|--|---------------|---|-----|------|----------|------------------|
| Drain to Source Breakdown Voltage          | $V_{(BR)DSS}$ | $I_D = 1 \text{ mA}, V_{GS} = 0 \text{ V}$                          | 60  | –    | –        | V                |
| Zero-Gate Voltage Drain Current            | $I_{DSS}$     | $V_{DS} = 60 \text{ V}, V_{GS} = 0 \text{ V}$                       | –   | –    | 1.0      | $\mu\text{A}$    |
| Gate to Source Leakage Current             | $I_{GSS}$     | $V_{GS} = \pm 16 \text{ V}, V_{DS} = 0 \text{ V}$                   | –   | –    | $\pm 10$ | $\mu\text{A}$    |
| Gate Threshold Voltage                     | $V_{GS(th)}$  | $V_{DS} = 10 \text{ V}, I_D = 1 \text{ mA}$                         | 1.2 | –    | 2.6      | V                |
| Forward Transconductance                   | $g_{FS}$      | $V_{DS} = 10 \text{ V}, I_D = 2 \text{ A}$                          | –   | 3.0  | –        | S                |
| Static Drain to Source On-State Resistance | $R_{DS(on)}$  | $I_D = 2 \text{ A}, V_{GS} = 10 \text{ V}$                          | –   | 60   | 78       | $\text{m}\Omega$ |
|  |               | $I_D = 1 \text{ A}, V_{GS} = 4.5 \text{ V}$                         | –   | 84   | 120      | $\text{m}\Omega$ |
| Input Capacitance                          | $C_{iss}$     | $V_{DS} = 20 \text{ V}, f = 1 \text{ MHz}$                          | –   | 505  | –        | $\text{pF}$      |
| Output Capacitance                         | $C_{oss}$     |   | –   | 57   | –        | $\text{pF}$      |
| Reverse Transfer Capacitance               | $C_{rss}$     |   | –   | 37   | –        | $\text{pF}$      |
| Turn-ON Delay Time                         | $t_d(on)$     | See Figure 1  | –   | 7.3  | –        | ns               |
| Rise Time                                  | $t_r$         |   | –   | 9.8  | –        | ns               |
| Turn-OFF Delay Time                        | $t_d(off)$    |   | –   | 40   | –        | ns               |
| Fall Time                                  | $t_f$         |   | –   | 24   | –        | ns               |
| Total Gate Charge                          | $Q_g$         | $V_{DS} = 30 \text{ V}, V_{GS} = 10 \text{ V}, I_D = 4.5 \text{ A}$ | –   | 10   | –        | nC               |
| Gate to Source Charge                      | $Q_{gs}$      |   | –   | 1.6  | –        | nC               |
| Gate to Drain "Miller" Charge              | $Q_{gd}$      |   | –   | 2.1  | –        | nC               |
| Forward Diode Voltage                      | $V_{SD}$      | $I_S = 4.5 \text{ A}, V_{GS} = 0 \text{ V}$                         | –   | 0.86 | 1.2      | V                |

Product parametric performance is indicated in the Electrical Characteristics for the listed test conditions, unless otherwise noted. Product performance may not be indicated by the Electrical Characteristics if operated under different conditions.

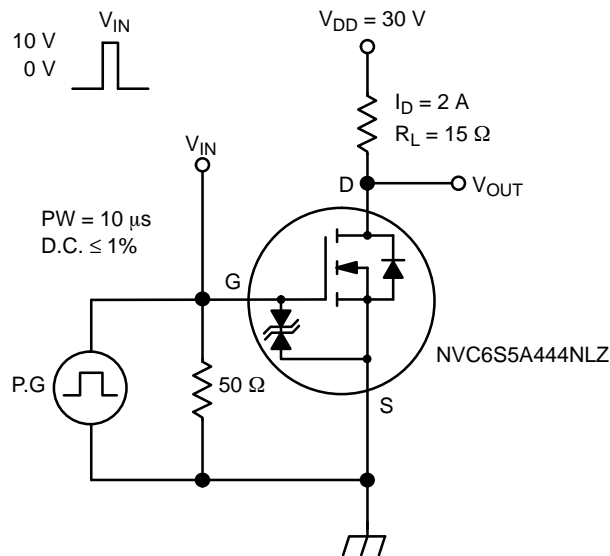

Figure 1. Switching Time Test Circuit

# NVC6S5A444NLZ

## TYPICAL CHARACTERISTICS

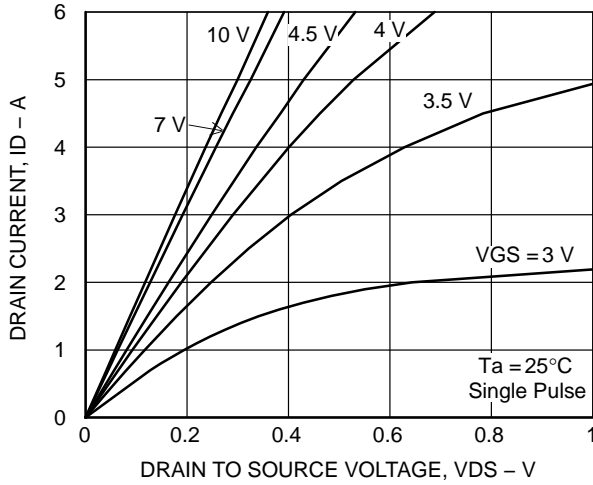

Figure 2.  $I_D - V_{DS}$

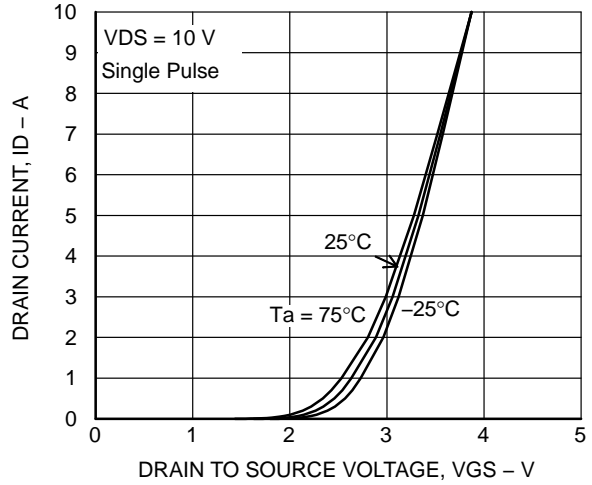

Figure 3.  $I_D - V_{GS}$

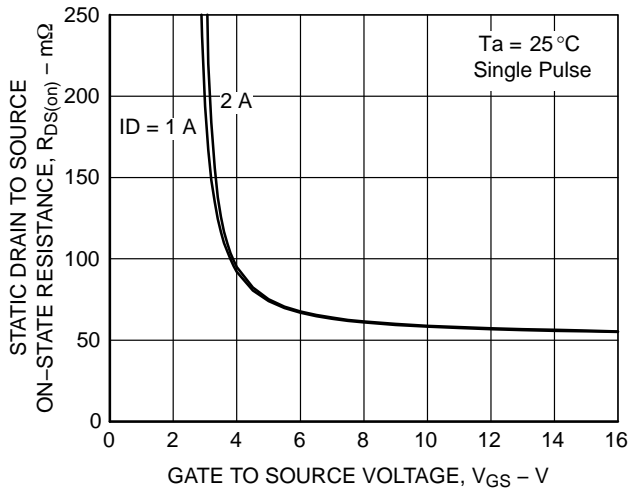

Figure 4.  $R_{DS(on)} - V_{GS}$

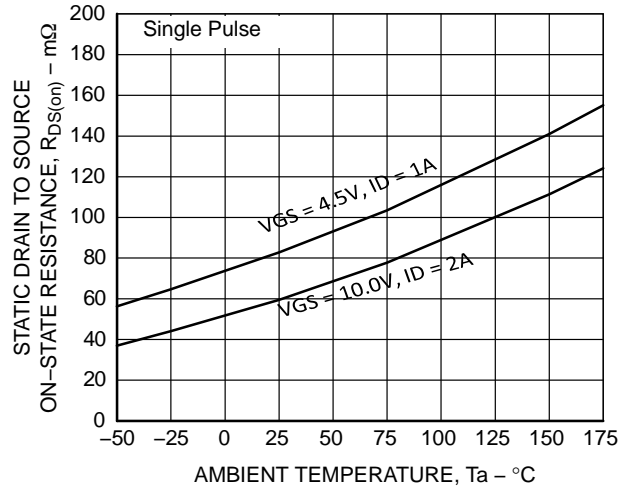

Figure 5.  $R_{DS(on)} - T_a$

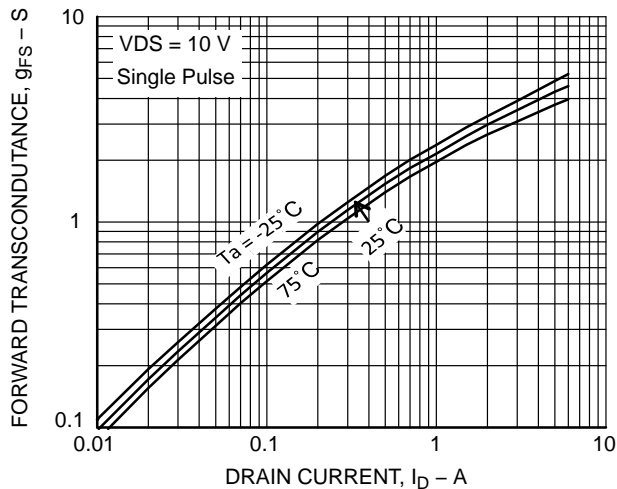

Figure 6.  $g_{FS} - I_D$

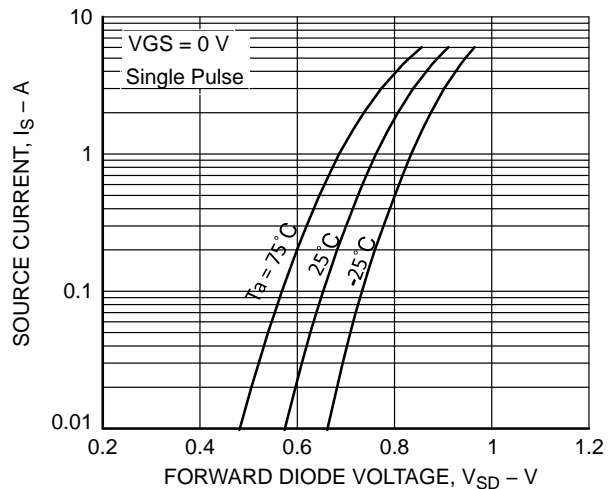

Figure 7.  $I_S - V_{SD}$

# NVC6S5A444NLZ

## TYPICAL CHARACTERISTICS

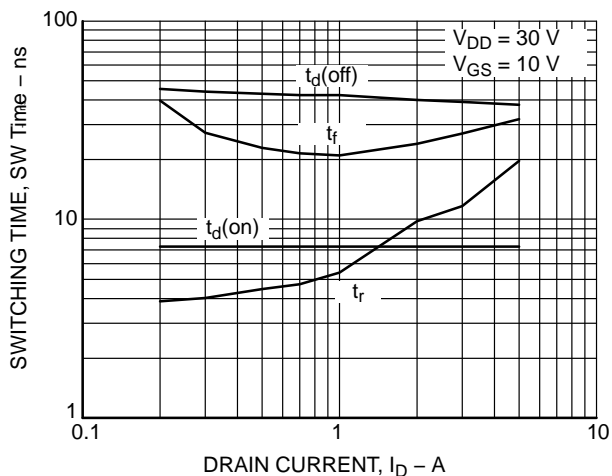

Figure 8. SW TIME -  $I_D$

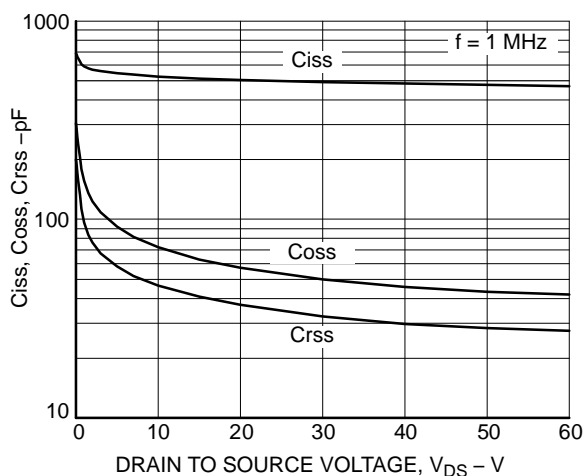

Figure 9. Ciss, Coss, Crss -  $V_{DS}$

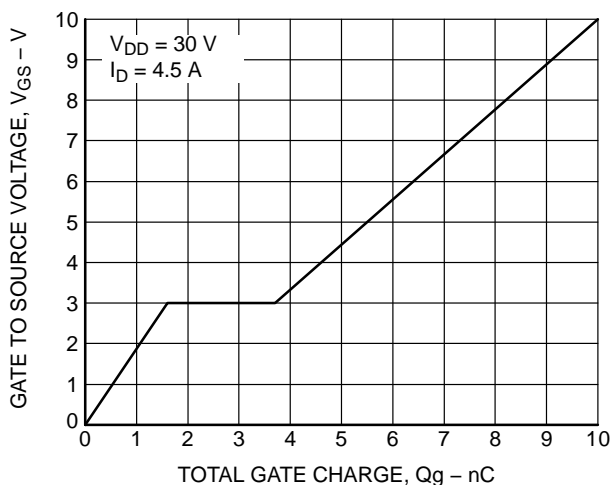

Figure 10.  $V_{GS}$  -  $Q_g$

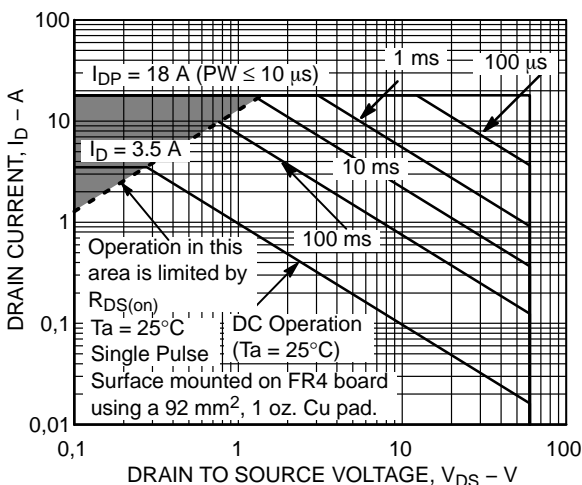

Figure 11. SOA

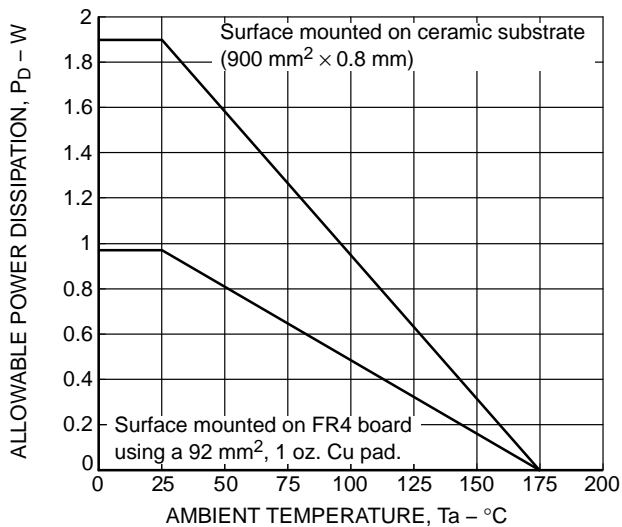

Figure 12.  $P_D$  -  $T_a$

# NVC6S5A444NLZ

## TYPICAL CHARACTERISTICS

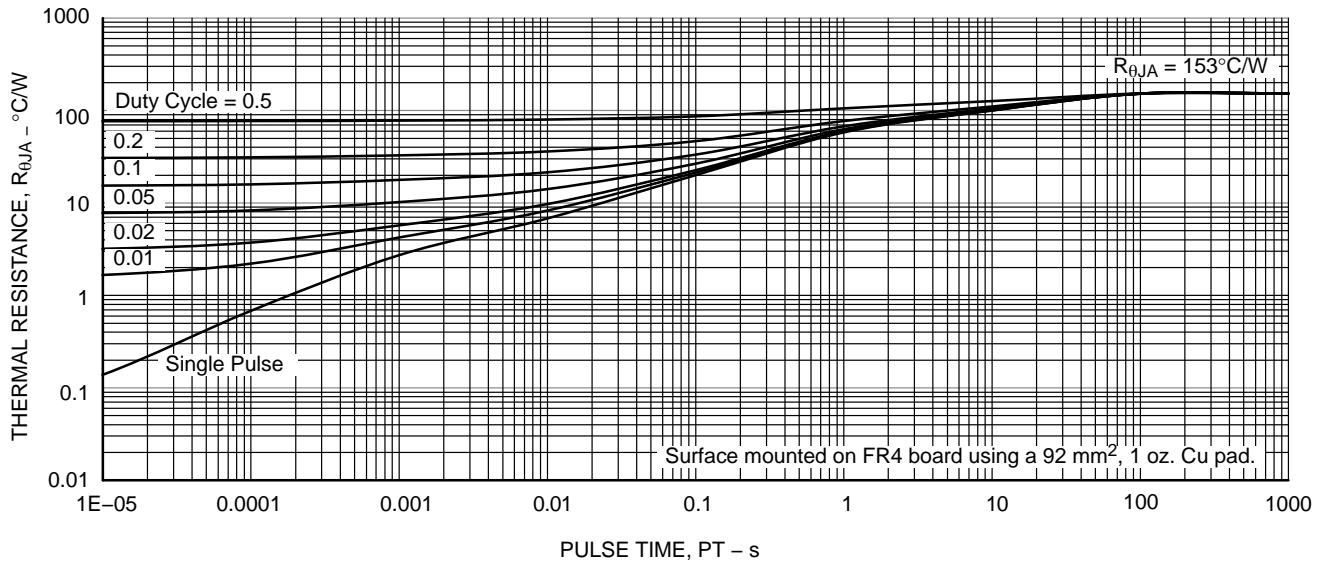

Figure 13.  $R_{\theta JA}$  – PULSE TIME

### DEVICE ORDERING INFORMATION

| Device           | Marking | Package                          | Shipping†           |
|------------------|---------|----------------------------------|---------------------|
| NVC6S5A444NLZT1G | ZW      | CPH6<br>(Pb-Free / Halogen Free) | 3,000 / Tape & Reel |
| NVC6S5A444NLZT2G |         |                                  |                     |

†For information on tape and reel specifications, including part orientation and tape sizes, please refer to our Tape and Reel Packaging Specifications Brochure, BRD8011/D.

Since the NVC6S5A444NLZ is a MOSFET product, please avoid using this device in the vicinity of highly charged objects.

**MECHANICAL CASE OUTLINE**  
**PACKAGE DIMENSIONS**

**CPH6**  
**CASE 318BD**  
**ISSUE O**

DATE 30 NOV 2011

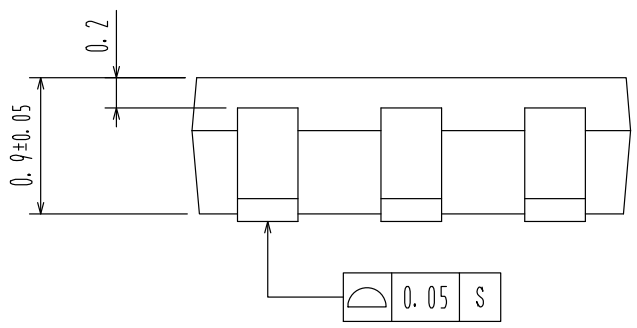
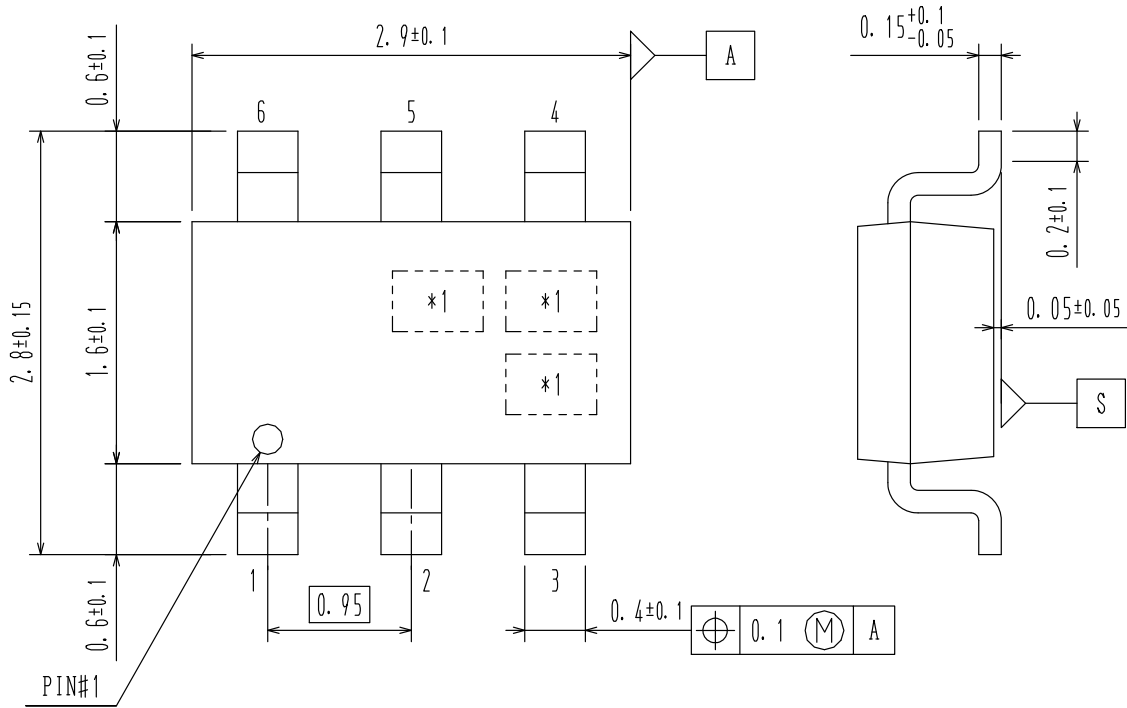

|                         |                    |  |
|-------------------------|--------------------|--|
| <b>DOCUMENT NUMBER:</b> | <b>98AON65440E</b> | Electronic versions are uncontrolled except when accessed directly from the Document Repository. Printed versions are uncontrolled except when stamped "CONTROLLED COPY" in red. |
| <b>DESCRIPTION:</b>     | <b>CPH6</b>        | <b>PAGE 1 OF 1</b>   |

ON Semiconductor and **ON** are trademarks of Semiconductor Components Industries, LLC dba ON Semiconductor or its subsidiaries in the United States and/or other countries. ON Semiconductor reserves the right to make changes without further notice to any products herein. ON Semiconductor makes no warranty, representation or guarantee regarding the suitability of its products for any particular purpose, nor does ON Semiconductor assume any liability arising out of the application or use of any product or circuit, and specifically disclaims any and all liability, including without limitation special, consequential or incidental damages. ON Semiconductor does not convey any license under its patent rights nor the rights of others.

**onsemi**, **Onsemi**, and other names, marks, and brands are registered and/or common law trademarks of Semiconductor Components Industries, LLC dba "**onsemi**" or its affiliates and/or subsidiaries in the United States and/or other countries. **onsemi** owns the rights to a number of patents, trademarks, copyrights, trade secrets, and other intellectual property. A listing of **onsemi**'s product/patent coverage may be accessed at [www.onsemi.com/site/pdf/Patent-Marking.pdf](http://www.onsemi.com/site/pdf/Patent-Marking.pdf). **onsemi** reserves the right to make changes at any time to any products or information herein, without notice. The information herein is provided "as-is" and **onsemi** makes no warranty, representation or guarantee regarding the accuracy of the information, product features, availability, functionality, or suitability of its products for any particular purpose, nor does **onsemi** assume any liability arising out of the application or use of any product or circuit, and specifically disclaims any and all liability, including without limitation special, consequential or incidental damages. Buyer is responsible for its products and applications using **onsemi** products, including compliance with all laws, regulations and safety requirements or standards, regardless of any support or applications information provided by **onsemi**. "Typical" parameters which may be provided in **onsemi** data sheets and/or specifications can and do vary in different applications and actual performance may vary over time. All operating parameters, including "Typicals" must be validated for each customer application by customer's technical experts. **onsemi** does not convey any license under any of its intellectual property rights nor the rights of others. **onsemi** products are not designed, intended, or authorized for use as a critical component in life support systems or any FDA Class 3 medical devices or medical devices with a same or similar classification in a foreign jurisdiction or any devices intended for implantation in the human body. Should Buyer purchase or use **onsemi** products for any such unintended or unauthorized application, Buyer shall indemnify and hold **onsemi** and its officers, employees, subsidiaries, affiliates, and distributors harmless against all claims, costs, damages, and expenses, and reasonable attorney fees arising out of, directly or indirectly, any claim of personal injury or death associated with such unintended or unauthorized use, even if such claim alleges that **onsemi** was negligent regarding the design or manufacture of the part. **onsemi** is an Equal Opportunity/Affirmative Action Employer. This literature is subject to all applicable copyright laws and is not for resale in any manner.

## ADDITIONAL INFORMATION

### TECHNICAL PUBLICATIONS:

Technical Library: [www.onsemi.com/design/resources/technical-documentation](http://www.onsemi.com/design/resources/technical-documentation)  
onsemi Website: [www.onsemi.com](http://www.onsemi.com)

### ONLINE SUPPORT: [www.onsemi.com/support](http://www.onsemi.com/support)

For additional information, please contact your local Sales Representative at [www.onsemi.com/support/sales](http://www.onsemi.com/support/sales)