

# MOSFET - Power, Single N-Channel

## 60 V, 24 mΩ, 20 A

### NVTFS5826NL

#### Features

- Small Footprint (3.3 x 3.3 mm) for Compact Design
- Low  $R_{DS(on)}$  to Minimize Conduction Losses
- Low Capacitance to Minimize Driver Losses
- NVTFS5826NLWF – Wettable Flanks Product
- AEC-Q101 Qualified and PPAP Capable
- These Devices are Pb-Free and are RoHS Compliant

#### MAXIMUM RATINGS ( $T_J = 25^\circ\text{C}$ unless otherwise noted)

Parameter	Symbol	Value	Unit	
Drain-to-Source Voltage	$V_{DSS}$	60	V	
Gate-to-Source Voltage	$V_{GS}$	$\pm 20$	V	
Continuous Drain Current $R_{\Psi J-mb}$ (Notes 1, 2, 3, 4)	Steady State	$T_{mb} = 25^\circ\text{C}$	$I_D$ 20	A
		$T_{mb} = 100^\circ\text{C}$	14	
Power Dissipation $R_{\Psi J-mb}$ (Notes 1, 2, 3)	Steady State	$T_{mb} = 25^\circ\text{C}$	$P_D$ 22	W
		$T_{mb} = 100^\circ\text{C}$	11	
Continuous Drain Current $R_{\theta JA}$ (Notes 1 & 3, 4)	Steady State	$T_A = 25^\circ\text{C}$	$I_D$ 7.6	A
		$T_A = 100^\circ\text{C}$	5.4	
Power Dissipation $R_{\theta JA}$ (Notes 1, 3)	Steady State	$T_A = 25^\circ\text{C}$	$P_D$ 3.2	W
		$T_A = 100^\circ\text{C}$	1.6	
Pulsed Drain Current	$T_A = 25^\circ\text{C}, t_p = 10 \mu\text{s}$	$I_{DM}$ 127	A	
Operating Junction and Storage Temperature	$T_J, T_{stg}$	-55 to +175	$^\circ\text{C}$	
Source Current (Body Diode)	$I_S$	18	A	
Single Pulse Drain-to-Source Avalanche Energy ( $T_J = 25^\circ\text{C}, V_{DD} = 24 \text{ V}, V_{GS} = 10 \text{ V}, I_{L(pk)} = 20 \text{ A}, L = 0.1 \text{ mH}, R_G = 25 \Omega$ )	$E_{AS}$	20	mJ	
Lead Temperature for Soldering Purposes (1/8" from case for 10 s)	$T_L$	260	$^\circ\text{C}$	

Stresses exceeding those listed in the Maximum Ratings table may damage the device. If any of these limits are exceeded, device functionality should not be assumed, damage may occur and reliability may be affected.

#### THERMAL RESISTANCE MAXIMUM RATINGS (Note 1)

Parameter	Symbol	Value	Unit
Junction-to-Mounting Board (top) – Steady State (Note 2 and 3)	$R_{\Psi J-mb}$	6.8	$^\circ\text{C}/\text{W}$
Junction-to-Ambient – Steady State (Note 3)	$R_{\theta JA}$	47	

1. The entire application environment impacts the thermal resistance values shown, they are not constants and are only valid for the particular conditions noted.
2. Psi ( $\Psi$ ) is used as required per JESD51-12 for packages in which substantially less than 100% of the heat flows to single case surface.
3. Surface-mounted on FR4 board using a 650 mm<sup>2</sup>, 2 oz. Cu pad.
4. Continuous DC current rating. Maximum current for pulses as long as 1 second is higher but is dependent on pulse duration and duty cycle.

$V_{(BR)DSS}$	$R_{DS(on) MAX}$	$I_D MAX$
60 V	24 mΩ @ 10 V	20 A
	32 mΩ @ 4.5 V	

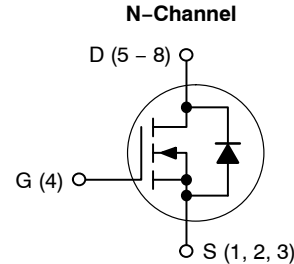

#### MARKING DIAGRAM

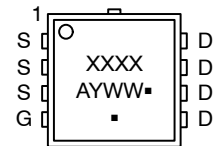

- XXXX = Specific Device Code
- A = Assembly Location
- Y = Year
- WW = Work Week
- = Pb-Free Package

(Note: Microdot may be in either location)

#### ORDERING INFORMATION

See detailed ordering, marking and shipping information in the package dimensions section on page 5 of this data sheet.

# NVTFS5826NL

## ELECTRICAL CHARACTERISTICS (T<sub>J</sub> = 25°C unless otherwise noted)

Parameter	Symbol	Test Condition	Min	Typ	Max	Unit
-----------	--------	----------------	-----	-----	-----	------

### OFF CHARACTERISTICS

Drain-to-Source Breakdown Voltage	V <sub>(BR)DSS</sub>	V <sub>GS</sub> = 0 V, I <sub>D</sub> = 250 μA	60			V
Zero Gate Voltage Drain Current	I <sub>DSS</sub>	V <sub>GS</sub> = 0 V, V <sub>DS</sub> = 60 V	T <sub>J</sub> = 25°C		1.0	μA
			T <sub>J</sub> = 125°C		10	
Gate-to-Source Leakage Current	I <sub>GSS</sub>	V <sub>DS</sub> = 0 V, V <sub>GS</sub> = ±20 V			±100	nA

### ON CHARACTERISTICS (Note 5)

Gate Threshold Voltage	V <sub>GS(TH)</sub>	V <sub>GS</sub> = V <sub>DS</sub> , I <sub>D</sub> = 250 μA	1.5		2.5	V
Drain-to-Source On Resistance	R <sub>DS(on)</sub>	V <sub>GS</sub> = 10 V, I <sub>D</sub> = 10 A		19	24	mΩ
		V <sub>GS</sub> = 4.5 V, I <sub>D</sub> = 10 A		25	32	
Forward Transconductance	g <sub>FS</sub>	V <sub>DS</sub> = 15 V, I <sub>D</sub> = 5 A		8		S

### CHARGES AND CAPACITANCES

Input Capacitance	C <sub>iss</sub>	V <sub>GS</sub> = 0 V, f = 1.0 MHz, V <sub>DS</sub> = 25 V		850		pF
Output Capacitance	C <sub>oss</sub>			85		
Reverse Transfer Capacitance	C <sub>rss</sub>			50		
Total Gate Charge	Q <sub>G(TOT)</sub>	V <sub>GS</sub> = 4.5 V, V <sub>DS</sub> = 48 V, I <sub>D</sub> = 10 A		8.3		nC
Threshold Gate Charge	Q <sub>G(TH)</sub>			1		
Gate-to-Source Charge	Q <sub>GS</sub>			3		
Gate-to-Drain Charge	Q <sub>GD</sub>			4		
Total Gate Charge	Q <sub>G(TOT)</sub>	V <sub>GS</sub> = 10 V, V <sub>DS</sub> = 48 V, I <sub>D</sub> = 10 A		16		nC

### SWITCHING CHARACTERISTICS (Note 6)

Turn-On Delay Time	t <sub>d(on)</sub>	V <sub>GS</sub> = 4.5 V, V <sub>DS</sub> = 48 V, I <sub>D</sub> = 10 A		9		ns
Rise Time	t <sub>r</sub>			29		
Turn-Off Delay Time	t <sub>d(off)</sub>			14		
Fall Time	t <sub>f</sub>			21		

### DRAIN-SOURCE DIODE CHARACTERISTICS

Forward Diode Voltage	V <sub>SD</sub>	V <sub>GS</sub> = 0 V, I <sub>S</sub> = 10 A	T <sub>J</sub> = 25°C		0.8	1.2	V
			T <sub>J</sub> = 125°C		0.7		
Reverse Recovery Time	t <sub>RR</sub>	V <sub>GS</sub> = 0 V, di <sub>S</sub> /dt = 100 A/μs, I <sub>S</sub> = 10 A		18		ns	
Charge Time	t <sub>a</sub>			14			
Discharge Time	t <sub>b</sub>			4			
Reverse Recovery Charge	Q <sub>RR</sub>			17			nC

5. Pulse Test: Pulse Width ≤ 300 μs, Duty Cycle ≤ 2%.

6. Switching characteristics are independent of operating junction temperatures.

TYPICAL CHARACTERISTICS

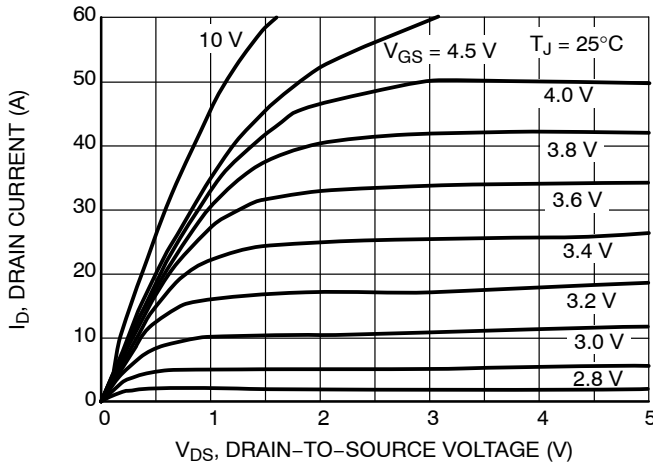

Figure 1. On-Region Characteristics

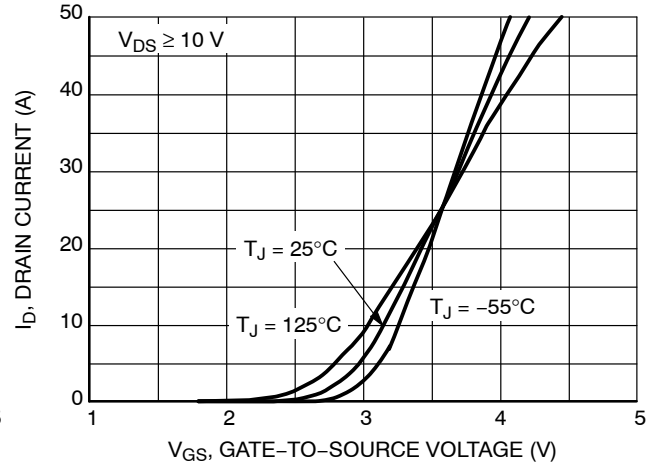

Figure 2. Transfer Characteristics

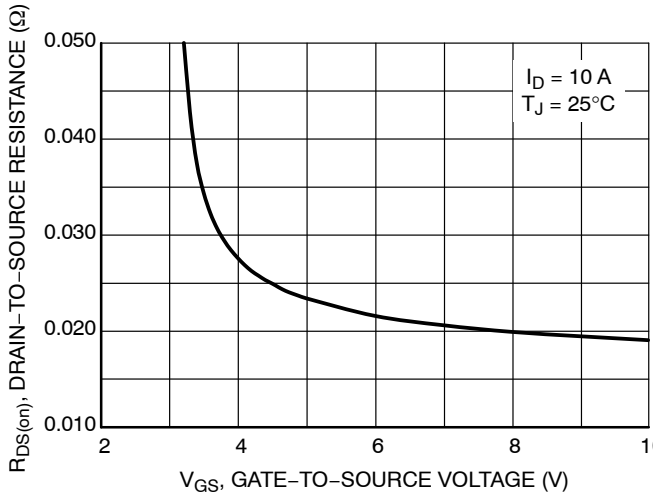

Figure 3. On-Resistance vs. Gate-to-Source Voltage

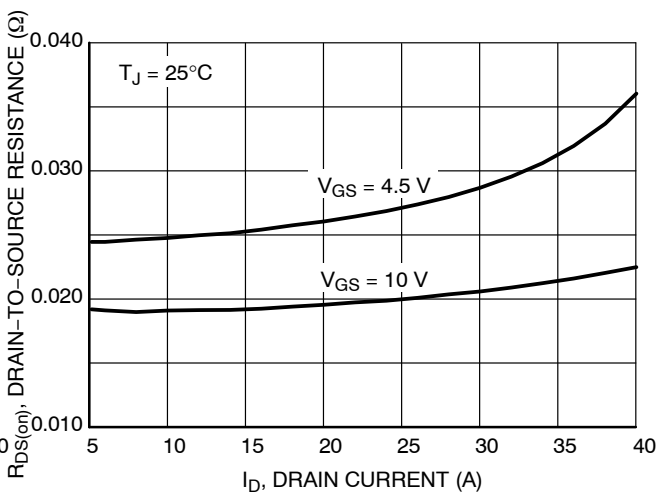

Figure 4. On-Resistance vs. Drain Current and Gate Voltage

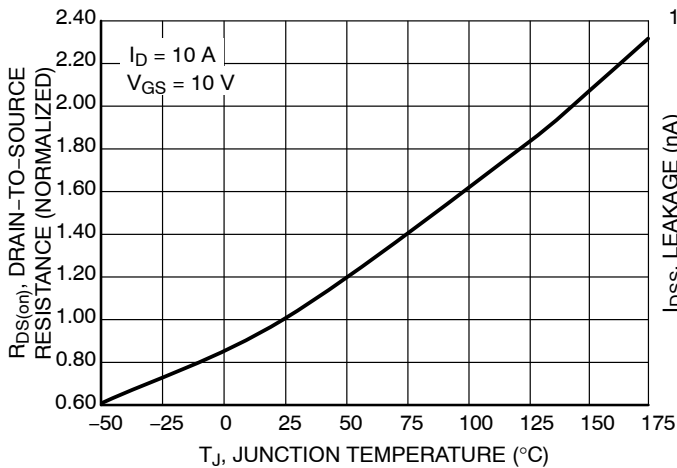

Figure 5. On-Resistance Variation with Temperature

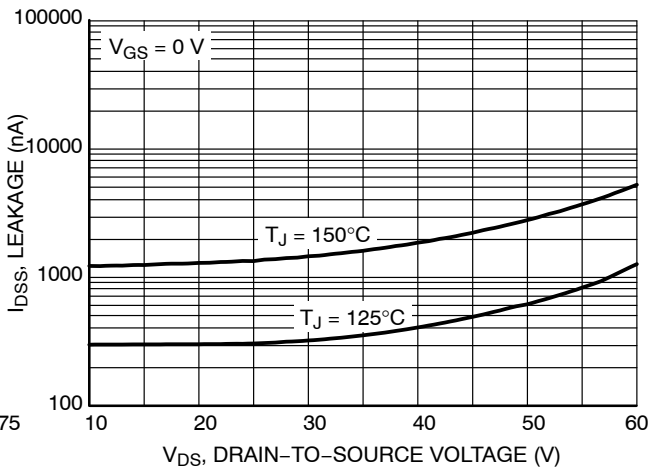

Figure 6. Drain-to-Source Leakage Current vs. Voltage

TYPICAL CHARACTERISTICS

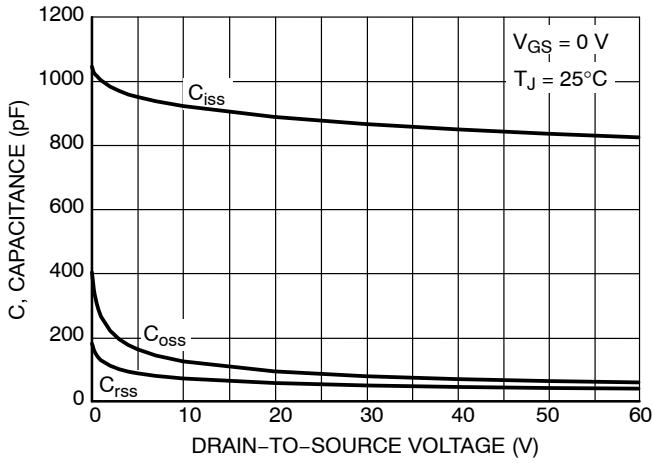

Figure 7. Capacitance Variation

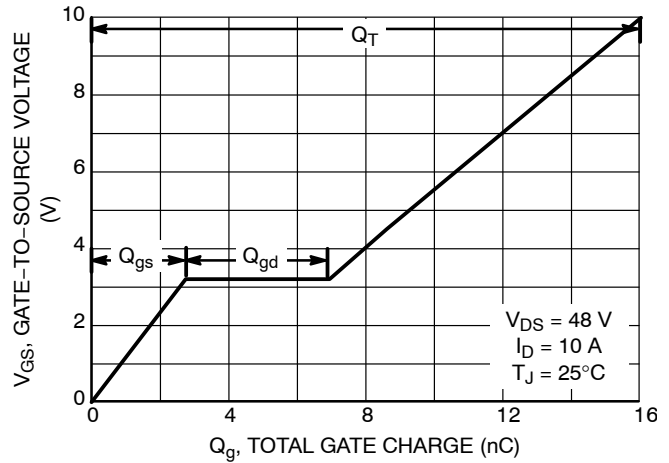

Figure 8. Gate-to-Source Voltage vs. Total Charge

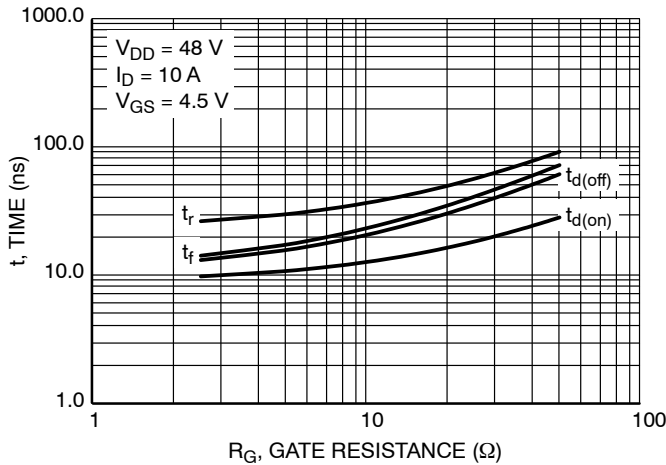

Figure 9. Resistive Switching Time Variation vs. Gate Resistance

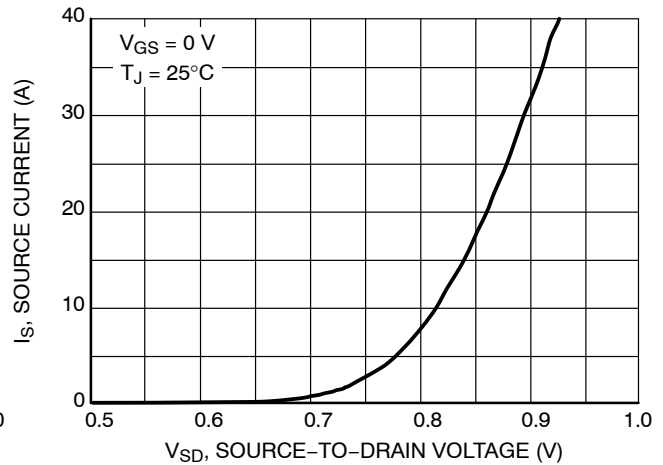

Figure 10. Diode Forward Voltage vs. Current

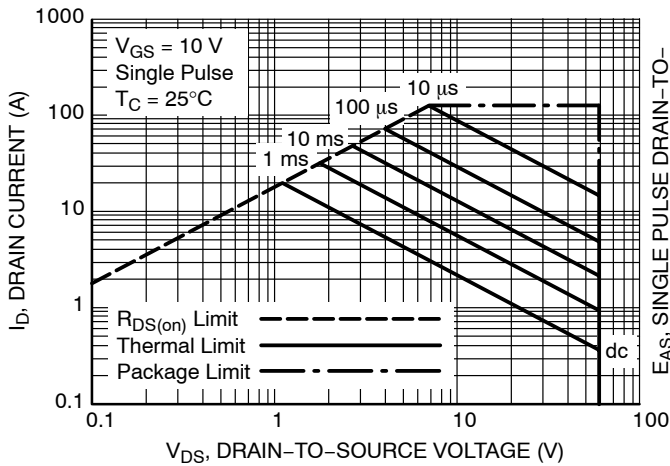

Figure 11. Maximum Rated Forward Biased Safe Operating Area

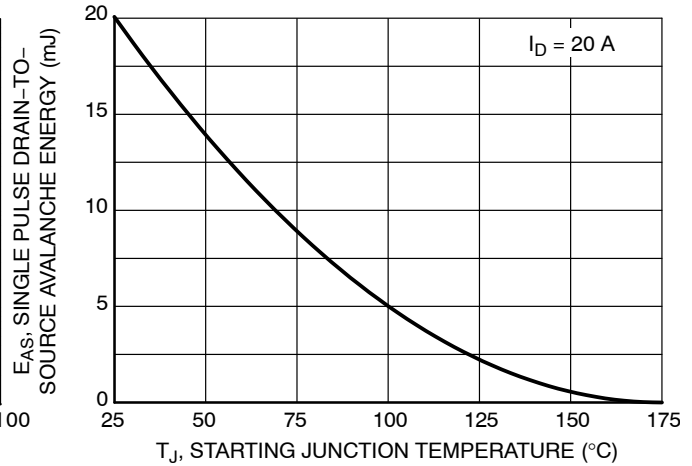
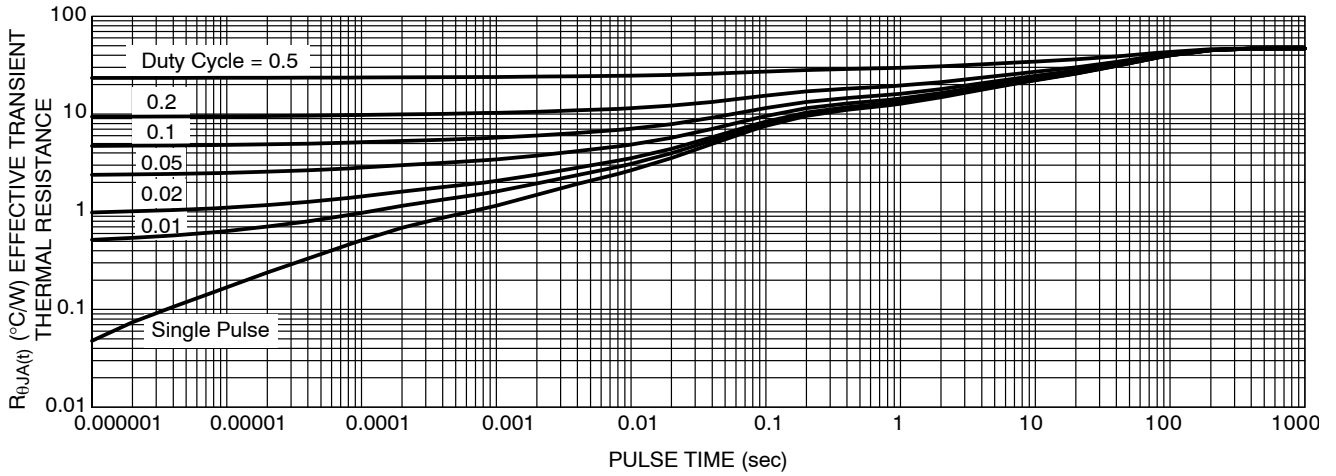

Figure 12. Maximum Avalanche Energy vs. Starting Junction Temperature

# NVTFS5826NL

## TYPICAL CHARACTERISTICS



**Figure 13. Thermal Response**

### DEVICE ORDERING INFORMATION

Device	Marking	Package	Shipping <sup>†</sup>
NVTFS5826NLTAG	5826	WDFN8 (Pb-Free)	1500 / Tape & Reel
NVTFS5826NLWFTAG	26LW	WDFN8 (Pb-Free)	1500 / Tape & Reel
NVTFS5826NLTWG	5826	WDFN8 (Pb-Free)	5000 / Tape & Reel
NVTFS5826NLWFTWG	26LW	WDFN8 (Pb-Free)	5000 / Tape & Reel
NVTFS5826NLWFTWG-UM	26LW	WDFN8 (Pb-Free)	5000 / Tape & Reel

<sup>†</sup>For information on tape and reel specifications, including part orientation and tape sizes, please refer to our Tape and Reel Packaging Specifications Brochure, BRD8011/D.

# MECHANICAL CASE OUTLINE PACKAGE DIMENSIONS



SCALE 2:1

WDFN8 3.3x3.3, 0.65P  
CASE 511AB  
ISSUE D

DATE 23 APR 2012



NOTES:

1. DIMENSIONING AND TOLERANCING PER ASME Y14.5M, 1994.
2. CONTROLLING DIMENSION: MILLIMETERS.
3. DIMENSION D1 AND E1 DO NOT INCLUDE MOLD FLASH PROTRUSIONS OR GATE BURRS.

DIM	MILLIMETERS			INCHES		
	MIN	NOM	MAX	MIN	NOM	MAX
A	0.70	0.75	0.80	0.028	0.030	0.031
A1	0.00	---	0.05	0.000	---	0.002
b	0.23	0.30	0.40	0.009	0.012	0.016
c	0.15	0.20	0.25	0.006	0.008	0.010
D	3.30 BSC			0.130 BSC		
D1	2.95	3.05	3.15	0.116	0.120	0.124
D2	1.98	2.11	2.24	0.078	0.083	0.088
E	3.30 BSC			0.130 BSC		
E1	2.95	3.05	3.15	0.116	0.120	0.124
E2	1.47	1.60	1.73	0.058	0.063	0.068
E3	0.23	0.30	0.40	0.009	0.012	0.016
e	0.65 BSC			0.026 BSC		
G	0.30	0.41	0.51	0.012	0.016	0.020
K	0.65	0.80	0.95	0.026	0.032	0.037
L	0.30	0.43	0.56	0.012	0.017	0.022
L1	0.06	0.13	0.20	0.002	0.005	0.008
M	1.40	1.50	1.60	0.055	0.059	0.063
θ	0°	---	12°	0°	---	12°

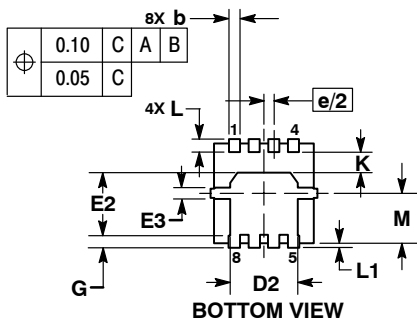

GENERIC MARKING DIAGRAM\*



- XXXXX = Specific Device Code
- A = Assembly Location
- Y = Year
- WW = Work Week
- = Pb-Free Package

\*This information is generic. Please refer to device data sheet for actual part marking. Pb-Free indicator, "G" or microdot "▪", may or may not be present. Some products may not follow the Generic Marking.

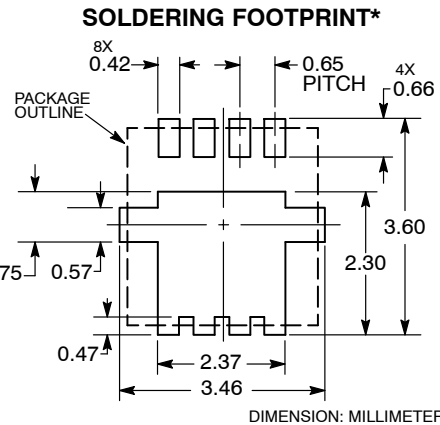

\*For additional information on our Pb-Free strategy and soldering details, please download the ON Semiconductor Soldering and Mounting Techniques Reference Manual, SOLDERRM/D.

DOCUMENT NUMBER:	98AON30561E	Electronic versions are uncontrolled except when accessed directly from the Document Repository. Printed versions are uncontrolled except when stamped "CONTROLLED COPY" in red.
DESCRIPTION:	WDFN8 3.3X3.3, 0.65P	PAGE 1 OF 1

onsemi and ONSEMI are trademarks of Semiconductor Components Industries, LLC dba onsemi or its subsidiaries in the United States and/or other countries. onsemi reserves the right to make changes without further notice to any products herein. onsemi makes no warranty, representation or guarantee regarding the suitability of its products for any particular purpose, nor does onsemi assume any liability arising out of the application or use of any product or circuit, and specifically disclaims any and all liability, including without limitation special, consequential or incidental damages. onsemi does not convey any license under its patent rights nor the rights of others.

**onsemi**, **Onsemi**, and other names, marks, and brands are registered and/or common law trademarks of Semiconductor Components Industries, LLC dba "**onsemi**" or its affiliates and/or subsidiaries in the United States and/or other countries. **onsemi** owns the rights to a number of patents, trademarks, copyrights, trade secrets, and other intellectual property. A listing of **onsemi**'s product/patent coverage may be accessed at [www.onsemi.com/site/pdf/Patent-Marking.pdf](http://www.onsemi.com/site/pdf/Patent-Marking.pdf). **onsemi** reserves the right to make changes at any time to any products or information herein, without notice. The information herein is provided "as-is" and **onsemi** makes no warranty, representation or guarantee regarding the accuracy of the information, product features, availability, functionality, or suitability of its products for any particular purpose, nor does **onsemi** assume any liability arising out of the application or use of any product or circuit, and specifically disclaims any and all liability, including without limitation special, consequential or incidental damages. Buyer is responsible for its products and applications using **onsemi** products, including compliance with all laws, regulations and safety requirements or standards, regardless of any support or applications information provided by **onsemi**. "Typical" parameters which may be provided in **onsemi** data sheets and/or specifications can and do vary in different applications and actual performance may vary over time. All operating parameters, including "Typicals" must be validated for each customer application by customer's technical experts. **onsemi** does not convey any license under any of its intellectual property rights nor the rights of others. **onsemi** products are not designed, intended, or authorized for use as a critical component in life support systems or any FDA Class 3 medical devices or medical devices with a same or similar classification in a foreign jurisdiction or any devices intended for implantation in the human body. Should Buyer purchase or use **onsemi** products for any such unintended or unauthorized application, Buyer shall indemnify and hold **onsemi** and its officers, employees, subsidiaries, affiliates, and distributors harmless against all claims, costs, damages, and expenses, and reasonable attorney fees arising out of, directly or indirectly, any claim of personal injury or death associated with such unintended or unauthorized use, even if such claim alleges that **onsemi** was negligent regarding the design or manufacture of the part. **onsemi** is an Equal Opportunity/Affirmative Action Employer. This literature is subject to all applicable copyright laws and is not for resale in any manner.

## ADDITIONAL INFORMATION

### TECHNICAL PUBLICATIONS:

Technical Library: [www.onsemi.com/design/resources/technical-documentation](http://www.onsemi.com/design/resources/technical-documentation)  
onsemi Website: [www.onsemi.com](http://www.onsemi.com)

### ONLINE SUPPORT: [www.onsemi.com/support](http://www.onsemi.com/support)

For additional information, please contact your local Sales Representative at [www.onsemi.com/support/sales](http://www.onsemi.com/support/sales)