

# Silicon Carbide (SiC) Module – EliteSiC, 6 mohm SiC M1 MOSFET, 1200 V, 2-PACK Half Bridge Topology, F2 Package

## NXH006P120MNF2PTG

The NXH006P120MNF2 is a power module containing an 6 mΩ / 1200 V SiC MOSFET half-bridge and a thermistor in an F2 package.

### Features

- 6 mΩ / 1200 V SiC MOSFET Half-Bridge
- Thermistor
- Options with Pre-Applied Thermal Interface Material (TIM) and without Pre-Applied TIM
- Options with Solderable Pins and Press-Fit Pins
- These Devices are Pb-Free, Halide Free and are RoHS Compliant

### Typical Applications

- Solar Inverter
- Uninterruptible Power Supplies
- Electric Vehicle Charging Stations
- Industrial Power

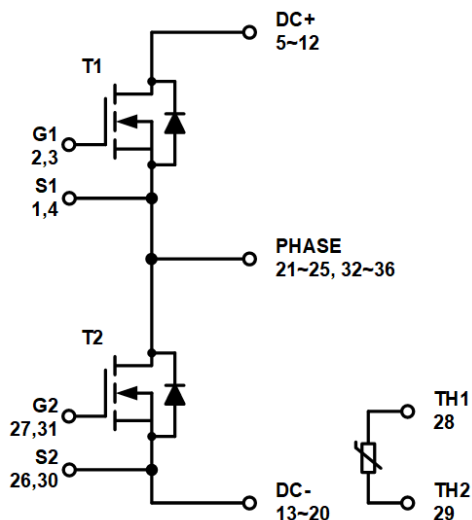
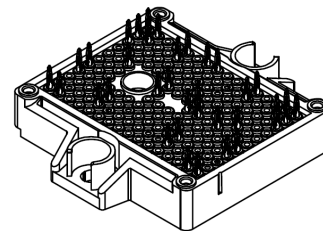

Figure 1. NXH006P120MNF2 Schematic Diagram

### PACKAGE PICTURE



PIM36 56.7x42.5 (PRESS FIT)  
CASE 180BY

### MARKING DIAGRAM

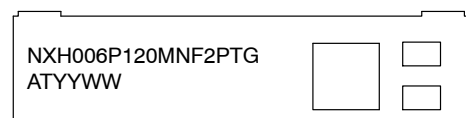

XXXXX = Specific Device Code  
AT = Assembly & Test Site Code  
YWW = Year and Work Week Code

### PIN CONNECTIONS

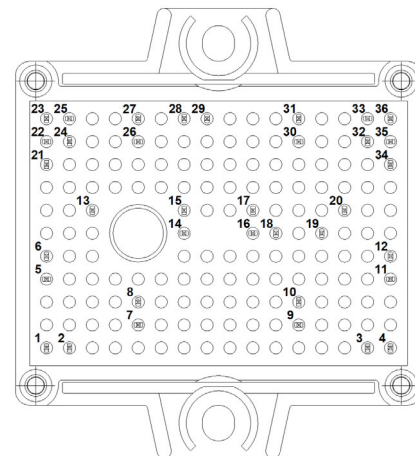

See Pin Function Description for pin names

### ORDERING INFORMATION

See detailed ordering and shipping information on page 4 of this data sheet.

# NXH006P120MNF2PTG

## PIN FUNCTION DESCRIPTION

Pin	Name	Description
1	S1	Q1 Kelvin Emitter (High side switch)
2	G1	Q1 Gate (High side switch)
3	G1	Q1 Gate (High side switch)
4	S1	Q1 Kelvin Emitter (High side switch)
5	DC+	DC Positive Bus connection
6	DC+	DC Positive Bus connection
7	DC+	DC Positive Bus connection
8	DC+	DC Positive Bus connection
9	DC+	DC Positive Bus connection
10	DC+	DC Positive Bus connection
11	DC+	DC Positive Bus connection
12	DC+	DC Positive Bus connection
13	DC-	DC Negative Bus connection
14	DC-	DC Negative Bus connection
15	DC-	DC Negative Bus connection
16	DC-	DC Negative Bus connection
17	DC-	DC Negative Bus connection
18	DC-	DC Negative Bus connection
19	DC-	DC Negative Bus connection
20	DC-	DC Negative Bus connection
21	PHASE	Center point of half bridge
22	PHASE	Center point of half bridge
23	PHASE	Center point of half bridge
24	PHASE	Center point of half bridge
25	PHASE	Center point of half bridge
26	S2	Q2 Kelvin Emitter (Low side switch)
27	G2	Q2 Gate (Low side switch)
28	TH1	Thermistor Connection 1
29	TH2	Thermistor Connection 2
30	S2	Q2 Kelvin Emitter (Low side switch)
31	G2	Q2 Gate (Low side switch)
32	PHASE	Center point of half bridge
33	PHASE	Center point of half bridge
34	PHASE	Center point of half bridge
35	PHASE	Center point of half bridge
36	PHASE	Center point of half bridge

# NXH006P120MNF2PTG

## MAXIMUM RATINGS

Rating	Symbol	Value	Unit
<b>SiC MOSFET</b>			
Drain–Source Voltage	$V_{DSS}$	1200	V
Gate–Source Voltage	$V_{GS}$	+25/–15	V
Continuous Drain Current @ $T_c = 80^\circ\text{C}$ ( $T_J = 175^\circ\text{C}$ )	$I_D$	304	A
Pulsed Drain Current ( $T_J = 175^\circ\text{C}$ ) (Note 2)	$I_{Dpulse}$	912	A
Maximum Power Dissipation ( $T_J = 175^\circ\text{C}$ )	$P_{tot}$	950	W
Short Circuit Withstand Time @ $V_{GE} = 15\text{ V}$ , $V_{CE} = 600\text{ V}$ , $T_J \leq 150^\circ\text{C}$	$T_{sc}$	2.0	$\mu\text{s}$
Minimum Operating Junction Temperature	$T_{JMIN}$	–40	$^\circ\text{C}$
Maximum Operating Junction Temperature	$T_{JMAX}$	175	$^\circ\text{C}$

## THERMAL PROPERTIES

Storage Temperature Range	$T_{stg}$	–40 to 150	$^\circ\text{C}$
TIM Layer Thickness	$T_{TIM}$	$160 \pm 20$	$\mu\text{m}$

## INSULATION PROPERTIES

Isolation test voltage, $t = 1\text{ sec}$ , 60 Hz	$V_{is}$	4800	$V_{RMS}$
Creepage distance		12.7	mm
CTI		600	
Substrate Ceramic Material		HPS	
Substrate Ceramic Material Thickness		0.38	mm
Substrate Warpage (Note 3)	W	Max 0.18	mm

Stresses exceeding those listed in the Maximum Ratings table may damage the device. If any of these limits are exceeded, device functionality should not be assumed, damage may occur and reliability may be affected.

1. Refer to ELECTRICAL CHARACTERISTICS, RECOMMENDED OPERATING RANGES and/or APPLICATION INFORMATION for Safe Operating parameters.
2. Calculated for 1 ms pulse, package limitation at 400 A.
3. Height difference between horizontal plane and substrate bottom copper.

## RECOMMENDED OPERATING RANGES

Rating	Symbol	Min	Max	Unit
Module Operating Junction Temperature	$T_J$	–40	175	$^\circ\text{C}$

Functional operation above the stresses listed in the Recommended Operating Ranges is not implied. Extended exposure to stresses beyond the Recommended Operating Ranges limits may affect device reliability.

## ELECTRICAL CHARACTERISTICS

$T_J = 25^\circ\text{C}$  unless otherwise noted

Parameter	Test Conditions	Symbol	Min	Typ	Max	Unit
<b>SiC MOSFET CHARACTERISTICS</b>						
Drain–Source Breakdown Voltage	$V_{GS} = 0\text{ V}$ , $I_D = 800\ \mu\text{A}$	$V_{(BR)DSS}$	1200	–	–	V
Zero Gate Voltage Drain Current	$V_{GS} = 0\text{ V}$ , $V_{DS} = 1200\text{ V}$	$I_{DSS}$	–	–	300	$\mu\text{A}$
Drain–Source On Resistance	$V_{GS} = 20\text{ V}$ , $I_D = 200\text{ A}$ , $T_J = 25^\circ\text{C}$	$R_{DS(ON)}$	–	5.48	7.2	m $\Omega$
	$V_{GS} = 20\text{ V}$ , $I_D = 200\text{ A}$ , $T_J = 125^\circ\text{C}$		–	6.52	–	
	$V_{GS} = 20\text{ V}$ , $I_D = 200\text{ A}$ , $T_J = 150^\circ\text{C}$		–	7.28	–	
Gate–Source Threshold Voltage	$V_{GS} = V_{DS}$ , $I_D = 80\text{ mA}$	$V_{GS(TH)}$	1.8	2.83	4.3	V
Gate Leakage Current	$V_{GS} = -10\text{ V} / 20\text{ V}$ , $V_{DS} = 0\text{ V}$	$I_{GSS}$	–1000	–	1000	nA

# NXH006P120MNF2PTG

## ELECTRICAL CHARACTERISTICS (continued)

T<sub>J</sub> = 25 °C unless otherwise noted

Parameter	Test Conditions	Symbol	Min	Typ	Max	Unit	
<b>SiC MOSFET CHARACTERISTICS</b>							
Input Capacitance	V <sub>DS</sub> = 800 V, V <sub>GS</sub> = 0 V, f = 1 MHz	C <sub>ISS</sub>	–	6687	–	pF	
Reverse Transfer Capacitance		C <sub>RSS</sub>	–	49	–		
Output Capacitance		C <sub>OSS</sub>	–	1092	–		
Total Gate Charge	V <sub>DS</sub> = 800 V, V <sub>GS</sub> = 20 V, I <sub>D</sub> = 200 A	Q <sub>G(TOTAL)</sub>	–	847	–	nC	
Gate–Source Charge		Q <sub>GS</sub>	–	231	–		
Gate–Drain Charge		Q <sub>GD</sub>	–	195	–		
Turn-on Delay Time	T <sub>J</sub> = 25°C V <sub>DS</sub> = 600 V, I <sub>D</sub> = 200 A V <sub>GS</sub> = -5 V / 20 V, R <sub>G</sub> = 1.8 Ω	t <sub>d(on)</sub>	–	54	–	ns	
Rise Time		t <sub>r</sub>	–	21	–		
Turn-off Delay Time		t <sub>d(off)</sub>	–	174	–		
Fall Time		t <sub>f</sub>	–	22	–		
Turn-on Switching Loss per Pulse		E <sub>ON</sub>	–	2.1	–		mJ
Turn-off Switching Loss per Pulse		E <sub>OFF</sub>	–	2.75	–		
Turn-on Delay Time	T <sub>J</sub> = 150°C V <sub>DS</sub> = 600 V, I <sub>D</sub> = 200 A V <sub>GS</sub> = -5 V / 20 V, R <sub>G</sub> = 1.8 Ω	t <sub>d(on)</sub>	–	48	–	ns	
Rise Time		t <sub>r</sub>	–	19	–		
Turn-off Delay Time		t <sub>d(off)</sub>	–	196	–		
Fall Time		t <sub>f</sub>	–	22	–		
Turn-on Switching Loss per Pulse		E <sub>ON</sub>	–	2.3	–		mJ
Turn off Switching Loss per Pulse		E <sub>OFF</sub>	–	2.93	–		
Diode Forward Voltage	I <sub>D</sub> = 200 A, T <sub>J</sub> = 25°C	V <sub>SD</sub>	–	4.0	6	V	
	I <sub>D</sub> = 200 A, T <sub>J</sub> = 150°C		–	3.6	–		
Thermal Resistance – Chip-to-Case	M1, M2	R <sub>thJC</sub>	–	0.10	–	°C/W	
Thermal Resistance – Chip-to-Heatsink	Thermal grease, Thickness = 2 Mil +2%, A = 2.8 W/mK	R <sub>thJH</sub>	–	0.21	–	°C/W	

## Thermistor Characteristics

Nominal Resistance	T = 25°C	R <sub>25</sub>	–	5	–	kΩ
	T = 100°C	R <sub>100</sub>	–	457	–	Ω
Deviation of R25		ΔR/R	-3	–	3	%
Power Dissipation		P <sub>D</sub>	–	50	–	mW
Power Dissipation Constant			–	5	–	mW/K
B-value	B(25/50), tolerance ±3%		–	3375	–	K
B-value	B(25/100), tolerance ±3%		–	3455	–	K

Product parametric performance is indicated in the Electrical Characteristics for the listed test conditions, unless otherwise noted. Product performance may not be indicated by the Electrical Characteristics if operated under different conditions.

## ORDERING INFORMATION

Orderable Part Number	Marking	Package	Shipping
NXH006P120MNF2PTG	NXH006P120MNF2PTG	F2HALFBR: Case 180BY Press-fit Pins with pre-applied thermal interface material (TIM) (Pb-Free / Halide Free)	20 Units / Blister Tray

# NXH006P120MNF2PTG

## TYPICAL CHARACTERISTICS HALFBRIDGE MOSFET

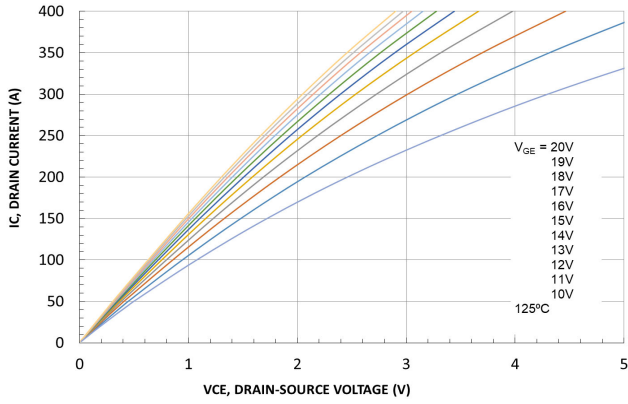

Figure 2. MOSFET Typical Output Characteristic at 125°C

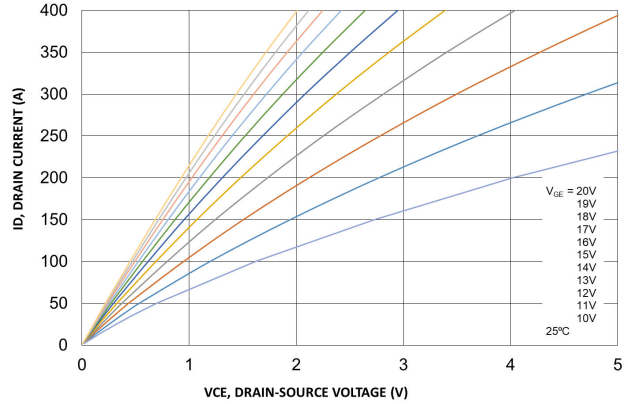

Figure 3. MOSFET Typical Output Characteristic at 25°C

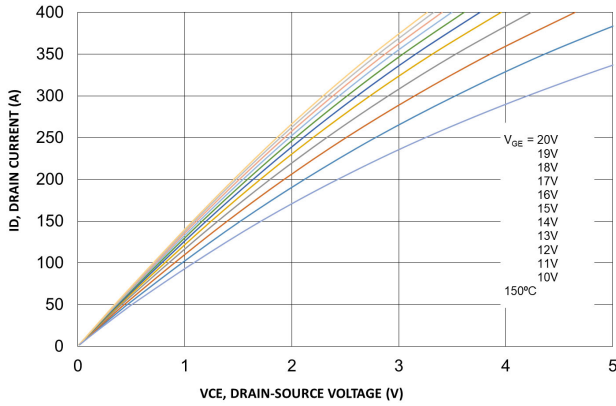

Figure 4. MOSFET Typical Output Characteristic at 150°C

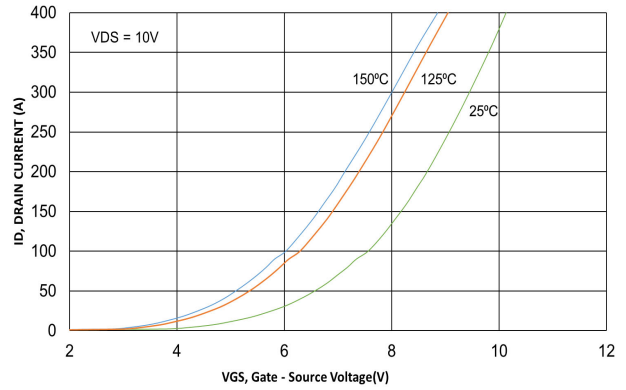

Figure 5. MOSFET Typical Transfer Characteristic

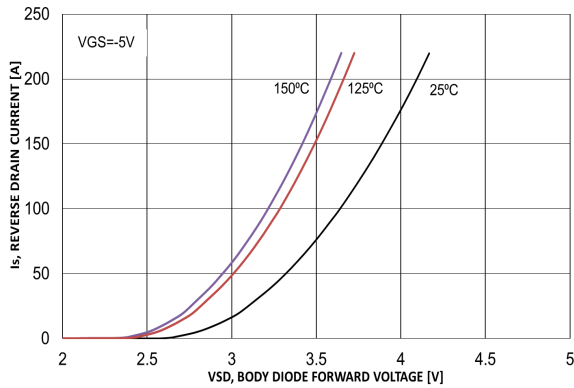

Figure 6. Body Diode Forward Characteristic

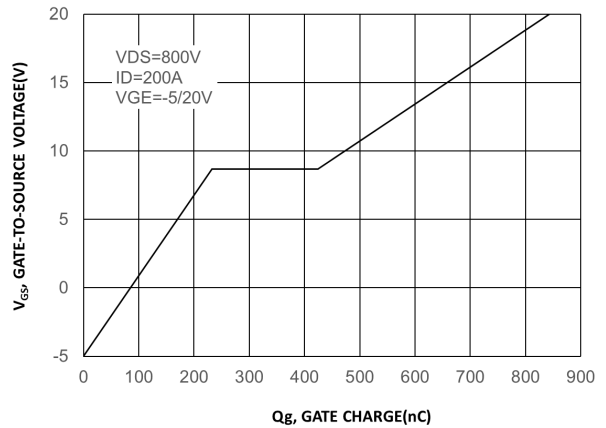

Figure 7. Gate-to-Source Voltage vs. Total Charge

# NXH006P120MNF2PTG

## TYPICAL CHARACTERISTICS

(25°C unless otherwise noted)

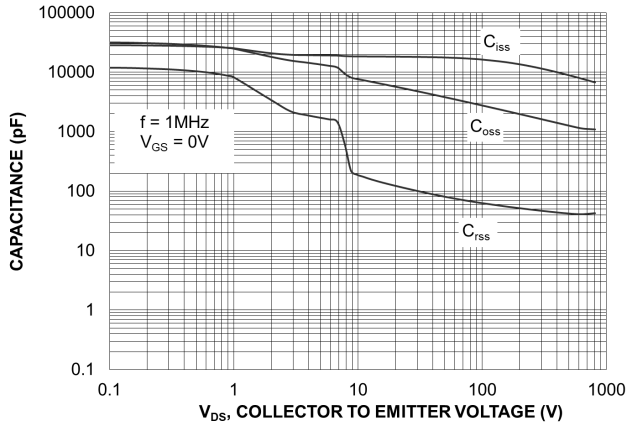

Figure 8. Capacitance vs. Drain-to-Source Voltage

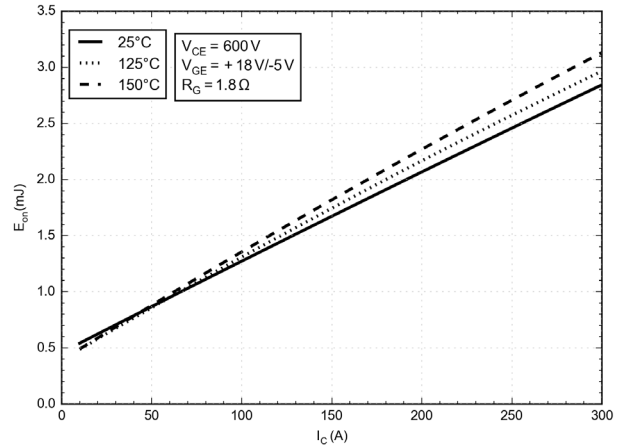

Figure 9. Typical Switching Loss E<sub>on</sub> vs. I<sub>C</sub>

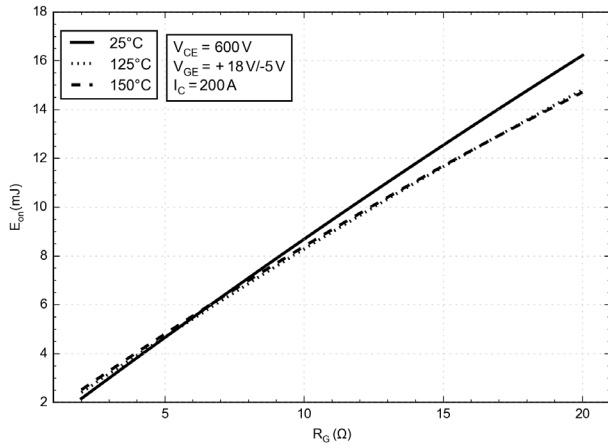

Figure 10. Typical Switching Loss E<sub>on</sub> vs. R<sub>G</sub>

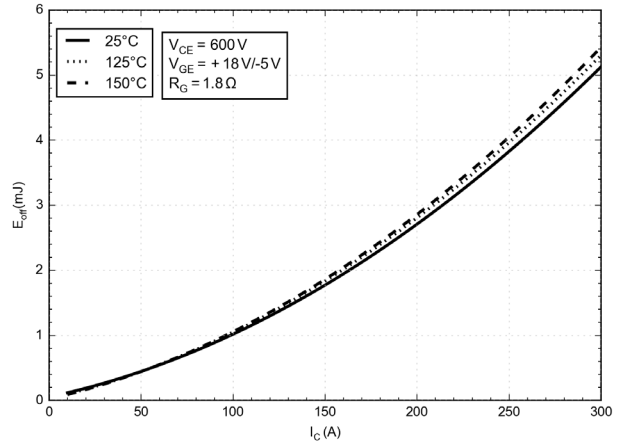

Figure 11. Typical Switching Loss E<sub>off</sub> vs. I<sub>C</sub>

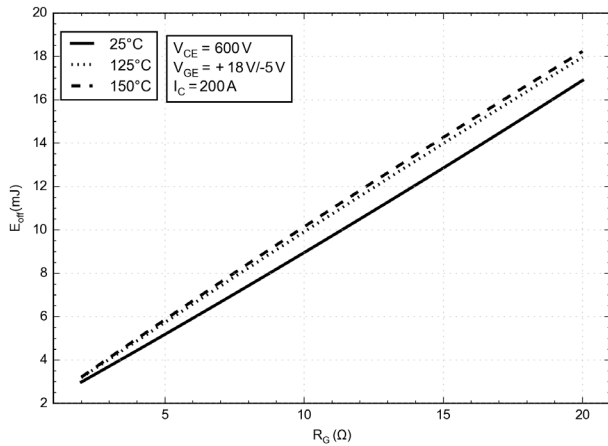

Figure 12. Typical Switching Loss E<sub>off</sub> vs. R<sub>G</sub>

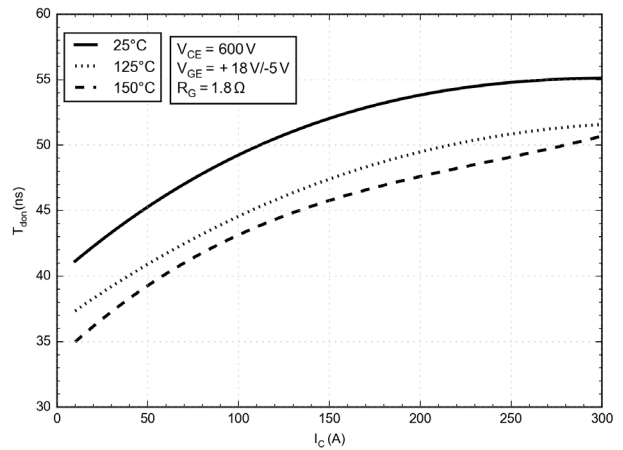

Figure 13. Typical Switching Loss T<sub>don</sub> vs. I<sub>C</sub>

# NXH006P120MNF2PTG

## TYPICAL CHARACTERISTICS

(25°C unless otherwise noted)

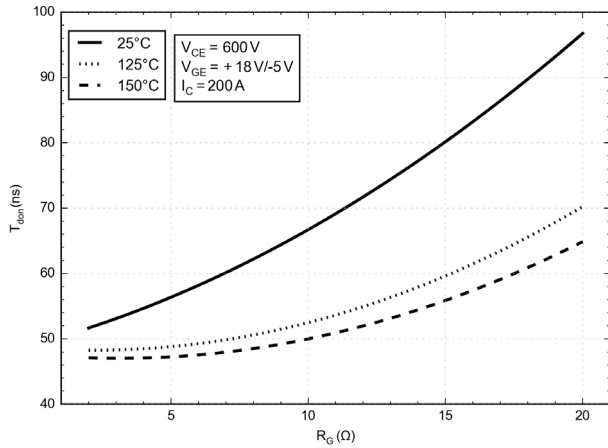

Figure 14. Typical Switching Loss  $T_{don}$  vs.  $R_g$

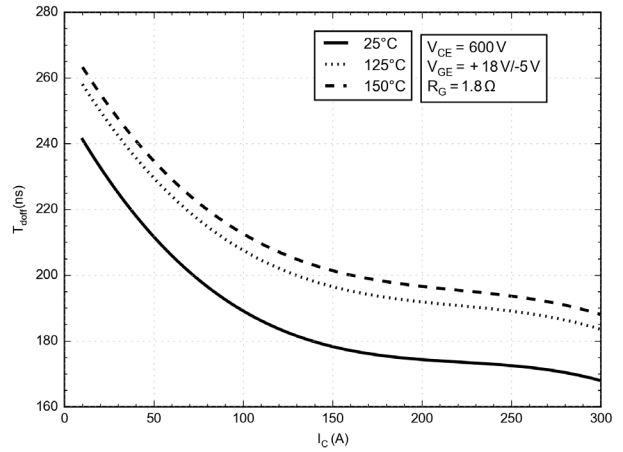

Figure 15. Typical Switching Loss  $T_{doff}$  vs.  $I_C$

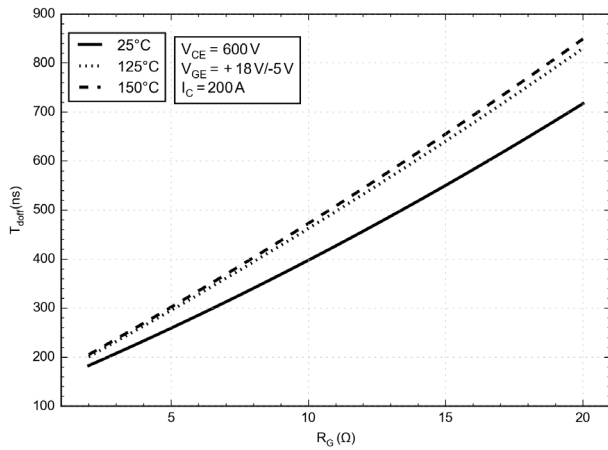

Figure 16. Typical Switching Loss  $T_{doff}$  vs.  $R_g$

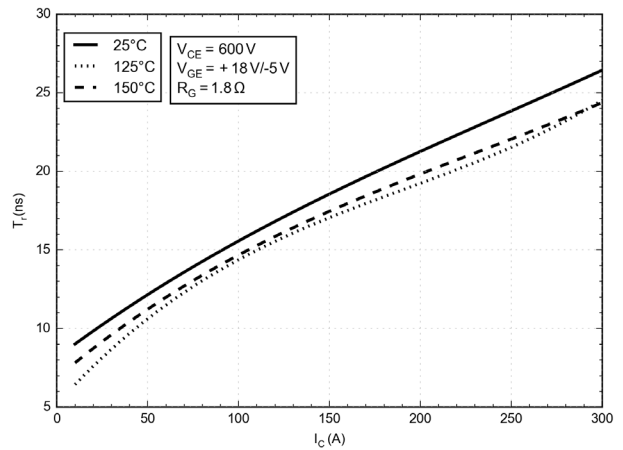

Figure 17. Typical Switching Loss  $T_r$  vs.  $I_C$

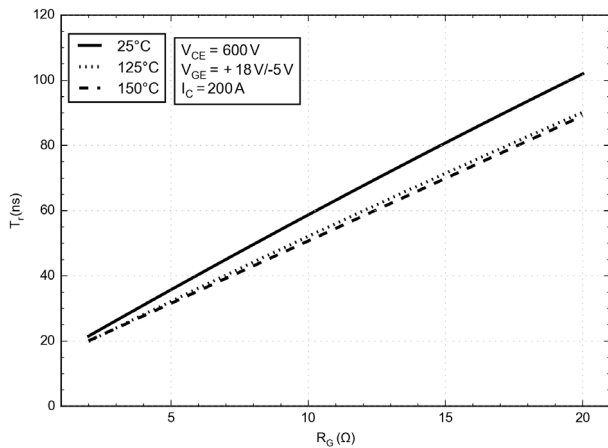

Figure 18. Typical Switching Loss  $T_r$  vs.  $R_g$

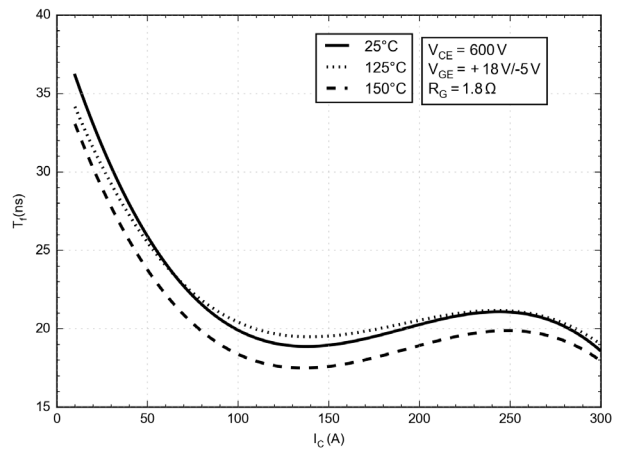

Figure 19. Typical Switching Loss  $T_f$  vs.  $I_C$

# NXH006P120MNF2PTG

## TYPICAL CHARACTERISTICS

(25°C unless otherwise noted)

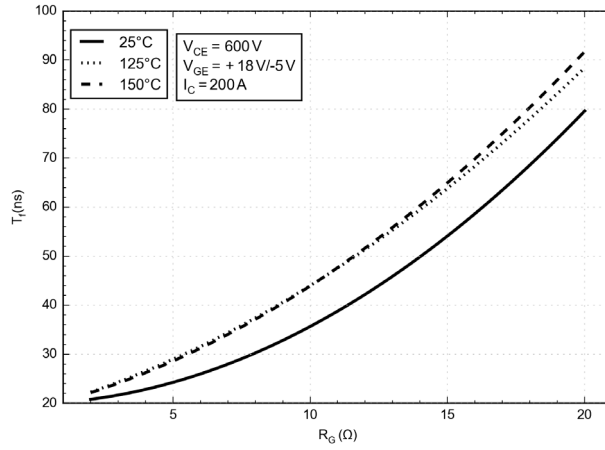

Figure 20. Typical Switching Loss  $T_f$  vs.  $R_g$

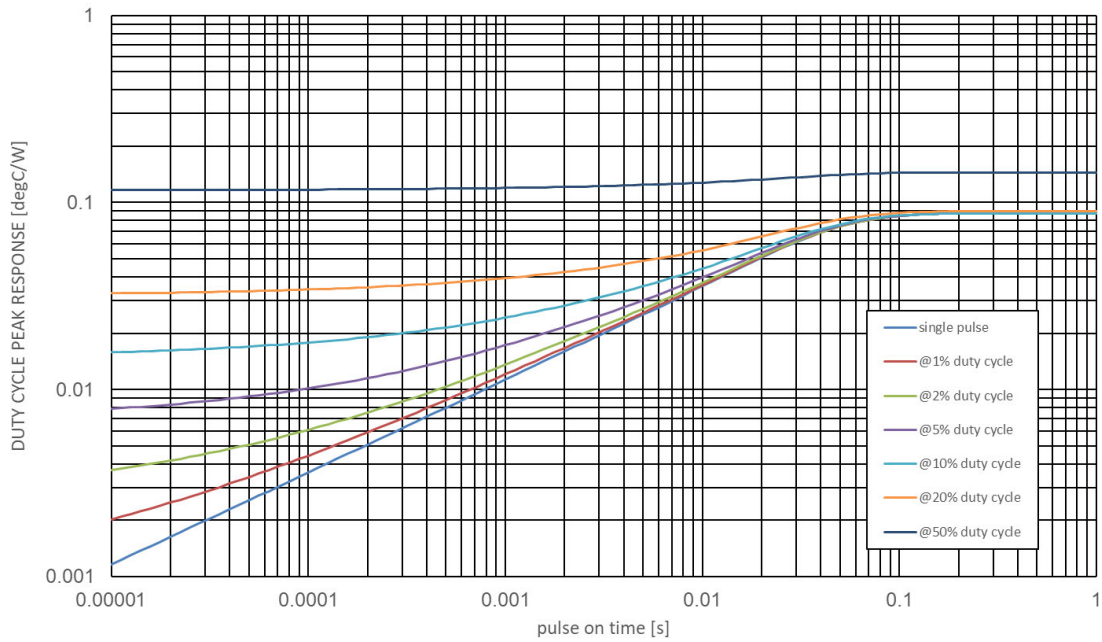
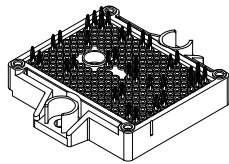

Figure 21. MOSFET Junction-to-Case Transient Thermal Impedance





**PIM36 56.70x42.50x12.00**  
**CASE 180BY**  
**ISSUE E**

DATE 20 DEC 2023

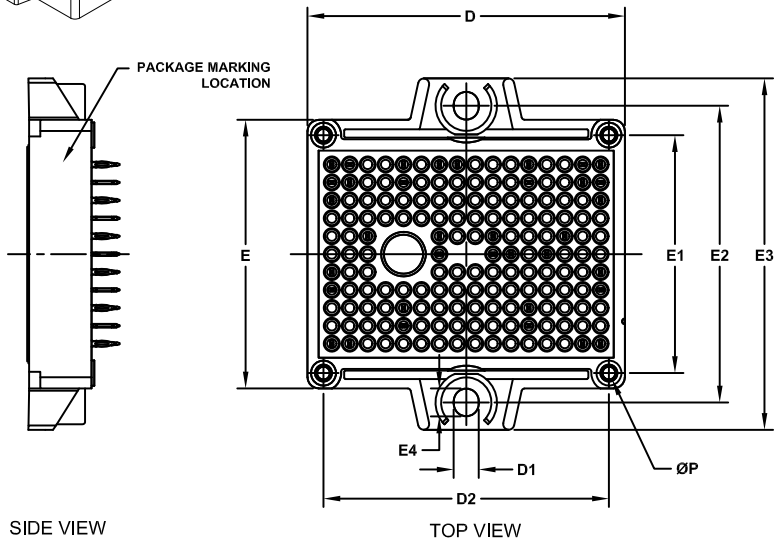

**NOTES:**

1. CONTROLLING DIMENSION: MILLIMETERS
2. PIN POSITION TOLERANCE IS  $\pm 0.4\text{mm}$
3. PRESS FIT PIN

DIM	MILLIMETERS		
	MIN.	NOM.	MAX.
A	11.65	12.00	12.35
A1	16.10	16.50	16.90
A2	0.00	0.35	0.60
A3	12.95	13.35	13.75
b	1.15	1.20	1.25
b1	0.59	0.64	0.69
D	56.40	56.70	57.00
D1	4.40	4.50	4.60
D2	50.85	51.00	51.15
E	47.70	48.00	48.30
E1	42.35	42.50	42.65
E2	52.90	53.00	53.10
E3	62.30	62.80	63.30
E4	4.90	5.00	5.10
P	2.20	2.30	2.40

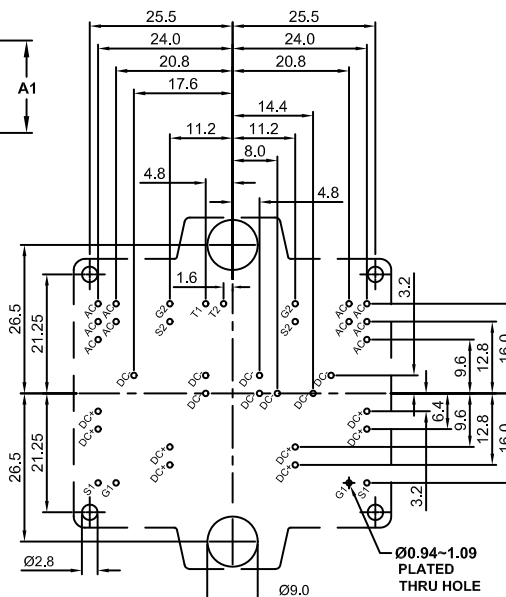
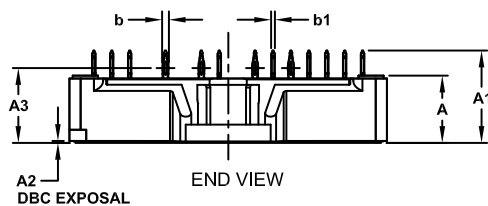

**GENERIC MARKING DIAGRAM\***

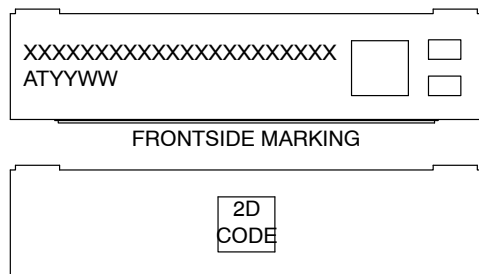

XXXXX = Specific Device Code  
AT = Assembly & Test Site Code  
YYWW = Year and Work Week Code

\*This information is generic. Please refer to device data sheet for actual part marking. Pb-Free indicator, "G" or microdot "▪", may or may not be present. Some products may not follow the Generic Marking.

<b>DOCUMENT NUMBER:</b>	<b>98AON19725H</b>	Electronic versions are uncontrolled except when accessed directly from the Document Repository. Printed versions are uncontrolled except when stamped "CONTROLLED COPY" in red.
<b>DESCRIPTION:</b>	<b>PIM36 56.70x42.50x12.00</b>	<b>PAGE 1 OF 1</b>

onsemi and onsemi are trademarks of Semiconductor Components Industries, LLC dba onsemi or its subsidiaries in the United States and/or other countries. onsemi reserves the right to make changes without further notice to any products herein. onsemi makes no warranty, representation or guarantee regarding the suitability of its products for any particular purpose, nor does onsemi assume any liability arising out of the application or use of any product or circuit, and specifically disclaims any and all liability, including without limitation special, consequential or incidental damages. onsemi does not convey any license under its patent rights nor the rights of others.

**onsemi**, **Onsemi**, and other names, marks, and brands are registered and/or common law trademarks of Semiconductor Components Industries, LLC dba "**onsemi**" or its affiliates and/or subsidiaries in the United States and/or other countries. **onsemi** owns the rights to a number of patents, trademarks, copyrights, trade secrets, and other intellectual property. A listing of **onsemi**'s product/patent coverage may be accessed at [www.onsemi.com/site/pdf/Patent-Marking.pdf](http://www.onsemi.com/site/pdf/Patent-Marking.pdf). **onsemi** reserves the right to make changes at any time to any products or information herein, without notice. The information herein is provided "as-is" and **onsemi** makes no warranty, representation or guarantee regarding the accuracy of the information, product features, availability, functionality, or suitability of its products for any particular purpose, nor does **onsemi** assume any liability arising out of the application or use of any product or circuit, and specifically disclaims any and all liability, including without limitation special, consequential or incidental damages. Buyer is responsible for its products and applications using **onsemi** products, including compliance with all laws, regulations and safety requirements or standards, regardless of any support or applications information provided by **onsemi**. "Typical" parameters which may be provided in **onsemi** data sheets and/or specifications can and do vary in different applications and actual performance may vary over time. All operating parameters, including "Typicals" must be validated for each customer application by customer's technical experts. **onsemi** does not convey any license under any of its intellectual property rights nor the rights of others. **onsemi** products are not designed, intended, or authorized for use as a critical component in life support systems or any FDA Class 3 medical devices or medical devices with a same or similar classification in a foreign jurisdiction or any devices intended for implantation in the human body. Should Buyer purchase or use **onsemi** products for any such unintended or unauthorized application, Buyer shall indemnify and hold **onsemi** and its officers, employees, subsidiaries, affiliates, and distributors harmless against all claims, costs, damages, and expenses, and reasonable attorney fees arising out of, directly or indirectly, any claim of personal injury or death associated with such unintended or unauthorized use, even if such claim alleges that **onsemi** was negligent regarding the design or manufacture of the part. **onsemi** is an Equal Opportunity/Affirmative Action Employer. This literature is subject to all applicable copyright laws and is not for resale in any manner.

## ADDITIONAL INFORMATION

### TECHNICAL PUBLICATIONS:

Technical Library: [www.onsemi.com/design/resources/technical-documentation](http://www.onsemi.com/design/resources/technical-documentation)  
onsemi Website: [www.onsemi.com](http://www.onsemi.com)

### ONLINE SUPPORT: [www.onsemi.com/support](http://www.onsemi.com/support)

For additional information, please contact your local Sales Representative at [www.onsemi.com/support/sales](http://www.onsemi.com/support/sales)