

Silicon Carbide (SiC) Module – EliteSiC, 7 mohm, 1200 V, SiC M3S MOSFET, Full Bridge, F2 Package

Product Preview

NXH007F120M3F2PTHG

The NXH007F120M3F2PTHG is a power module containing 7 mΩ / 1200 V SiC MOSFET full-bridge and a thermistor with HPS DBC in an F2 package.

Features

- 7 mΩ / 1200 V M3S SiC MOSFET Full-Bridge
- HPS DBC
- Thermistor
- Options with Pre-Applied Thermal Interface Material (TIM) and without Pre-Applied TIM
- Press-Fit Pins
- These Devices are Pb-Free, Halide Free and are RoHS Compliant

Typical Applications

- Solar Inverter
- Uninterruptible Power Supplies
- Electric Vehicle Charging Stations
- Industrial Power

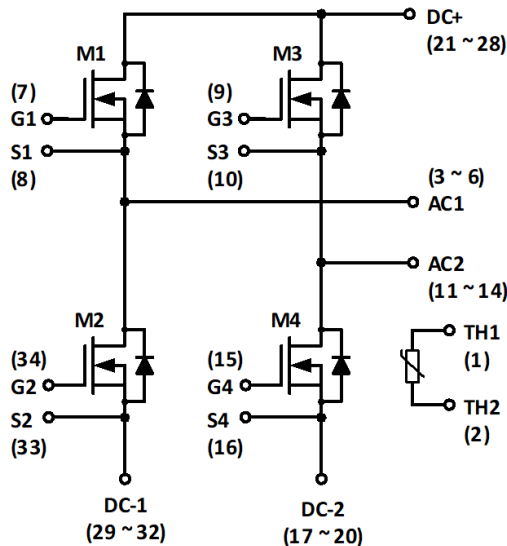
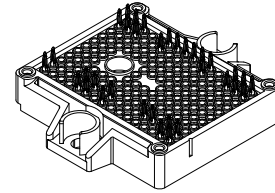

Figure 1. NXH007F120M3F2PTHG Schematic Diagram

This document contains information on a product under development. onsemi reserves the right to change or discontinue this product without notice.



PIM34 56.7x42.5 (PRESS FIT)
CASE 180HU

MARKING DIAGRAM

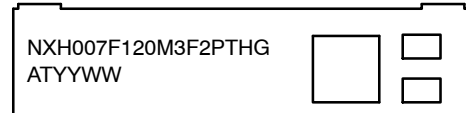

NXH007F120M3F2PTHG = Specific Device Code
AT = Assembly & Test Site Code
YYWW = Year and Work Week Code

PIN CONNECTIONS

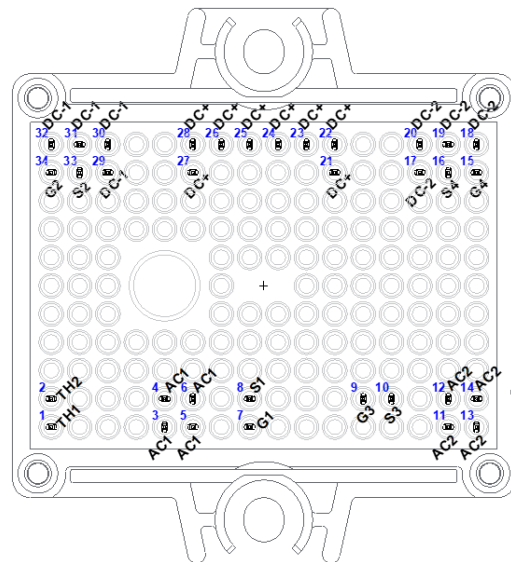

See Pin Function Description for pin names

ORDERING INFORMATION

See detailed ordering and shipping information on page 4 of this data sheet.

NXH007F120M3F2PTHG

PIN FUNCTION DESCRIPTION

Pin	Name	Description
1	TH1	Thermistor Connection 1
2	TH2	Thermistor Connection 2
3	AC1	Center point of full bridge 1
4	AC1	Center point of full bridge 1
5	AC1	Center point of full bridge 1
6	AC1	Center point of full bridge 1
7	G1	M1 Gate (High side switch)
8	S1	M1 Kelvin Emitter (High side switch)
9	G3	M3 Gate (High side switch)
10	S3	M3 Kelvin Emitter (High side switch)
11	AC2	Center point of full bridge 2
12	AC2	Center point of full bridge 2
13	AC2	Center point of full bridge 2
14	AC2	Center point of full bridge 2
15	G4	M4 Gate (Low side switch)
16	S4	M4 Kelvin Emitter (Low side switch)
17	DC-2	DC Negative Bus connection
18	DC-2	DC Negative Bus connection
19	DC-2	DC Negative Bus connection
20	DC-2	DC Negative Bus connection
21	DC+	DC Positive Bus connection
22	DC+	DC Positive Bus connection
23	DC+	DC Positive Bus connection
24	DC+	DC Positive Bus connection
25	DC+	DC Positive Bus connection
26	DC+	DC Positive Bus connection
27	DC+	DC Positive Bus connection
28	DC+	DC Positive Bus connection
29	DC-1	DC Negative Bus connection
30	DC-1	DC Negative Bus connection
31	DC-1	DC Negative Bus connection
32	DC-1	DC Negative Bus connection
33	S2	M2 Kelvin Emitter (Low side switch)
34	G2	M2 Gate (Low side switch)

NXH007F120M3F2PTHG

MAXIMUM RATINGS

Rating	Symbol	Value	Unit
SiC MOSFET			
Drain–Source Voltage	V_{DSS}	1200	V
Gate–Source Voltage	V_{GS}	+22/-10	V
Continuous Drain Current @ $T_c = 80^\circ\text{C}$ ($T_J = 175^\circ\text{C}$)	I_D	149	A
Pulsed Drain Current ($T_J = 175^\circ\text{C}$) (Note 2)	I_{Dpulse}	447	A
Maximum Power Dissipation ($T_J = 175^\circ\text{C}$)	P_{tot}	353	W
Minimum Operating Junction Temperature	T_{JMIN}	-40	$^\circ\text{C}$
Maximum Operating Junction Temperature	T_{JMAX}	175	$^\circ\text{C}$

THERMAL PROPERTIES

Storage Temperature Range	T_{stg}	-40 to 150	$^\circ\text{C}$
---------------------------	-----------	------------	------------------

INSULATION PROPERTIES

Isolation Test Voltage, $t = 1$ s, 60 Hz	V_{is}	4800	V_{RMS}
Creepage Distance		12.7	mm
CTI		600	
Substrate Ceramic Material		HPS	
Substrate Ceramic Material Thickness		0.38	mm

Stresses exceeding those listed in the Maximum Ratings table may damage the device. If any of these limits are exceeded, device functionality should not be assumed, damage may occur and reliability may be affected.

1. Refer to ELECTRICAL CHARACTERISTICS, RECOMMENDED OPERATING RANGES and/or APPLICATION INFORMATION for Safe Operating parameters.
2. Height difference between horizontal plane and substrate copper bottom.

RECOMMENDED OPERATING RANGES

Rating	Symbol	Min	Max	Unit
Module Operating Junction Temperature	T_J	-40	150	$^\circ\text{C}$

Functional operation above the stresses listed in the Recommended Operating Ranges is not implied. Extended exposure to stresses beyond the Recommended Operating Ranges limits may affect device reliability.

ELECTRICAL CHARACTERISTICS ($T_J = 25^\circ\text{C}$ unless otherwise noted)

Parameter	Test Conditions	Symbol	Min	Typ	Max	Unit
SiC MOSFET CHARACTERISTICS						
Zero Gate Voltage Drain Current	$V_{GS} = 0$ V, $V_{DS} = 1200$ V, $T_J = 25^\circ\text{C}$	I_{DSS}	–	–	300	μA
Drain–Source On Resistance	$V_{GS} = 18$ V, $I_D = 120$ A, $T_J = 25^\circ\text{C}$	$R_{DS(ON)}$	–	7.5	10	m Ω
	$V_{GS} = 18$ V, $I_D = 120$ A, $T_J = 125^\circ\text{C}$		–	12.1	–	
	$V_{GS} = 18$ V, $I_D = 120$ A, $T_J = 150^\circ\text{C}$		–	13.6	–	
	$V_{GS} = 18$ V, $I_D = 120$ A, $T_J = 175^\circ\text{C}$		–	15.9	–	
Gate–Source Threshold Voltage	$V_{GS} = V_{DS}$, $I_D = 60$ mA	$V_{GS(TH)}$	2.04	2.72	4.4	V
Recommended Gate Voltage		V_{GOP}	-3	–	+18	V
Gate Leakage Current	$V_{GS} = -10$ V / 22 V, $V_{DS} = 0$ V	I_{GSS}	–	–	± 3	μA
Input Capacitance	$V_{GS} = 0$ V, $f = 1$ MHz, $V_{DS} = 800$ V	C_{ISS}	–	9090	–	pF
Reverse Transfer Capacitance		C_{RSS}	–	37	–	
Output Capacitance		C_{OSS}	–	484	–	

NXH007F120M3F2PTHG

ELECTRICAL CHARACTERISTICS ($T_J = 25^\circ\text{C}$ unless otherwise noted) (continued)

Parameter	Test Conditions	Symbol	Min	Typ	Max	Unit	
SiC MOSFET CHARACTERISTICS							
Total Gate Charge	$V_{GS} = -3/18\text{ V}$, $V_{DS} = 800\text{ V}$, $I_D = 40\text{ A}$	$Q_{G(TOTAL)}$	–	407	–	nC	
Gate–Source Charge		Q_{GS}	–	42	–		
Gate–Drain Charge		Q_{GD}	–	93	–		
Internal Gate Resistance	$f = 1\text{ MHz}$	R_{GINT}	–	0.5	–	Ω	
Turn–on Delay Time	$T_J = 25^\circ\text{C}$ $V_{DS} = 800\text{ V}$, $I_D = 120\text{ A}$ $V_{GS} = -3/18\text{ V}$, $R_G = 2\ \Omega$	$t_{d(on)}$	–	37.2	–	ns	
Rise Time		t_r	–	12	–		
Turn–off Delay Time		$t_{d(off)}$	–	121.6	–		
Fall Time		t_f	–	13.2	–		
Turn–on Switching Loss per Pulse		E_{ON}	–	1.69	–		mJ
Turn–off Switching Loss per Pulse		E_{OFF}	–	0.5	–		
Turn–on Delay Time	$T_J = 150^\circ\text{C}$ $V_{DS} = 800\text{ V}$, $I_D = 120\text{ A}$ $V_{GS} = -3/18\text{ V}$, $R_G = 2\ \Omega$	$t_{d(on)}$	–	34.8	–	ns	
Rise Time		t_r	–	14	–		
Turn–off Delay Time		$t_{d(off)}$	–	131.6	–		
Fall Time		t_f	–	14	–		
Turn–on Switching Loss per Pulse		E_{ON}	–	2.23	–		mJ
Turn off Switching Loss per Pulse		E_{OFF}	–	0.6	–		
Diode Forward Voltage	$I_{SD} = 120\text{ A}$, $T_J = 25^\circ\text{C}$, $V_{GS} = -3\text{ V}$	V_{SD}	–	5.03	6	V	
	$I_{SD} = 120\text{ A}$, $T_J = 125^\circ\text{C}$, $V_{GS} = -3\text{ V}$		–	4.81	–		
	$I_{SD} = 120\text{ A}$, $T_J = 150^\circ\text{C}$, $V_{GS} = -3\text{ V}$		–	4.73	–		
Thermal Resistance – Chip–to–Case	M1, M2, M3, M4	R_{thJC}	–	0.269	–	$^\circ\text{C/W}$	
Thermal Resistance – Chip–to–Heatsink	Thermal grease, Thickness = 2 Mil $\pm 2\%$, A = 2.8 W/mK	R_{thJH}	–	0.462	–	$^\circ\text{C/W}$	

THERMISTOR CHARACTERISTICS

Nominal Resistance	$T = 25^\circ\text{C}$	R_{25}	–	5	–	k Ω
	$T = 100^\circ\text{C}$	R_{100}	–	493	–	Ω
	$T = 150^\circ\text{C}$	R_{150}	–	159.5	–	Ω
Deviation of R_{100}	$T = 100^\circ\text{C}$	$\Delta R/R$	–5	–	5	%
Power Dissipation – Recommended Limit	0.15 mA, Non–self–heating Effect	P_D	–	0.1	–	mW
Power Dissipation – Absolute Maximum	5 mA	P_D	–	34.2	–	mW
Power Dissipation Constant			–	1.4	–	mW/K
B–value	B(25/50), tolerance $\pm 2\%$		–	3375	–	K
B–value	B(25/100), tolerance $\pm 2\%$		–	3436	–	K

Product parametric performance is indicated in the Electrical Characteristics for the listed test conditions, unless otherwise noted. Product performance may not be indicated by the Electrical Characteristics if operated under different conditions.

ORDERING INFORMATION

Orderable Part Number	Marking	Package	Shipping
NXH007F120M3F2PTHG	NXH007F120M3F2PTHG	F2FULLBR: Case 180HU Press–fit Pins with pre–applied thermal interface material (TIM) (Pb–Free / Halide Free)	20 Units / Blister Tray

NXH007F120M3F2PTHG

TYPICAL CHARACTERISTIC (M1/M2 SiC MOSFET CHARACTERISTIC)

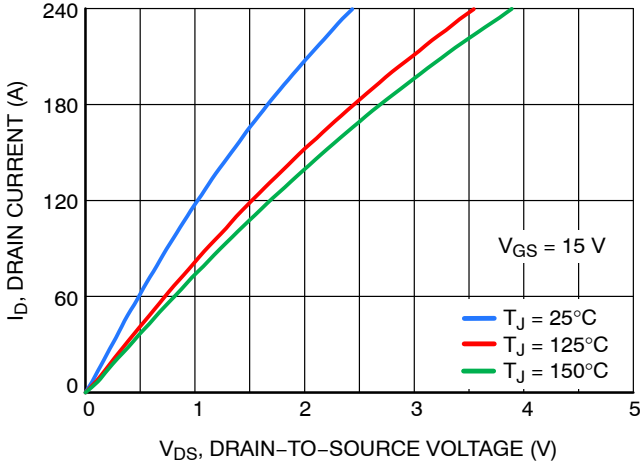

Figure 2. MOSFET Typical Output Characteristic $V_{GS} = 15\text{ V}$

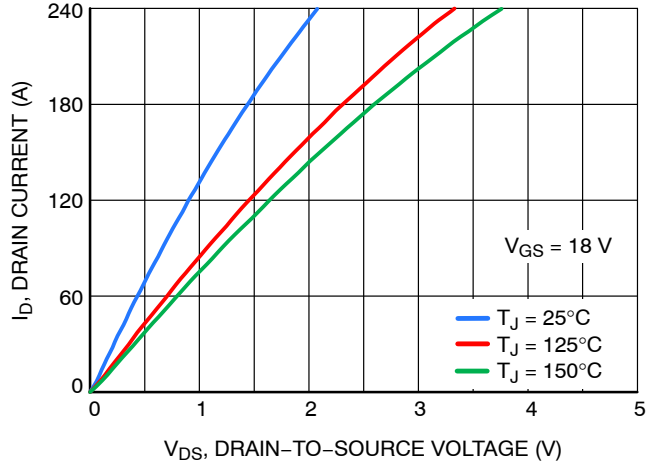

Figure 3. MOSFET Typical Output Characteristic $V_{GS} = 18\text{ V}$

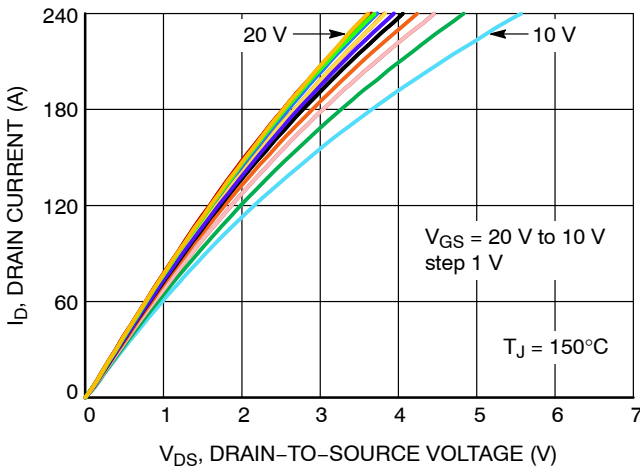

Figure 4. MOSFET Typical Output Characteristic $V_{GS} = \text{var.}$

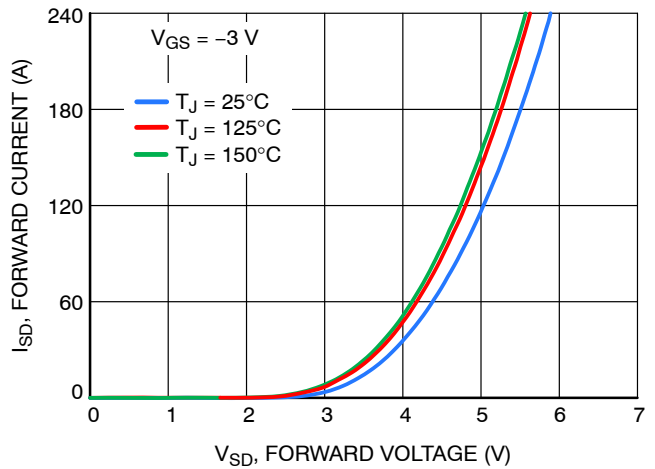

Figure 5. Body Diode Forward Characteristic

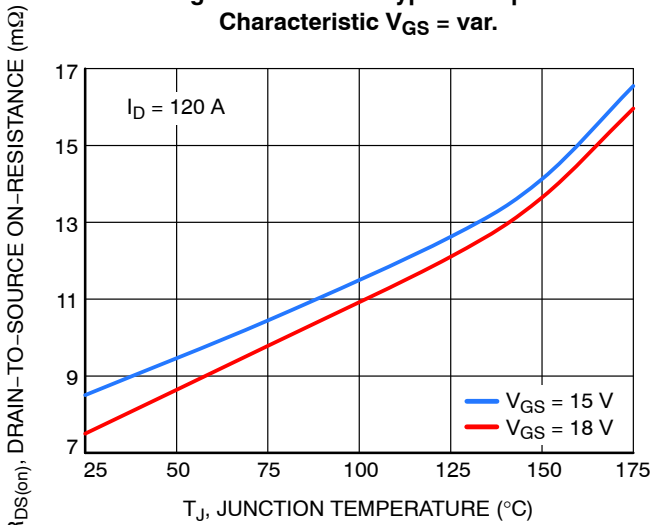

Figure 6. $R_{DS(ON)}$ Drain-to-Source ON Resistance vs. Junction Temperature

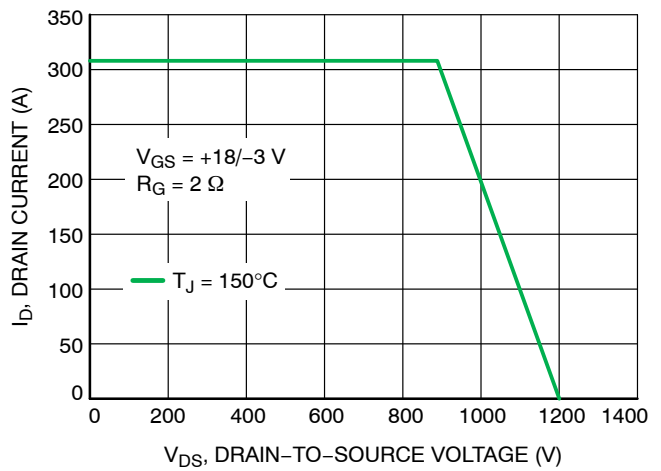

Figure 7. Reverse Bias Safe Operating Area (RBSOA)

NXH007F120M3F2PTHG

TYPICAL CHARACTERISTIC (M1/M2 SiC MOSFET CHARACTERISTIC)

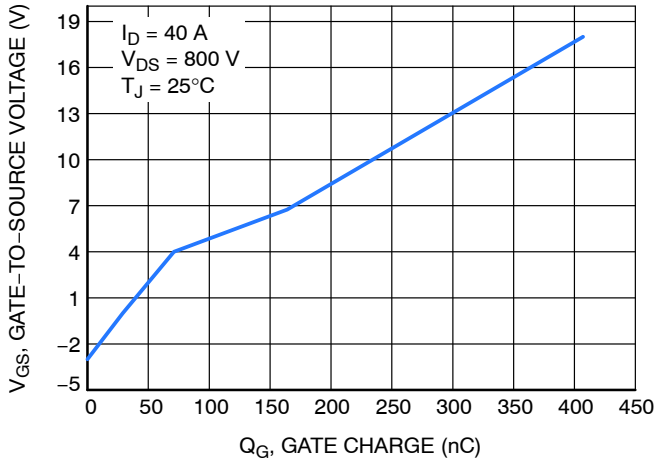

Figure 8. Gate-to-Source Voltage vs. Gate Charge

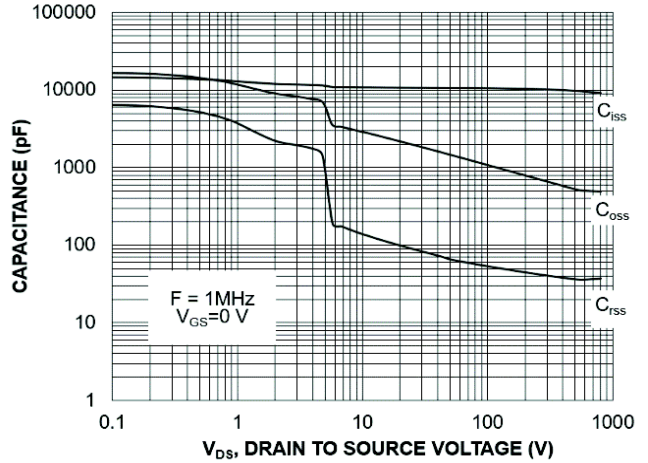

Figure 9. Capacitance vs. Voltage Drain-to-Source

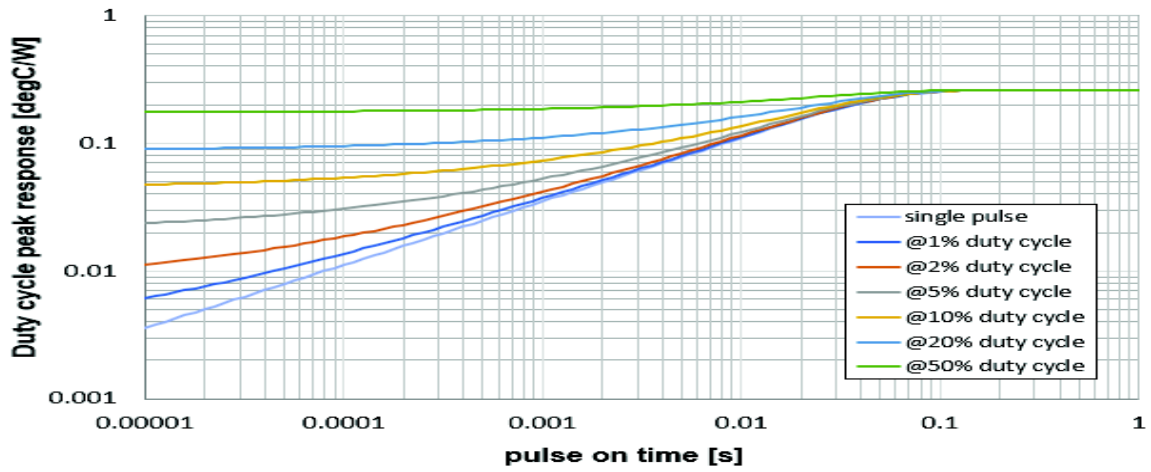

Figure 10. Duty Cycle Response vs. Pulse On Time

NXH007F120M3F2PTHG

TYPICAL CHARACTERISTIC (M1/M2 SiC MOSFET CHARACTERISTIC)

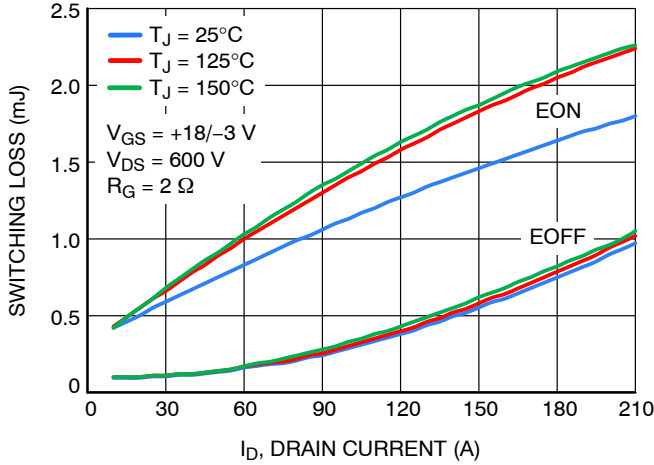

Figure 11. Switching Loss vs. Drain Current
 $V_{DS} = 600 \text{ V}$

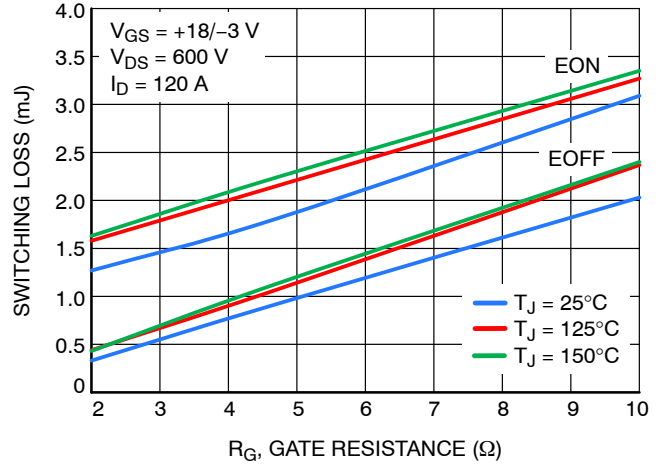

Figure 12. Switching Loss vs. Gate Resistance
 $V_{DS} = 600 \text{ V}$

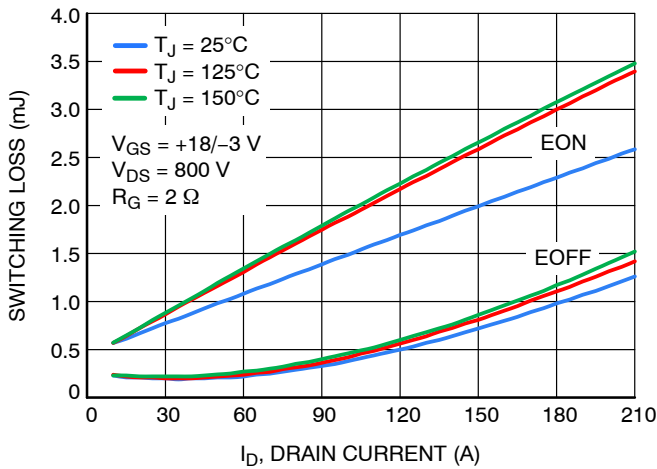

Figure 13. Switching Loss vs. Drain Current
 $V_{DS} = 800 \text{ V}$

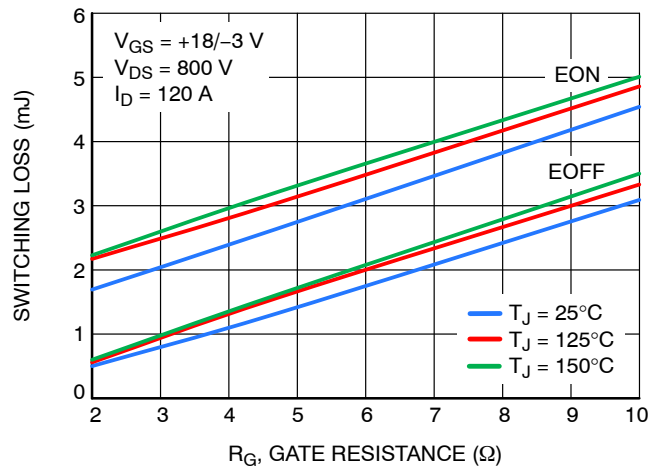

Figure 14. Switching Loss vs. Gate Resistance
 $V_{DS} = 800 \text{ V}$

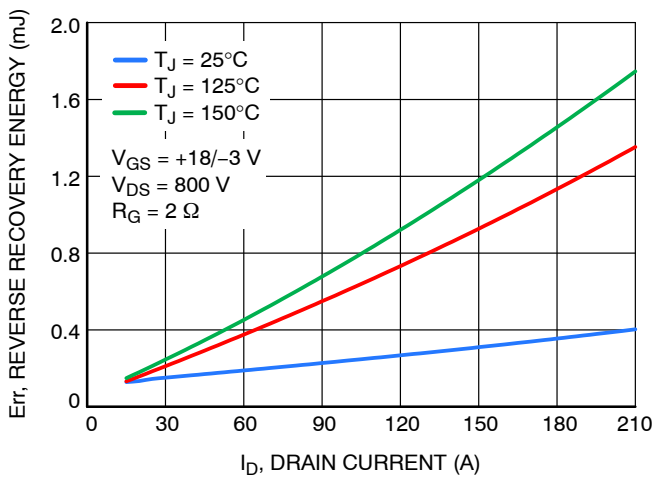

Figure 15. Reverse Recovery Energy vs. Drain Current
 $V_{DS} = 800 \text{ V}$

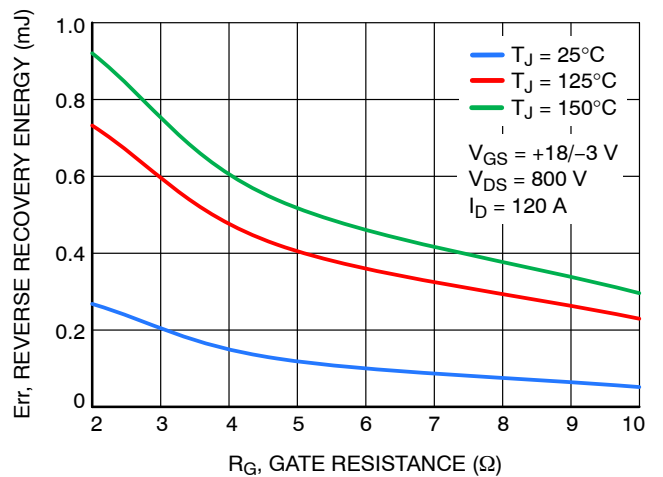

Figure 16. Reverse Recovery Energy vs. Gate Resistance
 $V_{DS} = 800 \text{ V}$

NXH007F120M3F2PTHG

TYPICAL CHARACTERISTIC (M1/M2 SiC MOSFET CHARACTERISTIC)

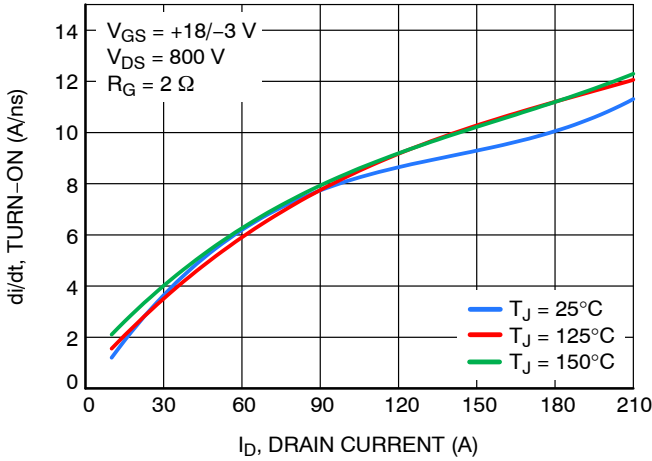

Figure 17. di/dt Turn ON vs. Drain Current
 $V_{DS} = 800 \text{ V}$

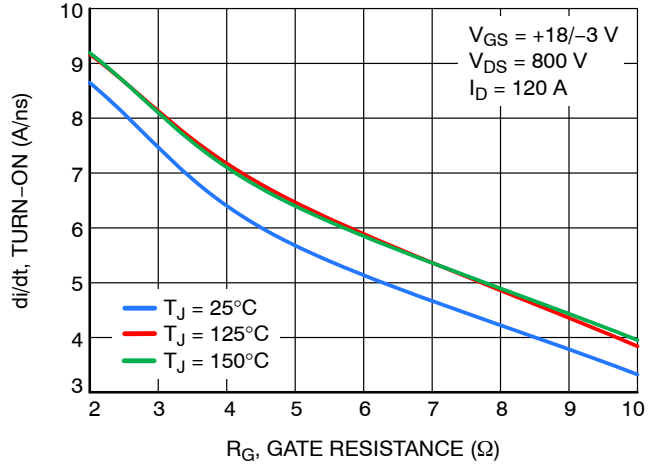

Figure 18. di/dt Turn ON vs. Gate Resistance
 $V_{DS} = 800 \text{ V}$

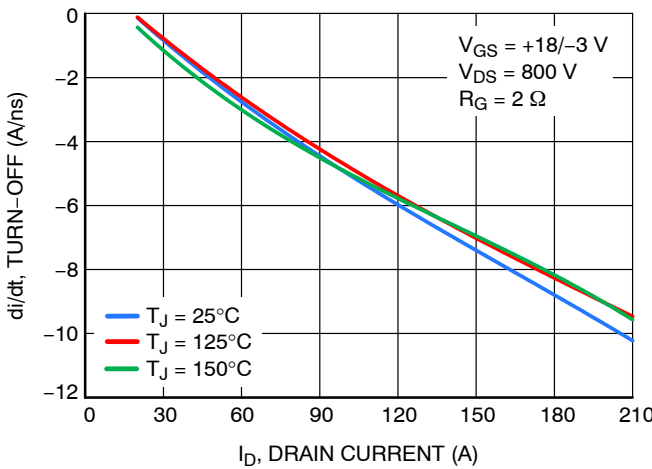

Figure 19. di/dt Turn OFF vs. Drain Current
 $V_{DS} = 800 \text{ V}$

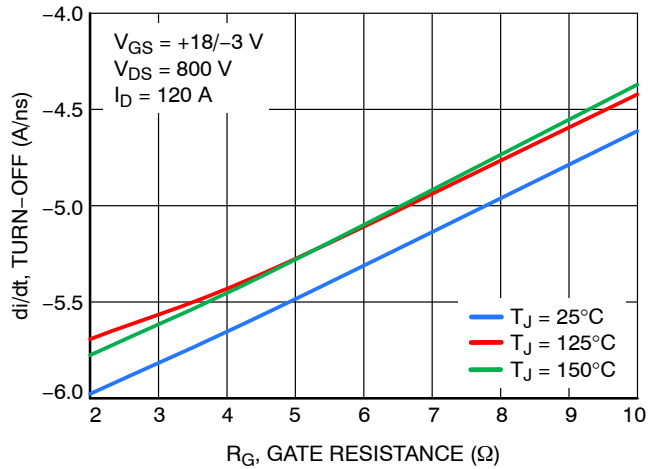

Figure 20. di/dt Turn OFF vs. Gate Resistance
 $V_{DS} = 800 \text{ V}$

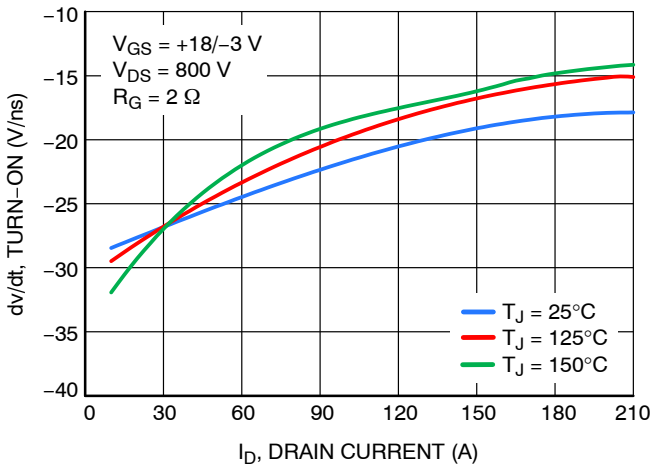

Figure 21. dv/dt Turn ON vs. Drain Current
 $V_{DS} = 800 \text{ V}$

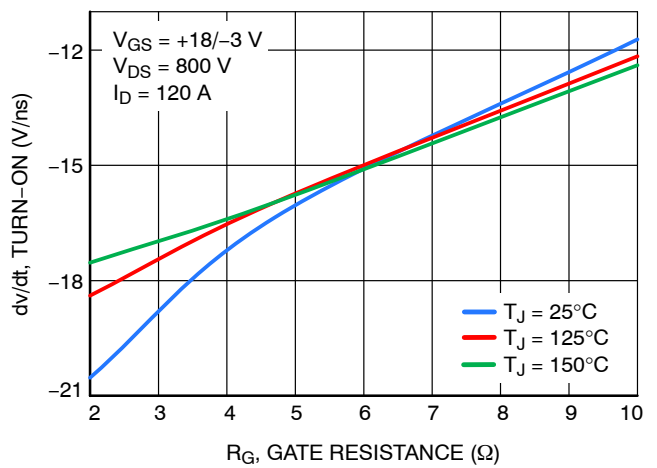

Figure 22. dv/dt Turn ON vs. Gate Resistance
 $V_{DS} = 800 \text{ V}$

NXH007F120M3F2PTHG

TYPICAL CHARACTERISTIC (M1/M2 SiC MOSFET CHARACTERISTIC)

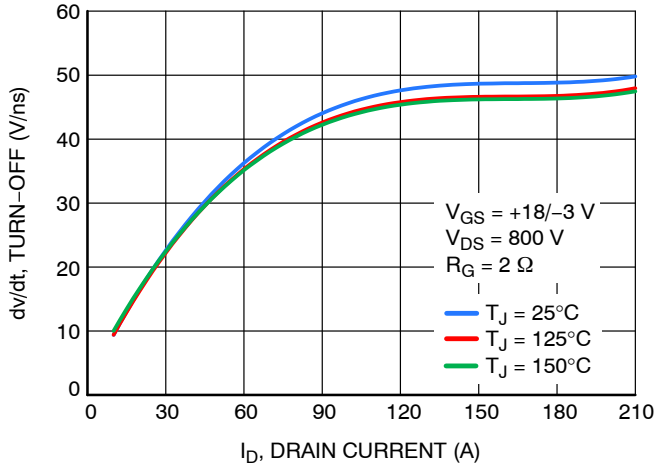

Figure 23. dv/dt Turn OFF vs. Drain Current
 $V_{DS} = 800\text{ V}$

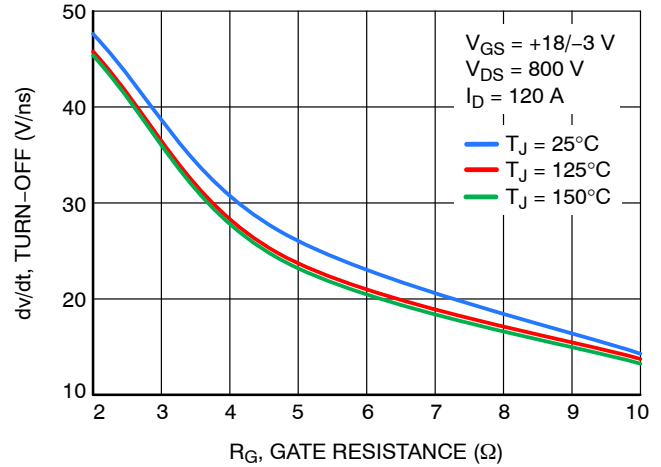

Figure 24. dv/dt Turn OFF vs. Gate Resistance
 $V_{DS} = 800\text{ V}$

Table 1. CAUER NETWORKS

Cauer Element #	Rth (K/W)	Cth (Ws/K)
1	0.0197	0.0062
2	0.0360	0.0335
3	0.0915	0.0468
4	0.1151	0.1685
5	0.0162	0.1198

NXH007F120M3F2PTHG

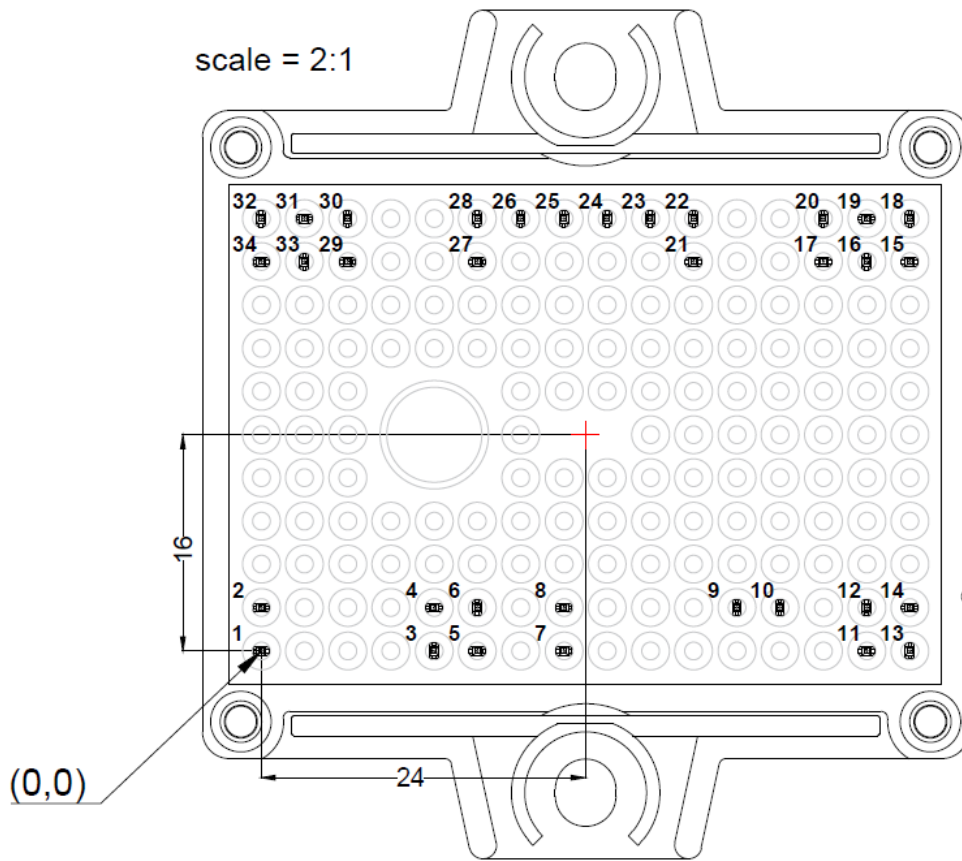

Figure 25.

Pin position

Pin #	X	Y	Function	Pin #	X	Y	Function
1	0	0	TH1	18	48	32	DC-2
2	0	3.2	TH2	19	44.8	32	DC-2
3	12.8	0	AC1	20	41.6	32	DC-2
4	12.8	3.2	AC1	21	32	28.8	DC+
5	16	0	AC1	22	32	32	DC+
6	16	3.2	AC1	23	28.8	32	DC+
7	22.4	0	G1	24	25.6	32	DC+
8	22.4	3.2	S1	25	22.4	32	DC+
9	35.2	3.2	G3	26	19.2	32	DC+
10	38.4	3.2	S3	27	16	28.8	DC+
11	44.8	0	AC2	28	16	32	DC+
12	44.8	3.2	AC2	29	6.4	28.8	DC-1
13	48	0	AC2	30	6.4	32	DC-1
14	48	3.2	AC2	31	3.2	32	DC-1
15	48	28.8	G4	32	0	32	DC-1
16	44.8	28.8	S4	33	3.2	28.8	S2
17	41.6	28.8	DC-2	34	0	28.8	G2

Figure 26.

MECHANICAL CASE OUTLINE

PACKAGE DIMENSIONS



PIM34 56.70x42.50x12.00
CASE 180HU
ISSUE A

DATE 07 FEB 2024

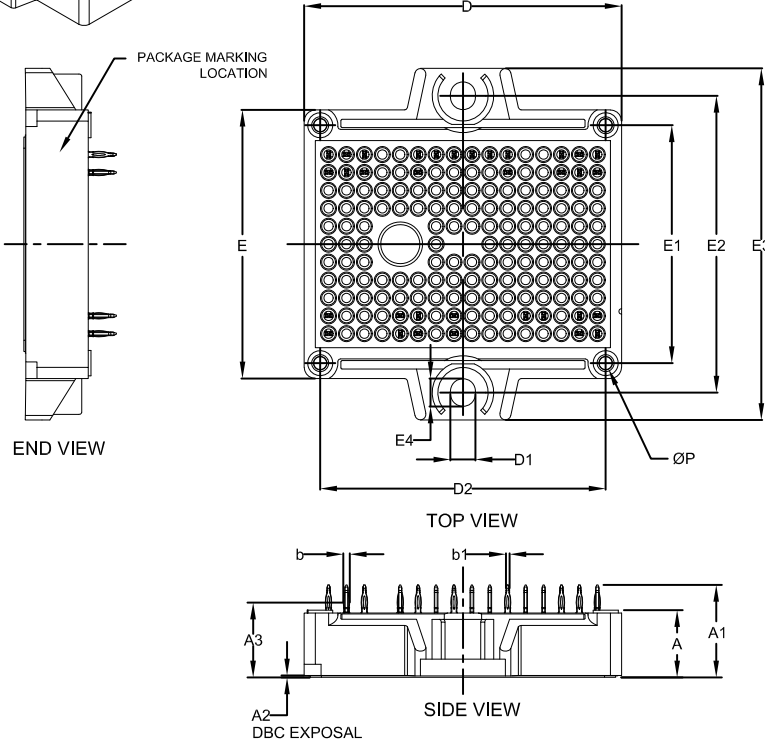
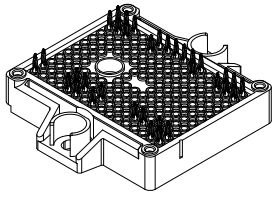

NOTES:

1. CONTROLLING DIMENSION: MILLIMETERS
2. PIN POSITION TOLERANCE IS $\pm 0.4\text{mm}$
3. PRESS FIT PIN

DIM	MILLIMETERS		
	MIN.	NOM.	MAX.
A	11.65	12.00	12.35
A1	16.10	16.50	16.90
A2	0.00	0.35	0.60
A3	12.85	13.35	13.85
b	1.15	1.20	1.25
b1	0.59	0.64	0.69
D	56.40	56.70	57.00
D1	4.40	4.50	4.60
D2	50.85	51.00	51.15
E	47.70	48.00	48.30
E1	42.35	42.50	42.65
E2	52.90	53.00	53.10
E3	62.30	62.80	63.30
E4	4.90	5.00	5.10
P	2.20	2.30	2.40

GENERIC MARKING DIAGRAM*

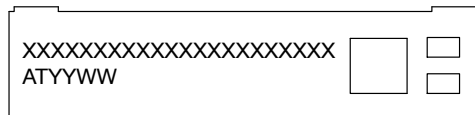

FRONTSIDE MARKING

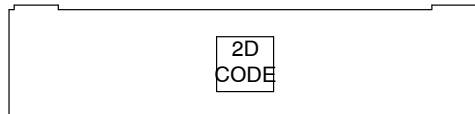

BACKSIDE MARKING

XXXXX = Specific Device Code
 AT = Assembly & Test Site Code
 YYWW = Year and Work Week Code

*This information is generic. Please refer to device data sheet for actual part marking. Pb-Free indicator, "G" or microdot "▪", may or may not be present. Some products may not follow the Generic Marking.

DOCUMENT NUMBER:	98AON57392H	Electronic versions are uncontrolled except when accessed directly from the Document Repository. Printed versions are uncontrolled except when stamped "CONTROLLED COPY" in red.
DESCRIPTION:	PIM34 56.70x42.50x12.00	PAGE 1 OF 2

onsemi and ONSEMI are trademarks of Semiconductor Components Industries, LLC dba onsemi or its subsidiaries in the United States and/or other countries. onsemi reserves the right to make changes without further notice to any products herein. onsemi makes no warranty, representation or guarantee regarding the suitability of its products for any particular purpose, nor does onsemi assume any liability arising out of the application or use of any product or circuit, and specifically disclaims any and all liability, including without limitation special, consequential or incidental damages. onsemi does not convey any license under its patent rights nor the rights of others.

MECHANICAL CASE OUTLINE
PACKAGE DIMENSIONS



PIM34 56.70x42.50x11.50
CASE 180HU
ISSUE A

DATE 07 FEB 2024

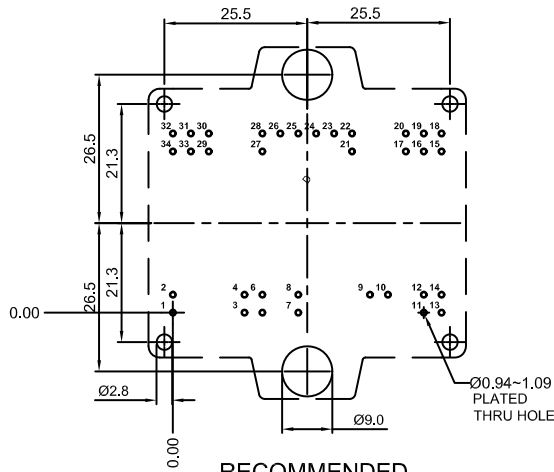

RECOMMENDED MOUNTING PATTERN

* For additional information on our Pb-Free strategy and soldering details, please download the ON Semiconductor Soldering and Mounting Techniques Reference Manual, SOLDERRM/D.

Note2:

Pin	X	Y	Pin	X	Y
1	0	0	18	48	32
2	0	3.2	19	44.8	32
3	12.8	0	20	41.6	32
4	12.8	3.2	21	32	28.8
5	16	0	22	32	32
6	16	3.2	23	28.8	32
7	22.4	0	24	25.6	32
8	22.4	3.2	25	22.4	32
9	35.2	3.2	26	19.2	32
10	38.4	3.2	27	16	28.8
11	44.8	0	28	16	32
12	44.8	3.2	29	6.4	28.8
13	48	0	30	6.4	32
14	48	3.2	31	3.2	32
15	48	28.8	32	0	32
16	44.8	28.8	33	3.2	28.8
17	41.6	28.8	34	0	28.8

DOCUMENT NUMBER:	98AON57392H	Electronic versions are uncontrolled except when accessed directly from the Document Repository. Printed versions are uncontrolled except when stamped "CONTROLLED COPY" in red.
DESCRIPTION:	PIM34 56.70x42.50x11.50	PAGE 2 OF 2

onsemi and ONSEMI are trademarks of Semiconductor Components Industries, LLC dba onsemi or its subsidiaries in the United States and/or other countries. onsemi reserves the right to make changes without further notice to any products herein. onsemi makes no warranty, representation or guarantee regarding the suitability of its products for any particular purpose, nor does onsemi assume any liability arising out of the application or use of any product or circuit, and specifically disclaims any and all liability, including without limitation special, consequential or incidental damages. onsemi does not convey any license under its patent rights nor the rights of others.

onsemi, **Onsemi**, and other names, marks, and brands are registered and/or common law trademarks of Semiconductor Components Industries, LLC dba "**onsemi**" or its affiliates and/or subsidiaries in the United States and/or other countries. **onsemi** owns the rights to a number of patents, trademarks, copyrights, trade secrets, and other intellectual property. A listing of **onsemi**'s product/patent coverage may be accessed at www.onsemi.com/site/pdf/Patent-Marking.pdf. **onsemi** reserves the right to make changes at any time to any products or information herein, without notice. The information herein is provided "as-is" and **onsemi** makes no warranty, representation or guarantee regarding the accuracy of the information, product features, availability, functionality, or suitability of its products for any particular purpose, nor does **onsemi** assume any liability arising out of the application or use of any product or circuit, and specifically disclaims any and all liability, including without limitation special, consequential or incidental damages. Buyer is responsible for its products and applications using **onsemi** products, including compliance with all laws, regulations and safety requirements or standards, regardless of any support or applications information provided by **onsemi**. "Typical" parameters which may be provided in **onsemi** data sheets and/or specifications can and do vary in different applications and actual performance may vary over time. All operating parameters, including "Typicals" must be validated for each customer application by customer's technical experts. **onsemi** does not convey any license under any of its intellectual property rights nor the rights of others. **onsemi** products are not designed, intended, or authorized for use as a critical component in life support systems or any FDA Class 3 medical devices or medical devices with a same or similar classification in a foreign jurisdiction or any devices intended for implantation in the human body. Should Buyer purchase or use **onsemi** products for any such unintended or unauthorized application, Buyer shall indemnify and hold **onsemi** and its officers, employees, subsidiaries, affiliates, and distributors harmless against all claims, costs, damages, and expenses, and reasonable attorney fees arising out of, directly or indirectly, any claim of personal injury or death associated with such unintended or unauthorized use, even if such claim alleges that **onsemi** was negligent regarding the design or manufacture of the part. **onsemi** is an Equal Opportunity/Affirmative Action Employer. This literature is subject to all applicable copyright laws and is not for resale in any manner.

ADDITIONAL INFORMATION

TECHNICAL PUBLICATIONS:

Technical Library: www.onsemi.com/design/resources/technical-documentation
onsemi Website: www.onsemi.com

ONLINE SUPPORT: www.onsemi.com/support

For additional information, please contact your local Sales Representative at www.onsemi.com/support/sales