

# Silicon Carbide (SiC) Module – 15 mohm SiC M3S MOSFET, 1200 V, 4-PACK Full Bridge Topology, F1 Package

## Product Preview

### NXH015F120M3F1PTG

The NXH015F120M3F1PTG is a power module containing 15 mΩ/1200 V SiC MOSFET full-bridge and a thermistor with Al<sub>2</sub>O<sub>3</sub> DBC in an F1 package.

#### Features

- 15 mΩ / 1200 V M3S SiC MOSFET Full-Bridge
- Al<sub>2</sub>O<sub>3</sub> DBC
- Thermistor
- Options with Pre-Applied Thermal Interface Material (TIM) and without Pre-Applied TIM
- Press-Fit Pins
- These Devices are Pb-Free, Halide Free and are RoHS Compliant

#### Typical Applications

- Solar Inverter
- Uninterruptible Power Supplies
- Electric Vehicle Charging Stations
- Industrial Power

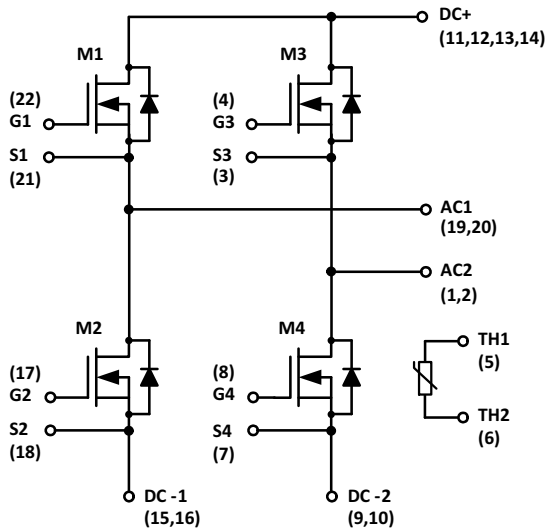
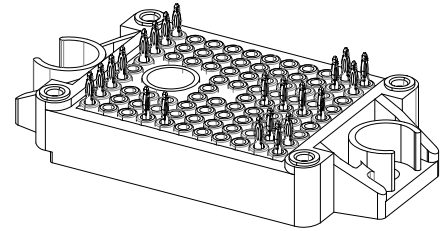

Figure 1. NXH015F120M3F1PTG Schematic Diagram

This document contains information on a product under development. onsemi reserves the right to change or discontinue this product without notice.

#### PACKAGE PICTURE



PIM22 33.8x42.5 (PRESS FIT)  
CASE 180HL

#### MARKING DIAGRAM

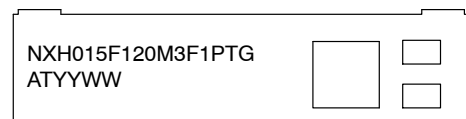

NXH015F120M3F1PTG = Specific Device Code  
AT = Assembly & Test Site Code  
YYWW = Year and Work Week Code

#### PIN CONNECTIONS

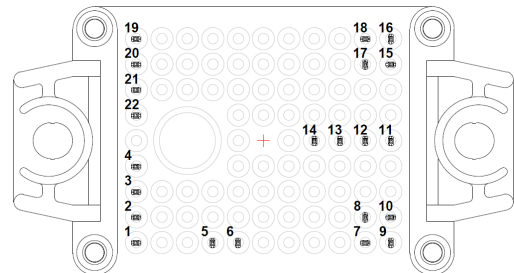

See Pin Function Description for pin names

#### ORDERING INFORMATION

See detailed ordering and shipping information on page 4 of this data sheet.

# NXH015F120M3F1PTG

## PIN FUNCTION DESCRIPTION

Pin	Name	Description
1	AC2	Center point of full bridge 2
2	AC2	Center point of full bridge 2
3	S3	M3 Kelvin Source (High Side switch)
4	G3	M3 Gate (High Side switch)
5	TH1	Thermistor Connection 1
6	TH2	Thermistor Connection 2
7	S4	M4 Kelvin Source (Low side switch)
8	G4	M4 Gate (Low side switch)
9	DC-2	DC Negative Bus connection
10	DC-2	DC Negative Bus connection
11	DC+	DC Positive Bus connection
12	DC+	DC Positive Bus connection
13	DC+	DC Positive Bus connection
14	DC+	DC Positive Bus connection
15	DC-1	DC Negative Bus connection
16	DC-1	DC Negative Bus connection
17	G2	M2 Gate (Low side switch)
18	S2	M2 Kelvin Source (Low side switch)
19	AC1	Center point of full bridge 1
20	AC1	Center point of full bridge 1
21	S1	M1 Kelvin Source (High side switch)
22	G1	M1 Gate (High side switch)

## MAXIMUM RATINGS

Rating	Symbol	Value	Unit
<b>SIC MOSFET</b>			
Drain-Source Voltage	$V_{DSS}$	1200	V
Gate-Source Voltage	$V_{GS}$	+22/-10	V
Continuous Drain Current @ $T_C = 80^\circ\text{C}$ ( $T_J = 175^\circ\text{C}$ )	$I_D$	77	A
Pulsed Drain Current ( $T_J = 175^\circ\text{C}$ )	$I_{Dpulse}$	232	A
Maximum Power Dissipation ( $T_J = 175^\circ\text{C}$ )	$P_{tot}$	198	W
Minimum Operating Junction Temperature	$T_{JMIN}$	-40	$^\circ\text{C}$
Maximum Operating Junction Temperature	$T_{JMAX}$	175	$^\circ\text{C}$

## THERMAL PROPERTIES

Storage Temperature Range	$T_{stg}$	-40 to 150	$^\circ\text{C}$
---------------------------	-----------	------------	------------------

## INSULATION PROPERTIES

Isolation Test Voltage, $t = 1$ s, 60 Hz	$V_{is}$	4800	$V_{RMS}$
Creepage Distance		12.7	mm
CTI		600	
Substrate Ceramic Material		$\text{Al}_2\text{O}_3$	
Substrate Ceramic Material Thickness		0.32	mm

Stresses exceeding those listed in the Maximum Ratings table may damage the device. If any of these limits are exceeded, device functionality should not be assumed, damage may occur and reliability may be affected.

1. Refer to ELECTRICAL CHARACTERISTICS, RECOMMENDED OPERATING RANGES and/or APPLICATION INFORMATION for Safe Operating parameters.

# NXH015F120M3F1PTG

## RECOMMENDED OPERATING RANGES

Rating	Symbol	Min	Max	Unit
Module Operating Junction Temperature	$T_J$	-40	150	°C

Functional operation above the stresses listed in the Recommended Operating Ranges is not implied. Extended exposure to stresses beyond the Recommended Operating Ranges limits may affect device reliability.

## ELECTRICAL CHARACTERISTICS ( $T_J = 25^\circ\text{C}$ unless otherwise noted)

Parameter	Test Conditions	Symbol	Min	Typ	Max	Unit
-----------	-----------------	--------	-----	-----	-----	------

### SiC MOSFET CHARACTERISTICS

Zero Gate Voltage Drain Current	$V_{GS} = 0\text{ V}, V_{DS} = 1200\text{ V}, T_J = 25^\circ\text{C}$	$I_{DSS}$	-	-	200	$\mu\text{A}$	
Drain-Source On Resistance	$V_{GS} = 18\text{ V}, I_D = 60\text{ A}, T_J = 25^\circ\text{C}$	$R_{DS(ON)}$	-	14.8	19	$\text{m}\Omega$	
	$V_{GS} = 18\text{ V}, I_D = 60\text{ A}, T_J = 125^\circ\text{C}$		-	24.7	-		
	$V_{GS} = 18\text{ V}, I_D = 60\text{ A}, T_J = 150^\circ\text{C}$		-	28.7	-		
	$V_{GS} = 18\text{ V}, I_D = 60\text{ A}, T_J = 175^\circ\text{C}$		-	33	-		
Gate-Source Threshold Voltage	$V_{GS} = V_{DS}, I_D = 30\text{ mA}$	$V_{GS(TH)}$	2.04	2.4	4.4	V	
Recommended Gate Voltage		$V_{GOP}$	-3	-	+18	V	
Gate-to-Source Leakage Current	$V_{GS} = +22/-10\text{ V}, V_{DS} = 0\text{ V}$	$I_{GSS}$	-	-	$\pm 2$	$\mu\text{A}$	
Input Capacitance	$V_{GS} = 0\text{ V}, f = 1\text{ MHz}, V_{DS} = 800\text{ V}$	$C_{ISS}$	-	4696	-	$\text{pF}$	
Reverse Transfer Capacitance		$C_{RSS}$	-	20.1	-		
Output Capacitance		$C_{OSS}$	-	287	-		
Total Gate Charge	$V_{GS} = -3/18\text{ V}, V_{DS} = 800\text{ V}, I_D = 30\text{ A}$	$Q_{G(TOTAL)}$	-	211	-	nC	
Gate-Source Charge		$Q_{GS}$	-	16	-		
Gate-Drain Charge		$Q_{GD}$	-	50	-		
Internal Gate Resistance	$f = 1\text{ MHz}$	$R_{GINT}$	-	1.65	-	$\Omega$	
Turn-on Delay Time	$T_J = 25^\circ\text{C},$ $V_{DS} = 800\text{ V}, I_D = 60\text{ A},$ $V_{GS} = -3\text{ V}/18\text{ V}, R_G = 2.2\ \Omega$	$t_{d(on)}$	-	33.3	-	ns	
Rise Time		$t_r$	-	8.6	-		
Turn-off Delay Time		$t_{d(off)}$	-	103	-		
Fall Time		$t_f$	-	7.5	-		
Turn-on Switching Loss per Pulse		$E_{ON}$	-	0.67	-		mJ
Turn off Switching Loss per Pulse		$E_{OFF}$	-	0.28	-		
Turn-on Delay Time	$T_J = 150^\circ\text{C},$ $V_{DS} = 800\text{ V}, I_D = 60\text{ A},$ $V_{GS} = -3\text{ V}/18\text{ V}, R_G = 2.2\ \Omega$	$t_{d(on)}$	-	31.9	-	ns	
Rise Time		$t_r$	-	8.1	-		
Turn-off Delay Time		$t_{d(off)}$	-	111	-		
Fall Time		$t_f$	-	8.1	-		
Turn-on Switching Loss per Pulse		$E_{ON}$	-	1.06	-		mJ
Turn off Switching Loss per Pulse		$E_{OFF}$	-	0.33	-		
Diode Forward Voltage	$V_{GS} = -3\text{ V}, I_{SD} = 60\text{ A}, T_J = 25^\circ\text{C}$	$V_{SD}$	-	4.67	6.2	V	
	$V_{GS} = -3\text{ V}, I_{SD} = 60\text{ A}, T_J = 125^\circ\text{C}$		-	4.45	-		
	$V_{GS} = -3\text{ V}, I_{SD} = 60\text{ A}, T_J = 150^\circ\text{C}$		-	4.4	-		
Thermal Resistance - Chip-to-Case	M1, M2, M3, M4	$R_{thJC}$	-	0.48	-	°C/W	
Thermal Resistance - Chip-to-Heatsink		$R_{thJH}$	-	0.86	-	°C/W	

### THERMISTOR CHARACTERISTICS

Nominal Resistance	$T = 25^\circ\text{C}$	$R_{25}$	-	5	-	$\text{k}\Omega$
	$T = 100^\circ\text{C}$	$R_{100}$	-	493	-	$\Omega$
	$T = 150^\circ\text{C}$	$R_{150}$	-	159.5	-	$\Omega$
Deviation of $R_{100}$	$T = 100^\circ\text{C}$	$\Delta R/R$	-5	-	5	%
Power Dissipation - Recommended Limit	0.15 mA, Non-self-heating Effect	$P_D$	-	0.1	-	mW

# NXH015F120M3F1PTG

## ELECTRICAL CHARACTERISTICS (continued) (T<sub>J</sub> = 25 °C unless otherwise noted)

Parameter	Test Conditions	Symbol	Min	Typ	Max	Unit
-----------	-----------------	--------	-----	-----	-----	------

### THERMISTOR CHARACTERISTICS

Power Dissipation – Absolute Maximum	5 mA			34.2		mW
Power Dissipation Constant			–	1.4	–	mW/K
B-value	B(25/50), tolerance ±2%		–	3375	–	K
B-value	B(25/100), tolerance ±2%		–	3436	–	K

Product parametric performance is indicated in the Electrical Characteristics for the listed test conditions, unless otherwise noted. Product performance may not be indicated by the Electrical Characteristics if operated under different conditions.

### ORDERING INFORMATION

Orderable Part Number	Marking	Package	Shipping
NXH015F120M3F1PTG	NXH015F120M3F1PTG	F1FULLBR: Case 180HL Press-fit Pins with pre-applied thermal interface material (TIM) (Pb-Free and Halide-Free)	28 Units / Blister Tray

# NXH015F120M3F1PTG

## TYPICAL CHARACTERISTICS

M1, M2, M3, M4 SIC MOSFET CHARACTERISTIC

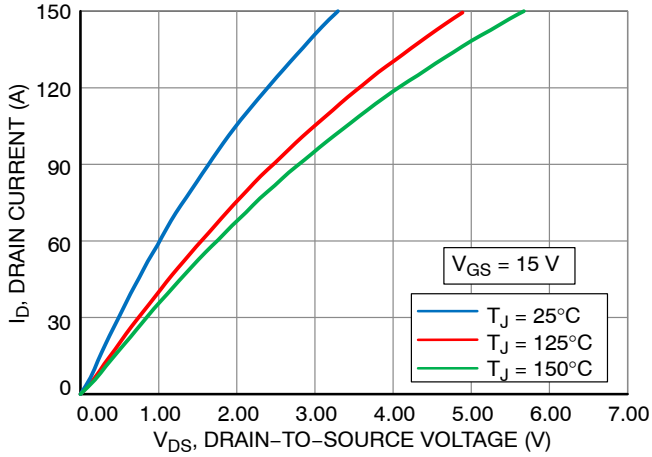

**Figure 2. MOSFET Typical Output Characteristic  $V_{GS} = 15\text{ V}$**

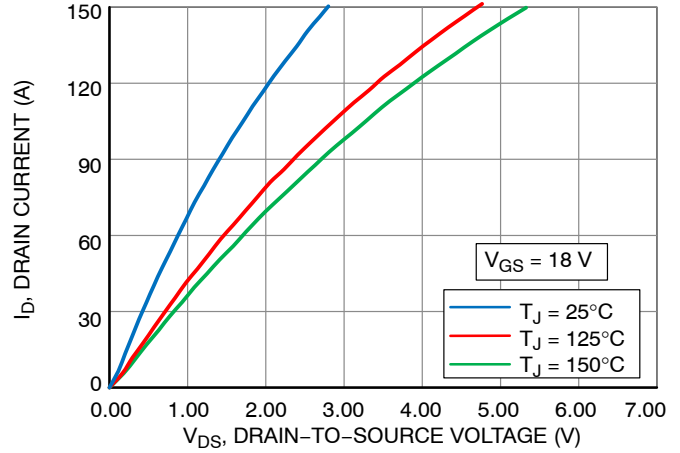

**Figure 3. MOSFET Typical Output Characteristic  $V_{GS} = 18\text{ V}$**

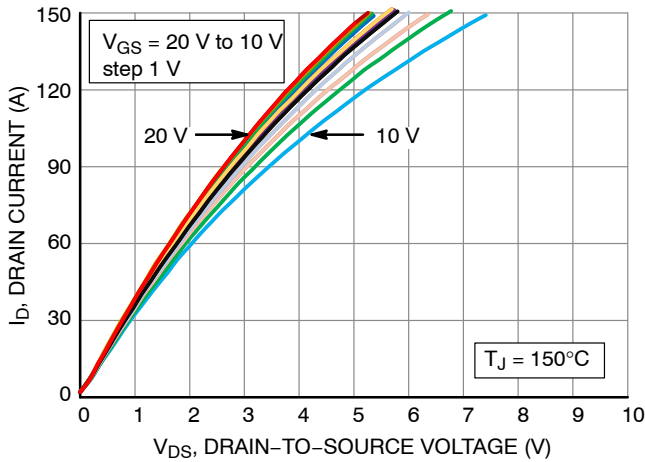

**Figure 4. MOSFET Typical Output Characteristic  $V_{GS} = \text{var.}$**

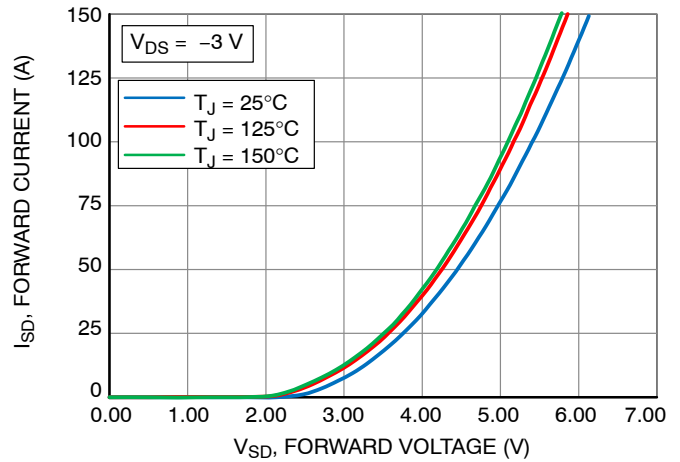

**Figure 5. Body Diode Forward Characteristic**

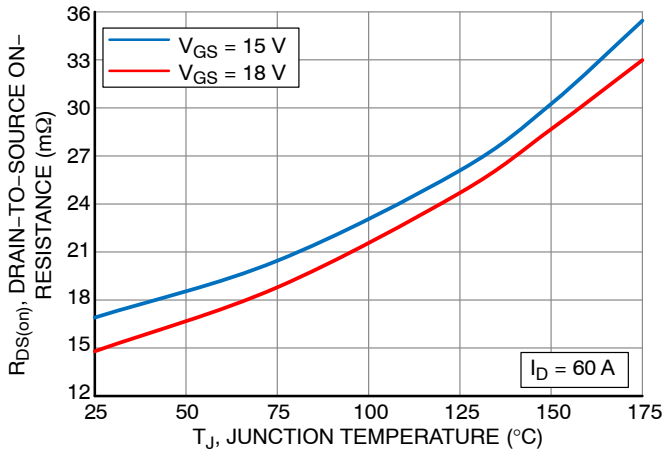

**Figure 6.  $R_{DS(on)}$  Drain-to-Source ON Resistance vs. Junction Temperature**

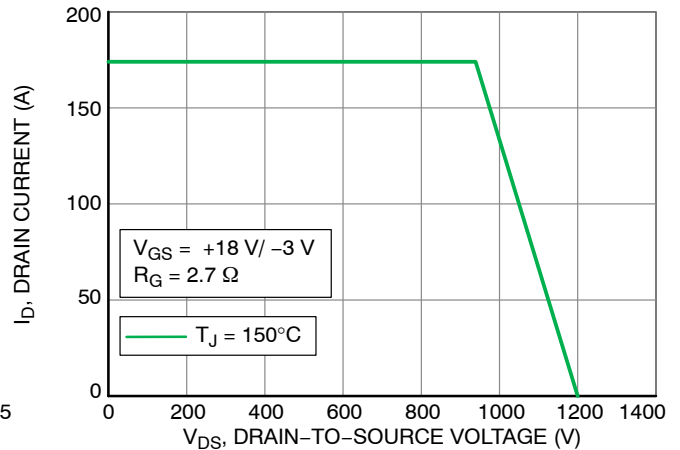
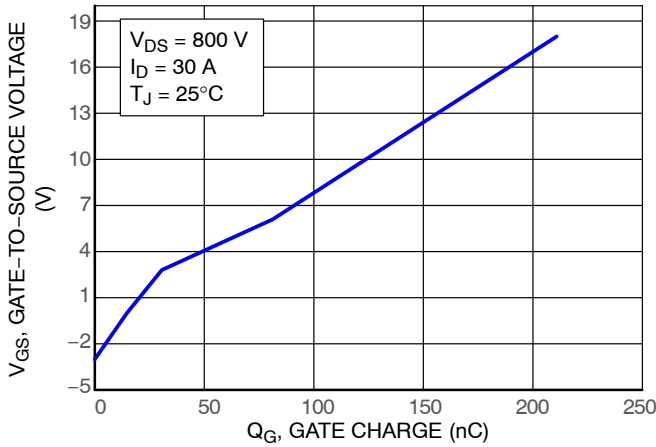

**Figure 7. Reverse Bias Safe Operating Area (RBSOA)**

# NXH015F120M3F1PTG

## TYPICAL CHARACTERISTICS

M1, M2, M3, M4 SIC MOSFET CHARACTERISTIC



**Figure 8. Gate-to-Source Voltage vs. Gate Charge**

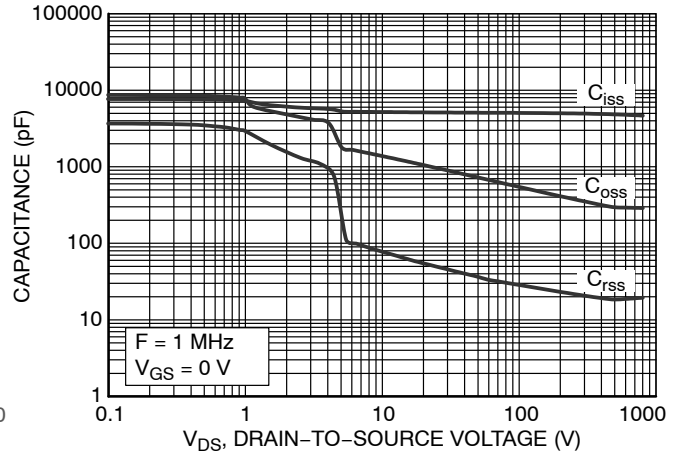

**Figure 9. Capacitance vs. Drain-to-Source Voltage**

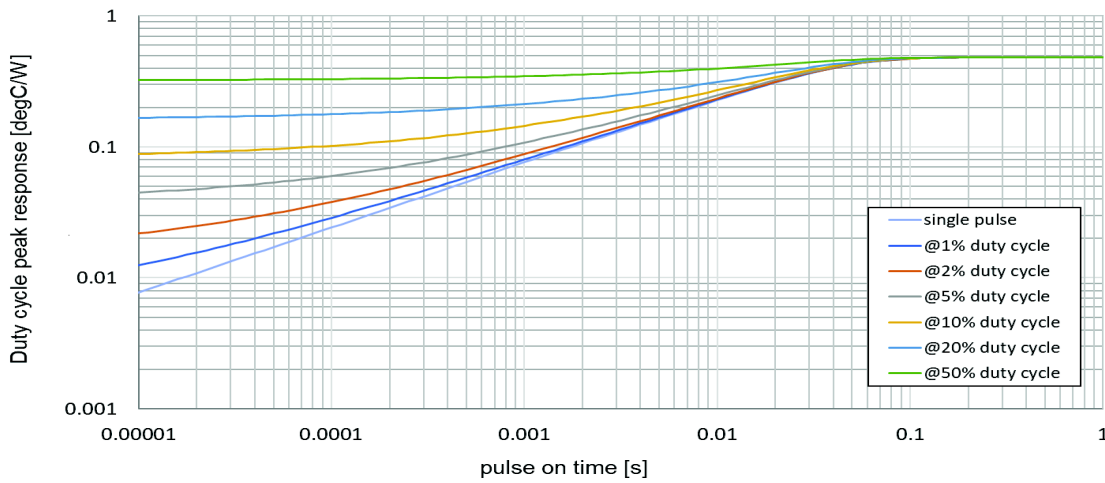

**Figure 10. Duty Cycle vs. Junction-to-Case Transient Thermal Impedance**

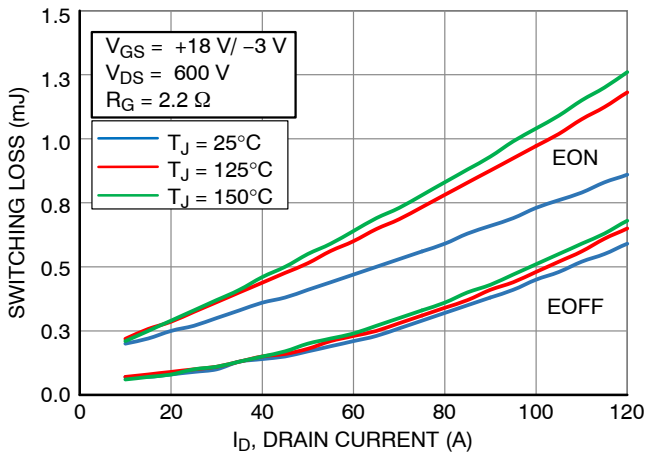

**Figure 11. Switching Loss vs. Drain Current**  
 $V_{DS} = 600 V$

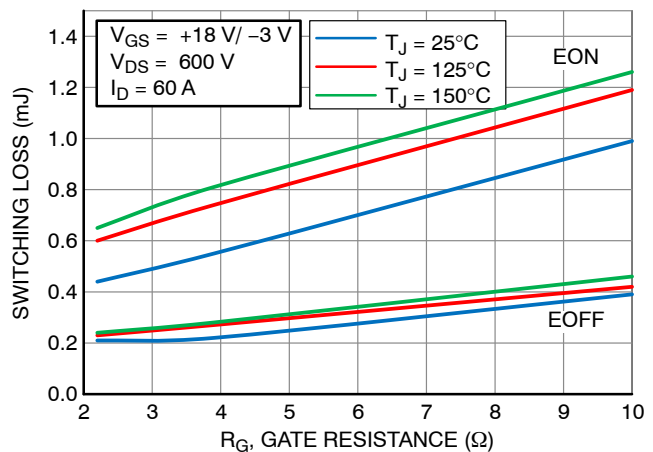
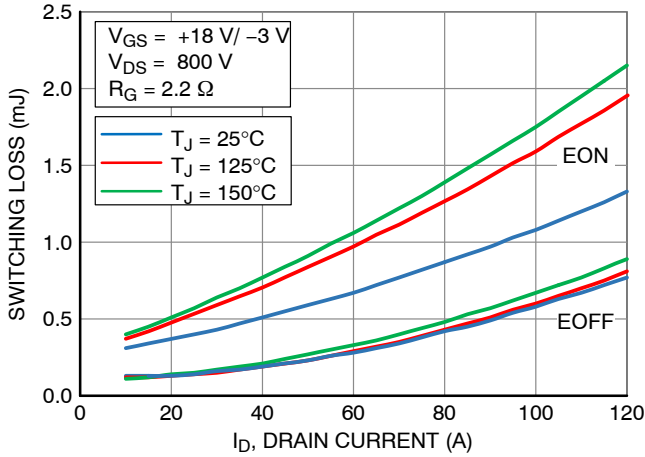

**Figure 12. Switching Loss vs. Gate Resistance**  
 $V_{DS} = 600 V$

# NXH015F120M3F1PTG

## TYPICAL CHARACTERISTICS

M1, M2, M3, M4 SIC MOSFET CHARACTERISTIC



**Figure 13. Switching Loss vs. Drain Current**  
 $V_{DS} = 800\text{ V}$

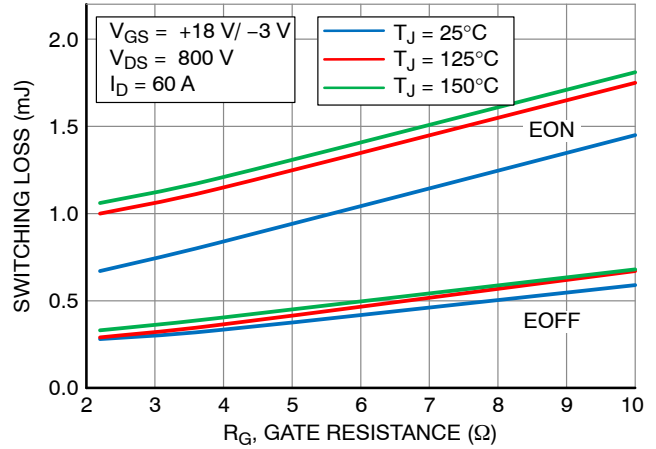

**Figure 14. Switching Loss vs. Gate Resistance**  
 $V_{DS} = 800\text{ V}$

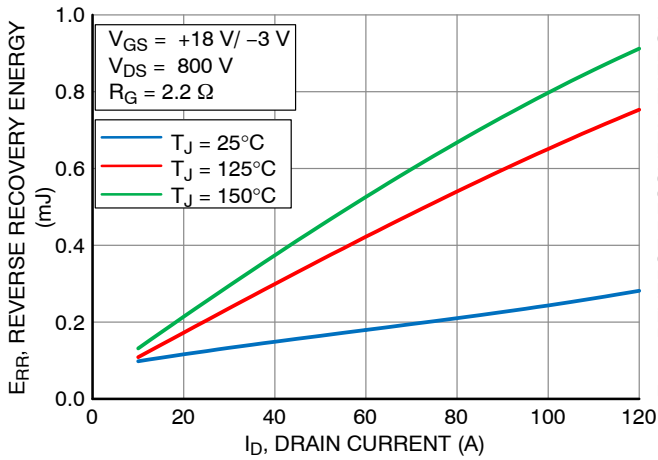

**Figure 15. Reverse Recovery Energy vs. Drain Current**  
 $V_{DS} = 800\text{ V}$

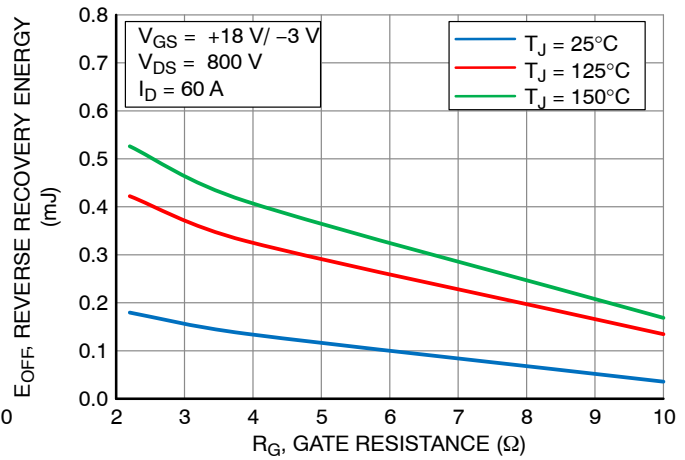

**Figure 16. Reverse Recovery Energy vs. Gate Resistance**  
 $V_{DS} = 800\text{ V}$

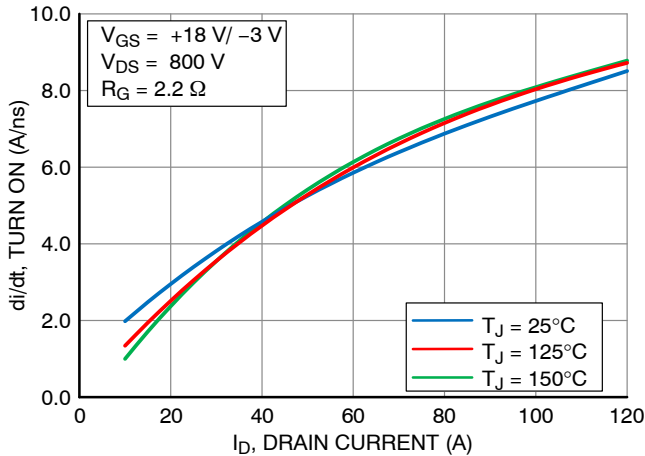

**Figure 17. di/dt Turn ON vs. Drain Current**  
 $V_{DS} = 800\text{ V}$

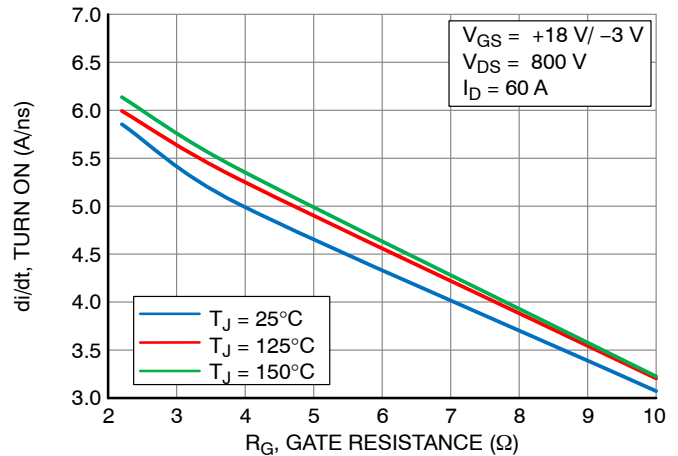
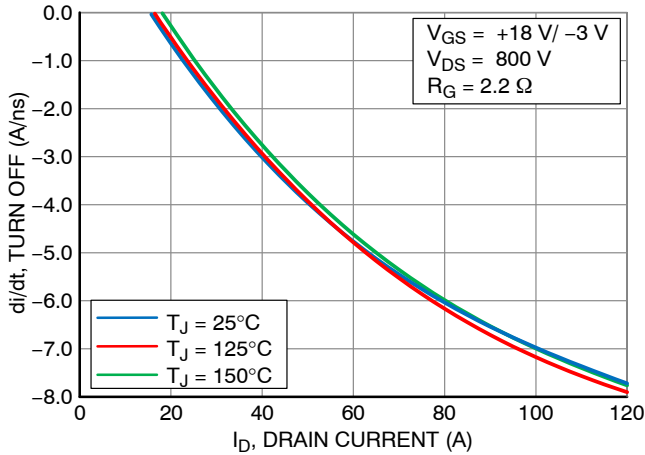

**Figure 18. di/dt Turn ON vs. Gate Resistance**  
 $V_{DS} = 800\text{ V}$

# NXH015F120M3F1PTG

## TYPICAL CHARACTERISTICS

M1, M2, M3, M4 SIC MOSFET CHARACTERISTIC



**Figure 19. di/dt Turn OFF vs. Drain Current**  
 $V_{DS} = 800 V$

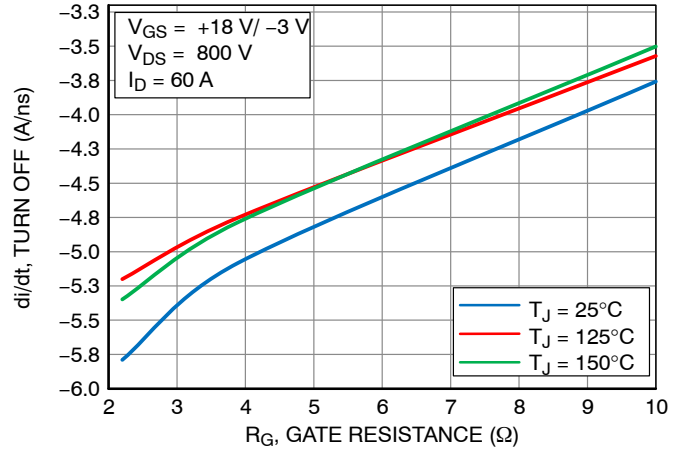

**Figure 20. di/dt Turn OFF vs. Gate Resistance**  
 $V_{DS} = 800 V$

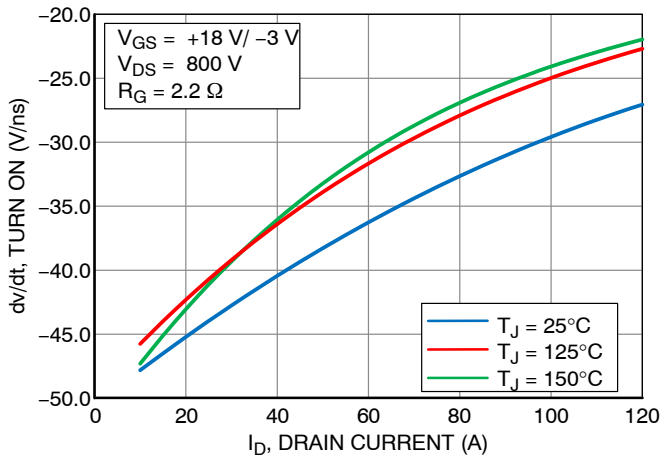

**Figure 21. dv/dt Turn ON vs. Drain Current**  
 $V_{DS} = 800 V$

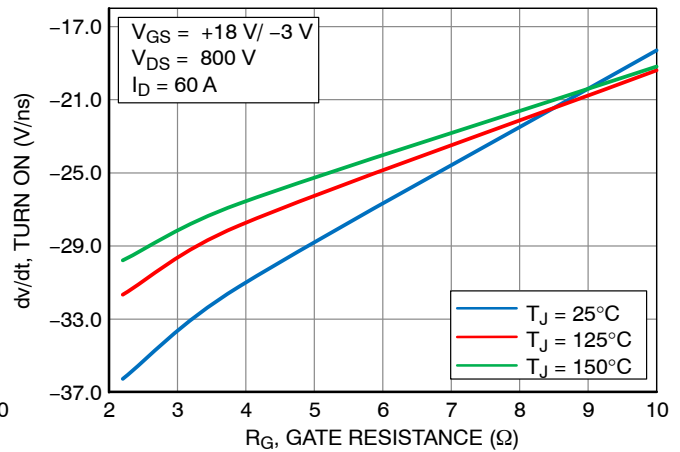

**Figure 22. dv/dt Turn ON vs. Gate Resistance**  
 $V_{DS} = 800 V$

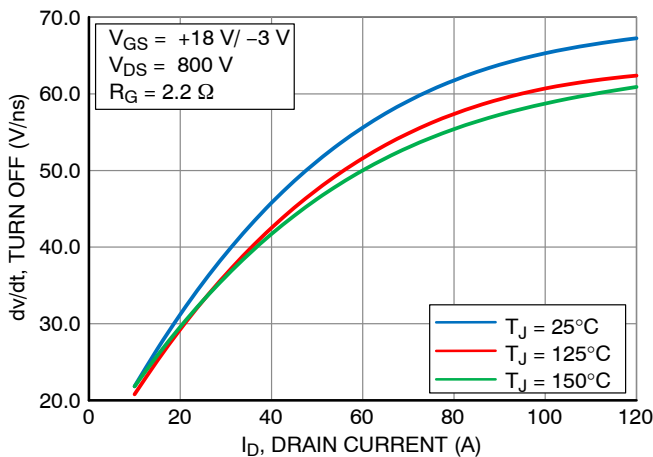

**Figure 23. dv/dt Turn OFF vs. Drain Current**  
 $V_{DS} = 800 V$

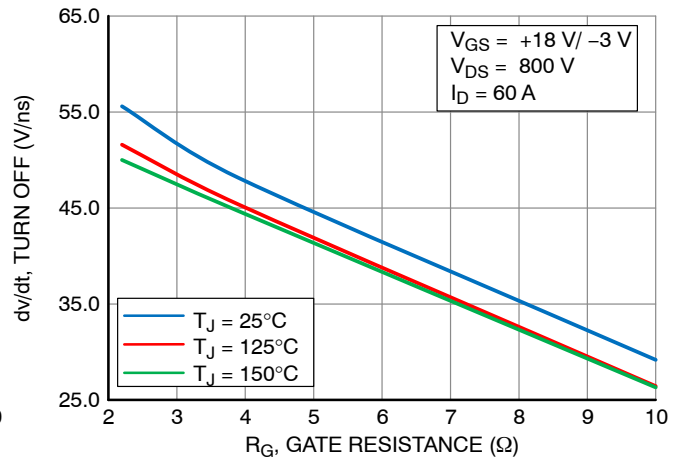

**Figure 24. dv/dt Turn OFF vs. Gate Resistance**  
 $V_{DS} = 800 V$



# NXH015F120M3F1PTG

**Table 1. CAUER NETWORKS**

Cauer Element #	Rth (K/W)	Cth (Ws/K)
1	0.0004413	0.0013801
2	0.0029539	0.0003074
3	0.0066160	0.0005317
4	0.0326540	0.0026575
5	0.0988730	0.0081213
6	0.1850100	0.0419900
7	0.0817340	1.1620000

## PIN POSITION INFORMATION

scale = 2.5 : 1

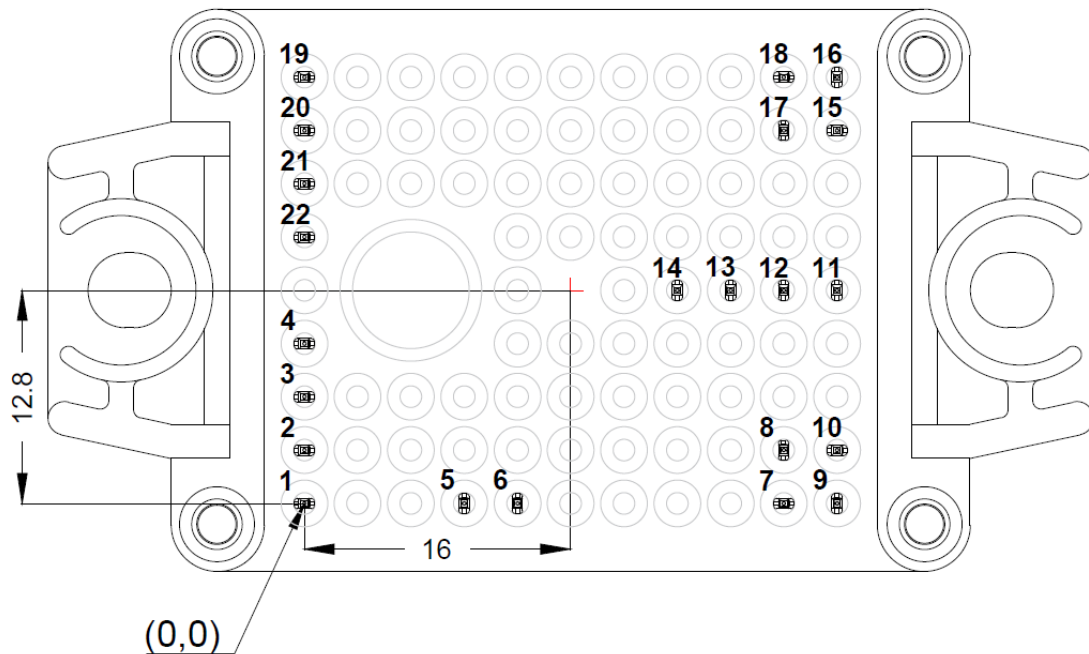

## PIN POSITION

Pin #	X	Y	Function	Pin #	X	Y	Function
1	0	0	AC2	12	28.8	12.8	DC+
2	0	3.2	AC2	13	25.6	12.8	DC+
3	0	6.4	S3	14	22.4	12.8	DC+
4	0	9.6	G3	15	32	22.4	DC-1
5	9.6	0	TH1	16	32	25.6	DC-1
6	12.8	0	TH2	17	28.8	22.4	G2
7	28.8	0	S4	18	28.8	25.6	S2
8	28.8	3.2	G4	19	0	25.6	AC1
9	32	0	DC-2	20	0	22.4	AC1
10	32	3.2	DC-2	21	0	19.2	S1
11	32	12.8	DC+	22	0	16	G1

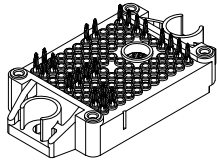

**PIM22 33.80x42.50x10.00**  
**CASE 180HL**  
**ISSUE O**

DATE 29 AUG 2023

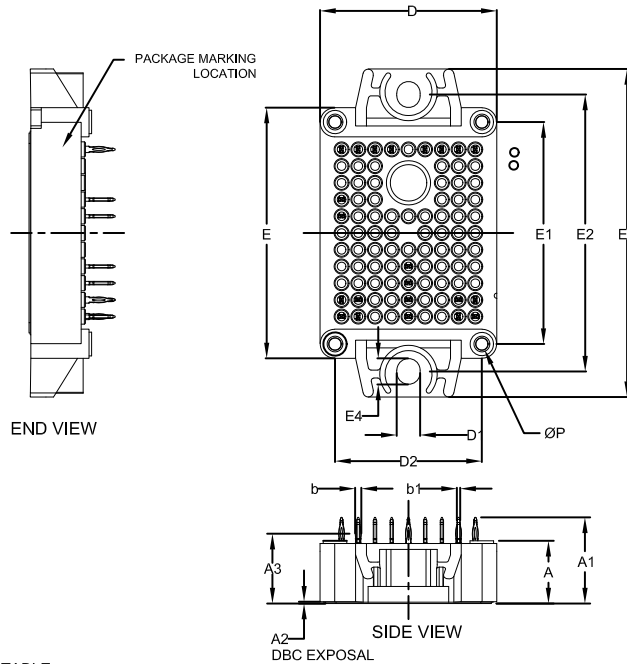

- NOTES:
1. CONTROLLING DIMENSION: MILLIMETERS
  2. PIN POSITION TOLERANCE IS ± 0.4mm
  3. PRESS FIT PIN

DIM	MILLIMETERS		
	MIN.	NOM.	MAX.
A	11.65	12.00	12.35
A1	16.00	16.50	17.00
A2	0.00	0.35	0.60
A3	12.85	13.35	13.85
b	1.15	1.20	1.25
b1	0.59	0.64	0.69
D	33.50	33.80	34.10
D1	4.40	4.50	4.60
D2	27.95	28.10	28.25
E	47.70	48.00	48.30
E1	42.35	42.50	42.65
E2	52.90	53.00	53.10
E3	62.30	62.80	63.30
E4	4.90	5.00	5.10
P	2.20	2.30	2.40

PIN POSITION TABLE:

Pin	X	Y	Function	Pin	X	Y	Function
1	0	0	AC2	12	28.8	12.8	DC+
2	0	3.2	AC2	13	25.6	12.8	DC+
3	0	6.4	S3	14	22.4	12.8	DC+
4	0	9.6	G3	15	32	22.4	DC-1
5	9.6	0	TH1	16	32	25.6	DC-1
6	12.8	0	TH2	17	28.8	22.4	G2
7	28.8	0	S4	18	28.8	25.6	S2
8	28.8	3.2	G4	19	0	25.6	AC1
9	32	0	DC-2	20	0	22.4	AC1
10	32	3.2	DC-2	21	0	19.2	S1
11	32	12.8	DC+	22	0	16	G1

**GENERIC MARKING DIAGRAM\***

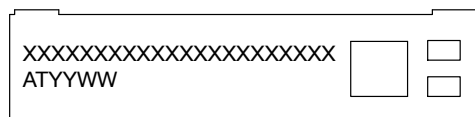

XXXXX = Specific Device Code  
AT = Assembly & Test Site Code  
YYWW = Year and Work Week Code

\*This information is generic. Please refer to device data sheet for actual part marking. Pb-Free indicator, "G" or microdot "•", may or may not be present. Some products may not follow the Generic Marking.

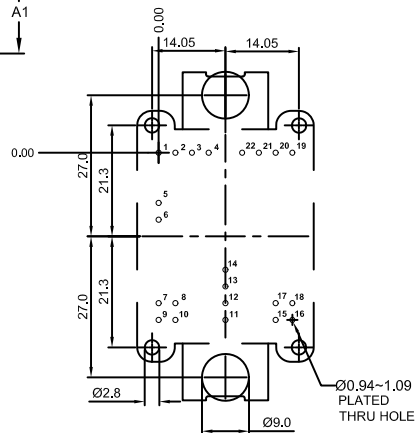

**RECOMMENDED MOUNTING PATTERN**

\* For additional information on our Pb-Free strategy and soldering details, please download the ON Semiconductor Soldering and Mounting Techniques Reference Manual, SOLDERRM/D.

<b>DOCUMENT NUMBER:</b>	<b>98AON57399H</b>	Electronic versions are uncontrolled except when accessed directly from the Document Repository. Printed versions are uncontrolled except when stamped "CONTROLLED COPY" in red.
<b>DESCRIPTION:</b>	<b>PIM22 33.80x42.50x10.00</b>	<b>PAGE 1 OF 1</b>

onsemi and ONSEMI are trademarks of Semiconductor Components Industries, LLC dba onsemi or its subsidiaries in the United States and/or other countries. onsemi reserves the right to make changes without further notice to any products herein. onsemi makes no warranty, representation or guarantee regarding the suitability of its products for any particular purpose, nor does onsemi assume any liability arising out of the application or use of any product or circuit, and specifically disclaims any and all liability, including without limitation special, consequential or incidental damages. onsemi does not convey any license under its patent rights nor the rights of others.

**onsemi**, **Onsemi**, and other names, marks, and brands are registered and/or common law trademarks of Semiconductor Components Industries, LLC dba "**onsemi**" or its affiliates and/or subsidiaries in the United States and/or other countries. **onsemi** owns the rights to a number of patents, trademarks, copyrights, trade secrets, and other intellectual property. A listing of **onsemi**'s product/patent coverage may be accessed at [www.onsemi.com/site/pdf/Patent-Marking.pdf](http://www.onsemi.com/site/pdf/Patent-Marking.pdf). **onsemi** reserves the right to make changes at any time to any products or information herein, without notice. The information herein is provided "as-is" and **onsemi** makes no warranty, representation or guarantee regarding the accuracy of the information, product features, availability, functionality, or suitability of its products for any particular purpose, nor does **onsemi** assume any liability arising out of the application or use of any product or circuit, and specifically disclaims any and all liability, including without limitation special, consequential or incidental damages. Buyer is responsible for its products and applications using **onsemi** products, including compliance with all laws, regulations and safety requirements or standards, regardless of any support or applications information provided by **onsemi**. "Typical" parameters which may be provided in **onsemi** data sheets and/or specifications can and do vary in different applications and actual performance may vary over time. All operating parameters, including "Typicals" must be validated for each customer application by customer's technical experts. **onsemi** does not convey any license under any of its intellectual property rights nor the rights of others. **onsemi** products are not designed, intended, or authorized for use as a critical component in life support systems or any FDA Class 3 medical devices or medical devices with a same or similar classification in a foreign jurisdiction or any devices intended for implantation in the human body. Should Buyer purchase or use **onsemi** products for any such unintended or unauthorized application, Buyer shall indemnify and hold **onsemi** and its officers, employees, subsidiaries, affiliates, and distributors harmless against all claims, costs, damages, and expenses, and reasonable attorney fees arising out of, directly or indirectly, any claim of personal injury or death associated with such unintended or unauthorized use, even if such claim alleges that **onsemi** was negligent regarding the design or manufacture of the part. **onsemi** is an Equal Opportunity/Affirmative Action Employer. This literature is subject to all applicable copyright laws and is not for resale in any manner.

## ADDITIONAL INFORMATION

### TECHNICAL PUBLICATIONS:

Technical Library: [www.onsemi.com/design/resources/technical-documentation](http://www.onsemi.com/design/resources/technical-documentation)  
onsemi Website: [www.onsemi.com](http://www.onsemi.com)

### ONLINE SUPPORT: [www.onsemi.com/support](http://www.onsemi.com/support)

For additional information, please contact your local Sales Representative at [www.onsemi.com/support/sales](http://www.onsemi.com/support/sales)

