

# Si/SiC Hybrid Module – EliteSiC™, 3 Channel Flying Capacitor Boost 1000 V, 200 A IGBT, 1200 V, 60 A SiC Diode, Q2 Package

## NXH600B100H4Q2F2S1G, SNXH600B100H4Q2F2S1G-S

The NXH600B100H4Q2S1G is a Si/SiC Hybrid three channel flying capacitor boost module. Each channel contains two 1000 V, 200 A IGBTs, and two 1200 V, 60 A SiC diodes. The module contains an NTC thermistor.

### Features

- 3-channel Boost in Q2 Package
- Extremely Efficient Trench with Field Stop Technology
- Low Switching Loss Reduces System Power Dissipation
- Module Design Offers High Power Density
- Low Inductive Layout

### Typical Applications

- Solar Inverters
- Uninterruptible Power Supplies Systems

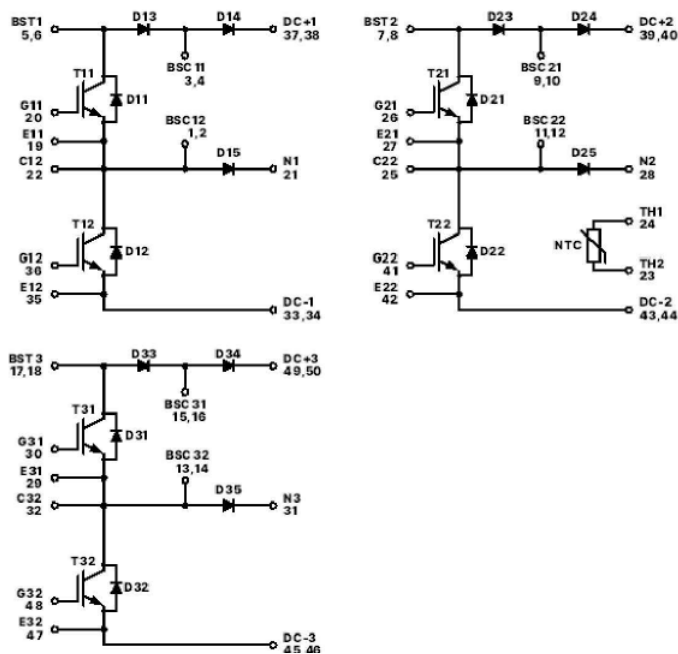
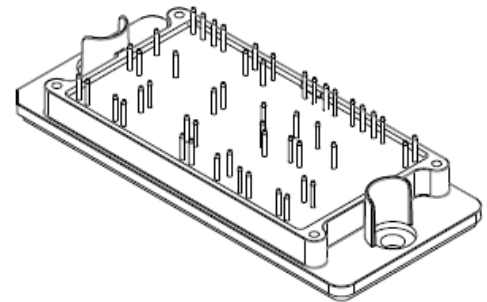
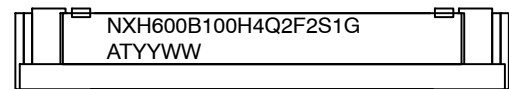


Figure 1. NXH600B100H4Q2F2S1G Schematic Diagram



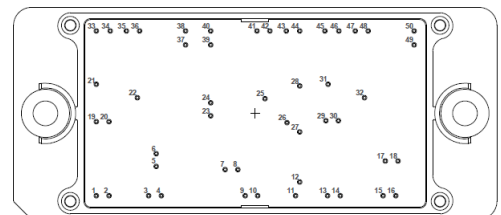
PIM56, 93x47 (SOLDER PIN)  
CASE 180BK

### MARKING DIAGRAM



NXH600B100H4Q2F2S1G = Specific Device Code  
G = Pb-Free Package  
AT = Assembly & Test Site Code  
YYWW = Year and Work Week Code

### PIN CONNECTIONS



### ORDERING INFORMATION

See detailed ordering and shipping information in the package dimensions section on page 4 of this data sheet.

# NXH600B100H4Q2F2S1G, SNXH600B100H4Q2F2S1G-S

**Table 1. ABSOLUTE MAXIMUM RATINGS** (Note 1) ( $T_J = 25^\circ\text{C}$  unless otherwise noted)

| Rating  | Symbol                | Value    | Unit             |
|---|-----------------------|----------|------------------|
| <b>IGBT (T11, T12, T21, T22, T31, T32)</b>  |                       |          |                  |
| Collector-Emitter Voltage   | $V_{CES}$             | 1000     | V                |
| Gate-Emitter Voltage  | $V_{GE}$              | $\pm 20$ | V                |
| Positive Transient Gate-Emitter Voltage ( $t_{\text{pulse}} = 5 \mu\text{s}$ , $D < 0.10$ ) |                       | 30       |                  |
| Continuous Collector Current @ $T_C = 80^\circ\text{C}$                                     | $I_C$                 | 173      | A                |
| Pulsed Peak Collector Current @ $T_C = 80^\circ\text{C}$ ( $T_J = 175^\circ\text{C}$ )      | $I_{C(\text{Pulse})}$ | 519      | A                |
| Maximum Power Dissipation ( $T_J = 175^\circ\text{C}$ )                                     | $P_{\text{tot}}$      | 422      | W                |
| Minimum Junction Temperature  | $T_{J\text{MIN}}$     | -40      | $^\circ\text{C}$ |
| Maximum Junction Temperature (Note 2)   | $T_{J\text{MAX}}$     | 175      | $^\circ\text{C}$ |

**IGBT INVERSE DIODE (D11, D12, D21, D22, D31, D32)**

|   |                   |      |                  |
|---|-------------------|------|------------------|
| Peak Repetitive Reverse Voltage                               | $V_{RRM}$         | 1200 | V                |
| Continuous Forward Current @ $T_C = 80^\circ\text{C}$         | $I_F$             | 66   | A                |
| Repetitive Peak Forward Current ( $T_J = 175^\circ\text{C}$ ) | $I_{FRM}$         | 98   | A                |
| Maximum Power Dissipation ( $T_J = 175^\circ\text{C}$ )       | $P_{\text{tot}}$  | 101  | W                |
| Minimum Junction Temperature                                  | $T_{J\text{MIN}}$ | -40  | $^\circ\text{C}$ |
| Maximum Junction Temperature                                  | $T_{J\text{MAX}}$ | 175  | $^\circ\text{C}$ |

**SILICON CARBIDE SCHOTTKY DIODE (D13, D14, D23, D24, D33, D34)**

|   |                   |      |                  |
|---|-------------------|------|------------------|
| Peak Repetitive Reverse Voltage                               | $V_{RRM}$         | 1200 | V                |
| Continuous Forward Current @ $T_C = 80^\circ\text{C}$         | $I_F$             | 63   | A                |
| Repetitive Peak Forward Current ( $T_J = 175^\circ\text{C}$ ) | $I_{FRM}$         | 189  | A                |
| Maximum Power Dissipation ( $T_J = 175^\circ\text{C}$ )       | $P_{\text{tot}}$  | 204  | W                |
| Minimum Junction Temperature                                  | $T_{J\text{MIN}}$ | -40  | $^\circ\text{C}$ |
| Maximum Junction Temperature                                  | $T_{J\text{MAX}}$ | 175  | $^\circ\text{C}$ |

**START-UP DIODE (D15, D25, D35)**

|   |                   |      |                  |
|---|-------------------|------|------------------|
| Peak Repetitive Reverse Voltage                               | $V_{RRM}$         | 1200 | V                |
| Continuous Forward Current @ $T_C = 80^\circ\text{C}$         | $I_F$             | 35   | A                |
| Repetitive Peak Forward Current ( $T_J = 175^\circ\text{C}$ ) | $I_{FRM}$         | 105  | A                |
| Maximum Power Dissipation ( $T_J = 175^\circ\text{C}$ )       | $P_{\text{tot}}$  | 84   | W                |
| Minimum Junction Temperature                                  | $T_{J\text{MIN}}$ | -40  | $^\circ\text{C}$ |
| Maximum Junction Temperature                                  | $T_{J\text{MAX}}$ | 175  | $^\circ\text{C}$ |

**THERMAL AND INSULATION PROPERTIES**

**THERMAL PROPERTIES**

|   |                  |            |                  |
|---|------------------|------------|------------------|
| Operating Temperature under Switching Condition | $T_{VJOP}$       | -40 to 150 | $^\circ\text{C}$ |
| Storage Temperature range                       | $T_{\text{stg}}$ | -40 to 125 | $^\circ\text{C}$ |

**INSULATION PROPERTIES**

|   |                 |      |                  |
|---|-----------------|------|------------------|
| Isolation test voltage, $t = 1 \text{ sec}$ , 50 Hz | $V_{\text{is}}$ | 4000 | $V_{\text{RMS}}$ |
| Creepage distance                                   |                 | 12.7 | mm               |
| Comparative tracking index                          | CTI             | >600 |                  |

Stresses exceeding those listed in the Maximum Ratings table may damage the device. If any of these limits are exceeded, device functionality should not be assumed, damage may occur and reliability may be affected.

1. Refer to ELECTRICAL CHARACTERISTICS, RECOMMENDED OPERATING RANGES and/or APPLICATION INFORMATION for Safe Operating parameters.
2. Qualification at  $175^\circ\text{C}$  per discrete TO247.

# NXH600B100H4Q2F2S1G, SNXH600B100H4Q2F2S1G-S

**Table 2. ELECTRICAL CHARACTERISTICS** ( $T_J = 25^\circ\text{C}$  unless otherwise noted)

| Parameter | Test Conditions | Symbol | Min | Typ | Max | Unit |
|-----------|-----------------|--------|-----|-----|-----|------|
|-----------|-----------------|--------|-----|-----|-----|------|

**IGBT (T11, T12, T21, T22, T31, T32) CHARACTERISTICS**

|                                       |   |  |             |        |         |               |               |
|---------------------------------------|---|--|-------------|--------|---------|---------------|---------------|
| Collector-Emitter Breakdown Voltage   | $V_{GE} = 0\text{ V}, I_C = 2\text{ mA}$  | $V_{(BR)CES}$  | 1000        | 1150   | -       | V             |               |
| Collector-Emitter Cutoff Current      | $V_{GE} = 0\text{ V}, V_{CE} = 1000\text{ V}$   | $I_{CES}$  | -           | -      | 20      | $\mu\text{A}$ |               |
| Collector-Emitter Saturation Voltage  | $V_{GE} = 15\text{ V}, I_C = 200\text{ A}, T_J = 25^\circ\text{C}$  | $V_{CE(sat)}$  | -           | 1.88   | 2.3     | V             |               |
|                                       | $V_{GE} = 15\text{ V}, I_C = 200\text{ A}, T_J = 150^\circ\text{C}$   |  | -           | 2.4    | -       |               |               |
| Gate-Emitter Threshold Voltage        | $V_{GE} = V_{CE}, I_C = 200\text{ mA}$  | $V_{GE(TH)}$   | 4           | 4.98   | 6       | V             |               |
| Gate Leakage Current                  | $V_{GE} = \pm 20\text{ V}, V_{CE} = 0\text{ V}$   | $I_{GES}$  | -           | -      | 350     | nA            |               |
| Internal Gate Resistor                |   | $r_G$  | -           | 3      | -       | $\Omega$      |               |
| Turn-on Delay Time                    | $T_J = 25^\circ\text{C}$<br>$V_{CE} = 600\text{ V}, I_C = 50\text{ A}$<br>$V_{GE} = -9\text{ V}, 15\text{ V}, R_{Gon} = 9\ \Omega, R_{Goff} = 25\ \Omega$ | $t_{d(on)}$  | -           | 119.75 | -       | ns            |               |
| Rise Time                             |   | $t_r$  | -           | 30.08  | -       |               |               |
| Turn-off Delay Time                   |   | $t_{d(off)}$   | -           | 614.57 | -       |               |               |
| Fall Time                             |   | $t_f$  | -           | 26.85  | -       |               |               |
| Turn-on Switching Loss per Pulse      |   | $E_{on}$   | -           | 860    | -       |               | $\mu\text{J}$ |
| Turn off Switching Loss per Pulse     |   | $E_{off}$  | -           | 1500   | -       |               |               |
| Turn-on Delay Time                    |   | $T_J = 125^\circ\text{C}$<br>$V_{CE} = 600\text{ V}, I_C = 50\text{ A}$<br>$V_{GE} = -9\text{ V}, 15\text{ V}, R_{Gon} = 9\ \Omega, R_{Goff} = 25\ \Omega$ | $t_{d(on)}$ | -      | 119.97  |               | -             |
| Rise Time                             | $t_r$   |  | -           | 32.09  | -       |               |               |
| Turn-off Delay Time                   | $t_{d(off)}$  |  | -           | 706.72 | -       |               |               |
| Fall Time                             | $t_f$   |  | -           | 40.22  | -       |               |               |
| Turn-on Switching Loss per Pulse      | $E_{on}$  |  | -           | 1120   | -       | $\mu\text{J}$ |               |
| Turn off Switching Loss per Pulse     | $E_{off}$   |  | -           | 2750   | -       |               |               |
| Input Capacitance                     | $V_{CE} = 20\text{ V}, V_{GE} = 0\text{ V}, f = 1\text{ MHz}$   |  | $C_{ies}$   | -      | 12687.7 | -             | pF            |
| Output Capacitance                    |   | $C_{oes}$  | -           | 418.0  | -       |               |               |
| Reverse Transfer Capacitance          |   | $C_{res}$  | -           | 73.9   | -       |               |               |
| Total Gate Charge                     | $V_{CE} = 600\text{ V}, I_C = 40\text{ A}, V_{GE} = -15\text{ V} \sim 15\text{ V}$  | $Q_g$  | -           | 680    | -       | nC            |               |
| Thermal Resistance – chip-to-heatsink | Thermal grease,<br>Thickness = 2.1 Mil $\pm 2\%$ , $\lambda = 2.87\text{ W/mK}$   | $R_{thJH}$   | -           | 0.420  | -       | K/W           |               |
| Thermal Resistance – chip-to-case     |   | $R_{thJC}$   | -           | 0.225  | -       | K/W           |               |

**IGBT INVERSE DIODE (D11, D12, D21, D22, D31, D32) CHARACTERISTICS**

|                                       |   |            |   |       |     |     |
|---------------------------------------|---|------------|---|-------|-----|-----|
| Diode Forward Voltage                 | $I_F = 50\text{ A}, T_J = 25^\circ\text{C}$                                     | $V_F$      | - | 1.15  | 1.5 | V   |
|                                       | $I_F = 50\text{ A}, T_J = 175^\circ\text{C}$                                    |            | - | 1.08  | -   |     |
| Thermal Resistance – chip-to-heatsink | Thermal grease,<br>Thickness = 2.1 Mil $\pm 2\%$ , $\lambda = 2.87\text{ W/mK}$ | $R_{thJH}$ | - | 0.956 | -   | K/W |
| Thermal Resistance – chip-to-case     |   | $R_{thJC}$ | - | 0.800 | -   | K/W |

**DIODES (D13, D14, D23, D24, D33, D34) CHARACTERISTICS**

|                                       |  |           |   |         |     |                  |
|---------------------------------------|--|-----------|---|---------|-----|------------------|
| Diode Forward Voltage                 | $I_F = 60\text{ A}, T_J = 25^\circ\text{C}$  | $V_F$     | - | 1.51    | 2.2 | V                |
|                                       | $I_F = 60\text{ A}, T_J = 175^\circ\text{C}$   |           | - | 2.14    | -   |                  |
| Reverse Recovery Time                 | $T_J = 25^\circ\text{C}$<br>$V_{CE} = 600\text{ V}, I_C = 50\text{ A}$<br>$V_{GE} = -9\text{ V}, 15\text{ V}, R_{Gon} = 9\ \Omega$ | $t_{rr}$  | - | 28.14   | -   | ns               |
| Reverse Recovery Charge               |  | $Q_{rr}$  | - | 304.98  | -   | nC               |
| Peak Reverse Recovery Current         |  | $I_{RRM}$ | - | 18.8    | -   | A                |
| Peak Rate of Fall of Recovery Current |  | $di/dt$   | - | 1389.12 | -   | A/ $\mu\text{s}$ |
| Reverse Recovery Energy               |  | $E_{rr}$  | - | 105.08  | -   | $\mu\text{J}$    |
|                                       |  |           | - | -       | -   |                  |

# NXH600B100H4Q2F2S1G, SNXH600B100H4Q2F2S1G-S

**Table 2. ELECTRICAL CHARACTERISTICS** ( $T_J = 25^\circ\text{C}$  unless otherwise noted) (continued)

| Parameter | Test Conditions | Symbol | Min | Typ | Max | Unit |
|-----------|-----------------|--------|-----|-----|-----|------|
|-----------|-----------------|--------|-----|-----|-----|------|

### DIODES (D13, D14, D23, D24, D33, D34) CHARACTERISTICS

|                                       |   |            |   |        |   |                  |
|---------------------------------------|---|------------|---|--------|---|------------------|
| Reverse Recovery Time                 | $T_J = 125^\circ\text{C}$<br>$V_{CE} = 600\text{ V}, I_C = 50\text{ A}$<br>$V_{GE} = -9\text{ V}, 15\text{ V}, R_{Gon} = 9\ \Omega$ | $t_{rr}$   | – | 45.73  | – | ns               |
| Reverse Recovery Charge               |   | $Q_{rr}$   | – | 583.95 | – | nC               |
| Peak Reverse Recovery Current         |   | $I_{RRM}$  | – | 24.08  | – | A                |
| Peak Rate of Fall of Recovery Current |   | $di/dt$    | – | 1236   | – | A/ $\mu\text{s}$ |
| Reverse Recovery Energy               |   | $E_{rr}$   | – | 216.04 | – | $\mu\text{J}$    |
| Thermal Resistance – chip-to-heatsink | Thermal grease,<br>Thickness = 2.1 Mil $\pm 2\%$ , $\lambda = 2.87\text{ W/mK}$   | $R_{thJH}$ | – | 0.599  | – | K/W              |
| Thermal Resistance – chip-to-case     |   | $R_{thJC}$ | – | 0.466  | – | K/W              |

### START-UP DIODE (D15, D25, D35) CHARACTERISTICS

|                                       |   |            |   |       |     |     |
|---------------------------------------|---|------------|---|-------|-----|-----|
| Diode Forward Voltage                 | $I_F = 30\text{ A}, T_J = 25^\circ\text{C}$                                     | $V_F$      | – | 2.25  | 3.2 | V   |
|                                       | $I_F = 30\text{ A}, T_J = 175^\circ\text{C}$                                    |            | – | 1.8   | –   |     |
| Thermal Resistance – chip-to-heatsink | Thermal grease,<br>Thickness = 2.1 Mil $\pm 2\%$ , $\lambda = 2.87\text{ W/mK}$ | $R_{thJH}$ | – | 1.309 | –   | K/W |
| Thermal Resistance – chip-to-case     |   | $R_{thJC}$ | – | 1.133 | –   | K/W |

### THERMISTOR CHARACTERISTICS

|                            |                                  |              |    |       |   |            |
|----------------------------|----------------------------------|--------------|----|-------|---|------------|
| Nominal resistance         | $T = 25^\circ\text{C}$           | $R_{25}$     | –  | 5     | – | k $\Omega$ |
| Nominal resistance         | $T = 100^\circ\text{C}$          | $R_{100}$    | –  | 490.6 | – | $\Omega$   |
| Deviation of R25           |                                  | $\Delta R/R$ | –1 | –     | 1 | %          |
| Power dissipation          |                                  | $P_D$        | –  | 5     | – | mW         |
| Power dissipation constant |                                  |              | –  | 1.3   | – | mW/K       |
| B-value                    | $B(25/85)$ , tolerance $\pm 1\%$ |              | –  | 3435  | – | K          |

Product parametric performance is indicated in the Electrical Characteristics for the listed test conditions, unless otherwise noted. Product performance may not be indicated by the Electrical Characteristics if operated under different conditions.

### ORDERING INFORMATION

| Orderable Part Number  | Marking                | Package  | Shipping                |
|------------------------|------------------------|--|-------------------------|
| NXH600B100H4Q2F2S1G    | NXH600B100H4Q2F2S1G    | Q2BOOST, Case 180BK<br>(Pb-Free and Halide-Free Solder Pins) | 12 Units / Blister Tray |
| SNXH600B100H4Q2F2S1G-S | SNXH600B100H4Q2F2S1G-S | Q2BOOST, Case 180BK<br>(Pb-Free and Halide-Free Solder Pins) | 12 Units / Blister Tray |

# NXH600B100H4Q2F2S1G, SNXH600B100H4Q2F2S1G-S

## TYPICAL CHARACTERISTICS - T11||D13, T12||D14, T21||D23, T22||D24, T31||D33, T32||D34

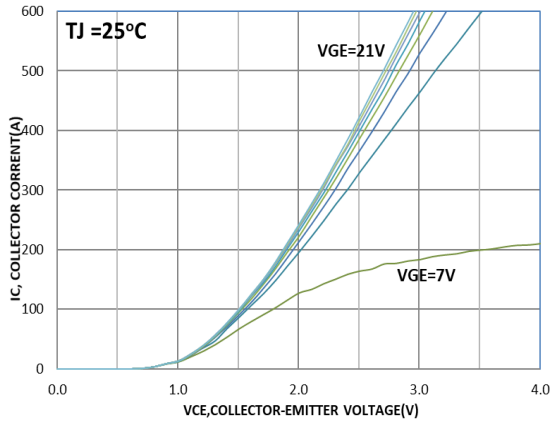


Figure 2. Typical Output Characteristics

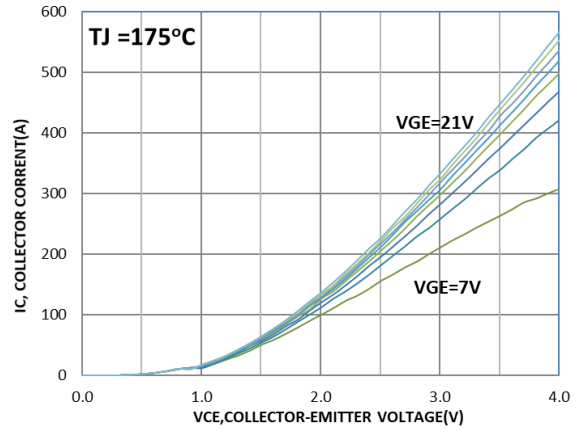


Figure 3. Typical Output Characteristics

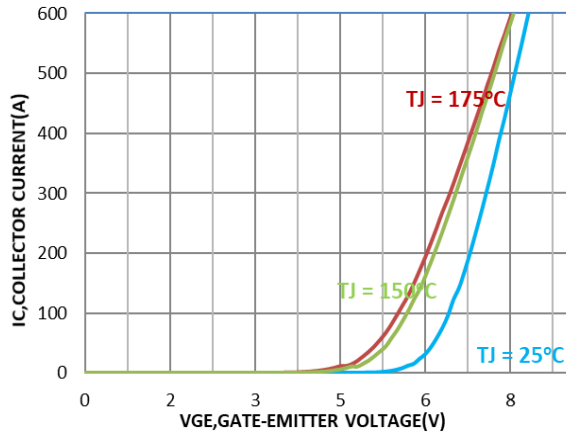


Figure 4. Transfer Characteristics

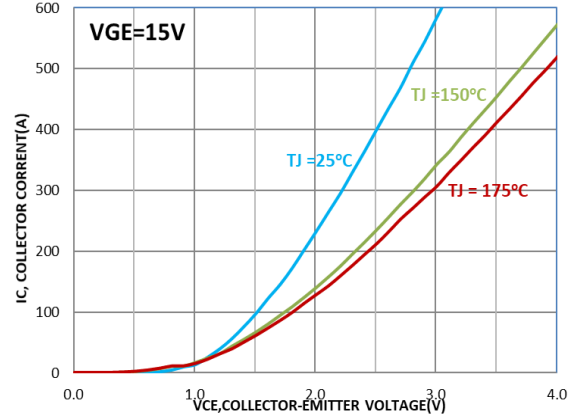


Figure 5. Saturation Voltage Characteristic

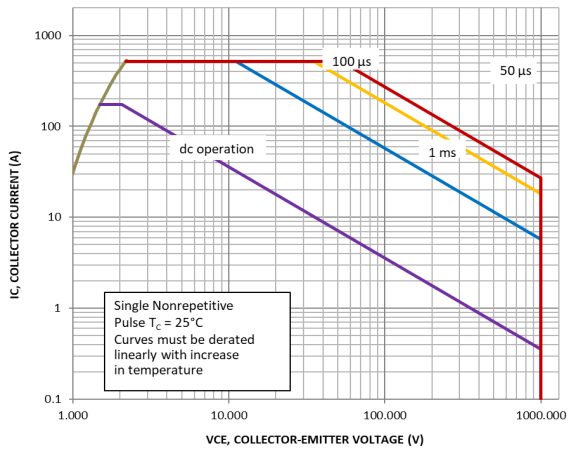


Figure 6. FBSOA

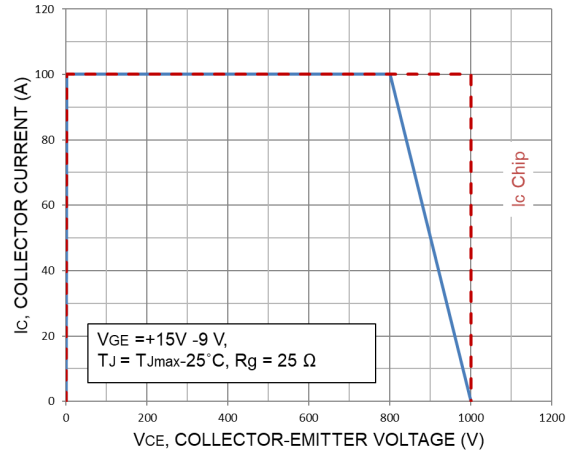
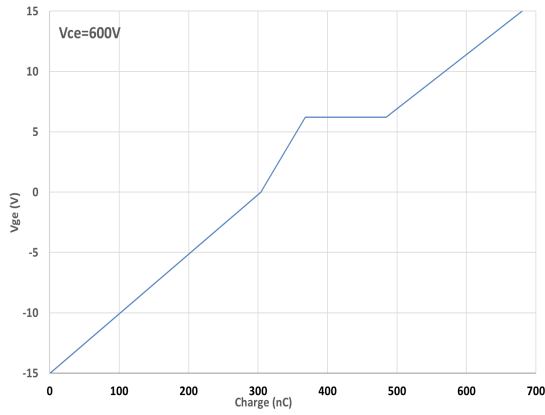


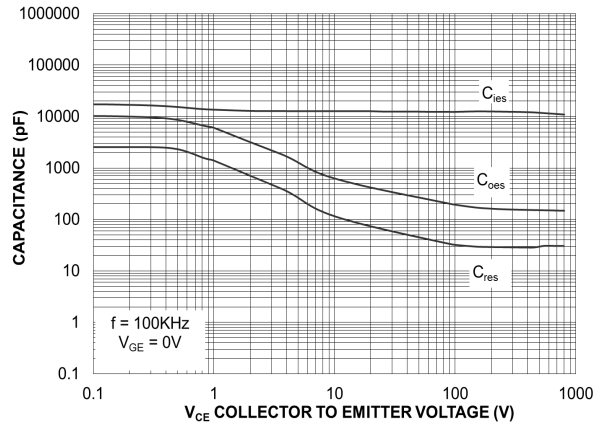
Figure 7. RBSOA

# NXH600B100H4Q2F2S1G, SNXH600B100H4Q2F2S1G-S

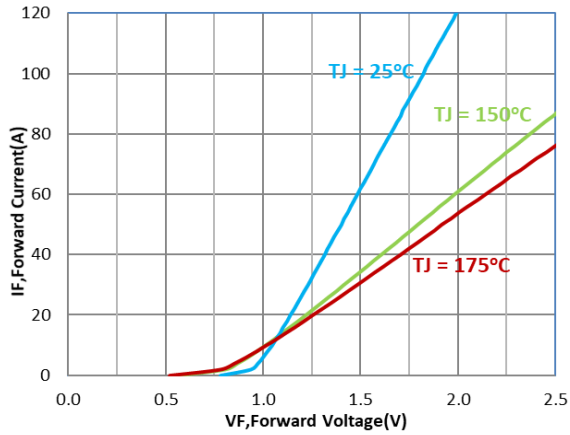
## TYPICAL CHARACTERISTICS – T11||D13, T12||D14, T21||D23, T22||D24, T31||D33, T32||D34 (CONTINUED)



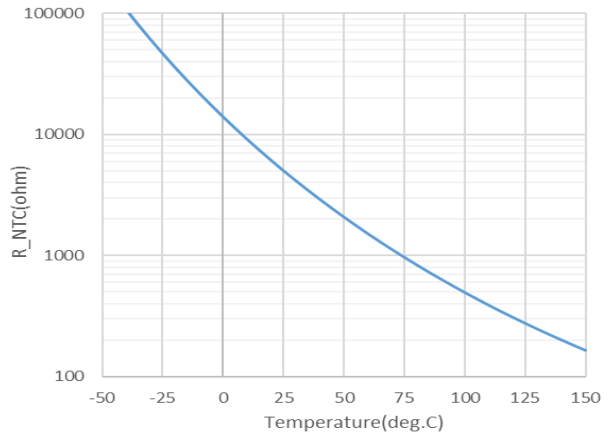
**Figure 8. Gate Voltage vs. Gate Charge**



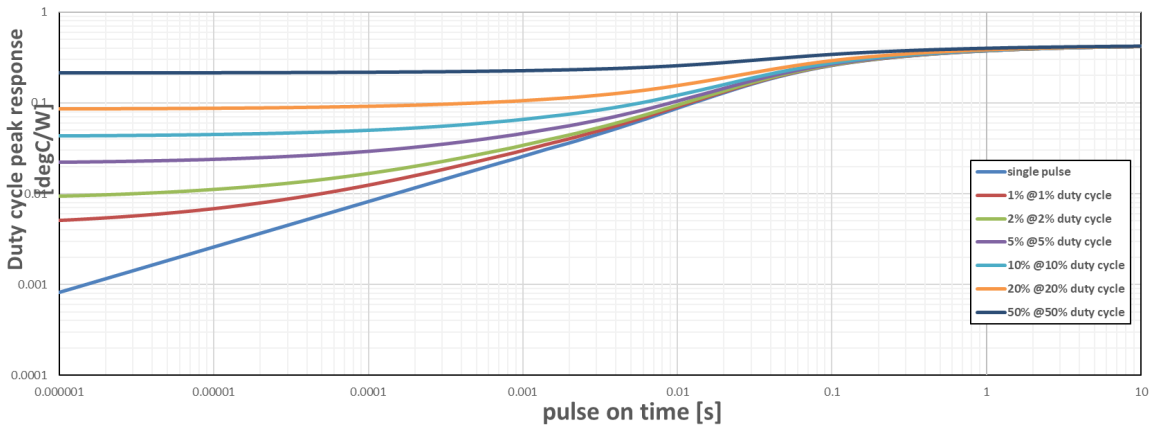
**Figure 9. Capacitance**



**Figure 10. Diode Forward Characteristics**



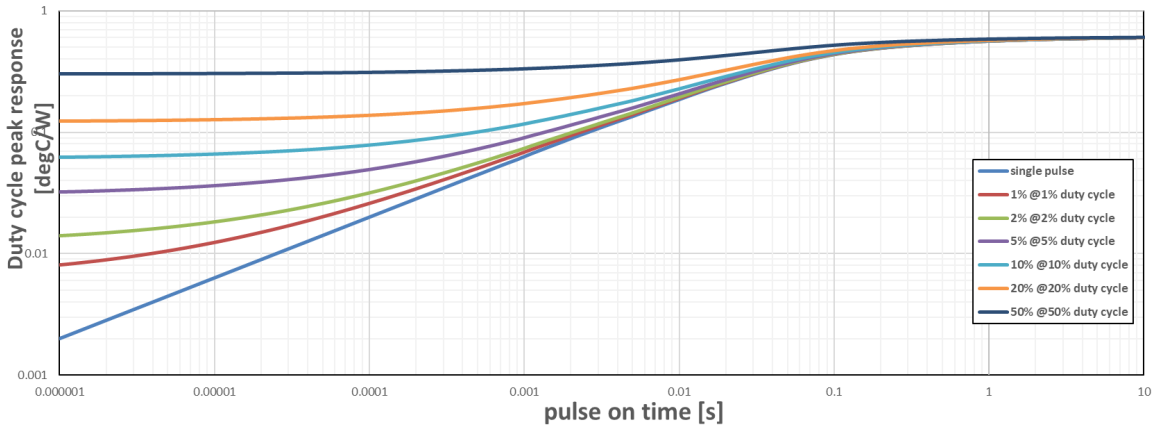
**Figure 11. Temperature vs. NTC Value**



**Figure 12. Transient Thermal Impedance (IGBT Rthjc)**

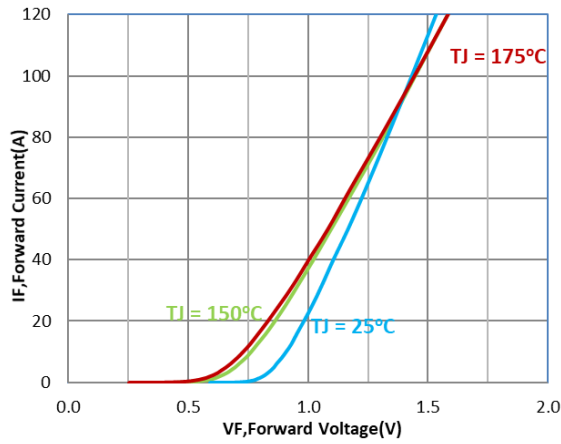
# NXH600B100H4Q2F2S1G, SNXH600B100H4Q2F2S1G-S

## TYPICAL CHARACTERISTICS – T11||D13, T12||D14, T21||D23, T22||D24, T31||D33, T32||D34 (CONTINUED)

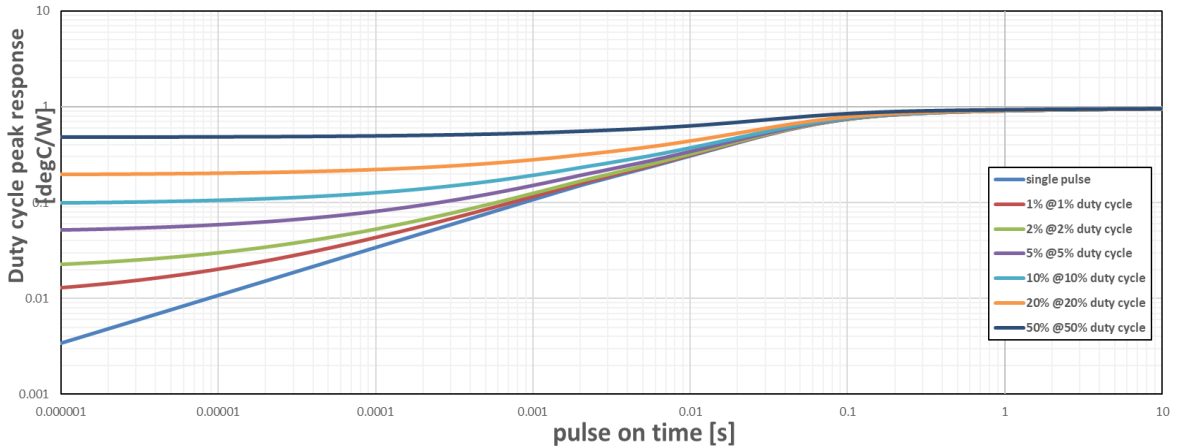


**Figure 13. Transient Thermal Impedance (DIODE Rthjc)**

## TYPICAL CHARACTERISTICS – D11, D12, D21, D22, D31, D32 DIODE



**Figure 14. Diode Forward Characteristics**



**Figure 15. Transient Thermal Impedance (Rthjc)**

TYPICAL CHARACTERISTICS – D15, D25, D35 DIODE

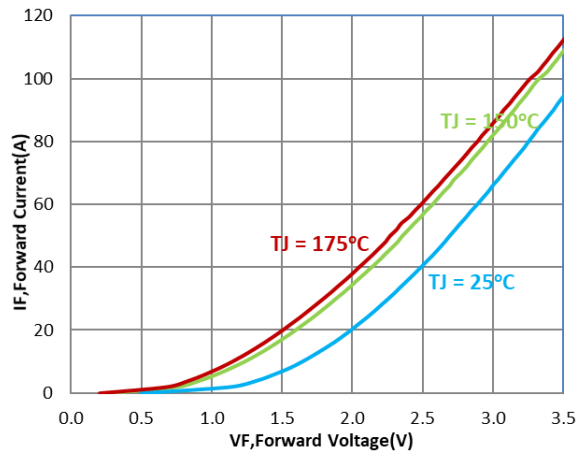


Figure 16. Diode Forward Characteristics

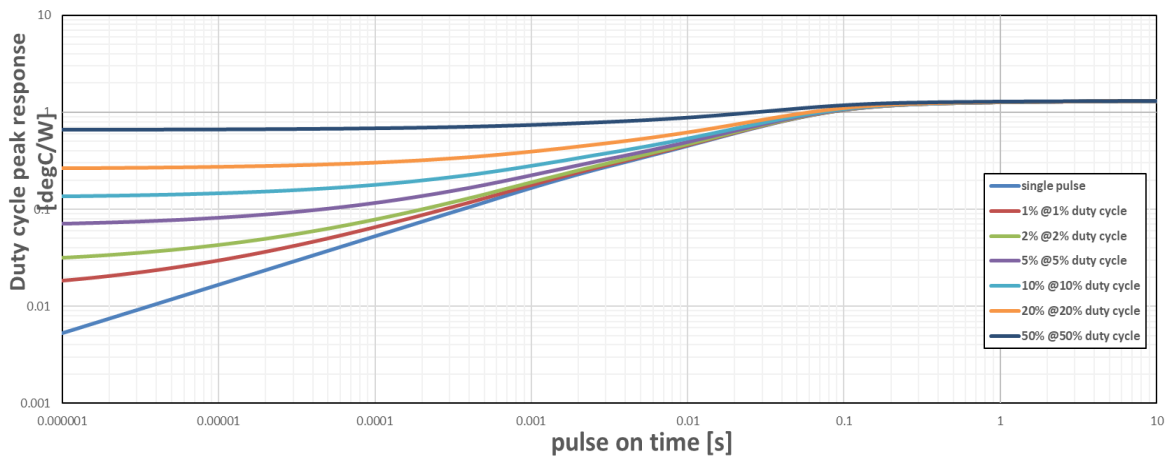


Figure 17. Transient Thermal Impedance (Rthjc)



# NXH600B100H4Q2F2S1G, SNXH600B100H4Q2F2S1G-S

## TYPICAL CHARACTERISTICS – T11||D13, T12||D14, T21||D23, T22||D24, T31||D33, T32||D34

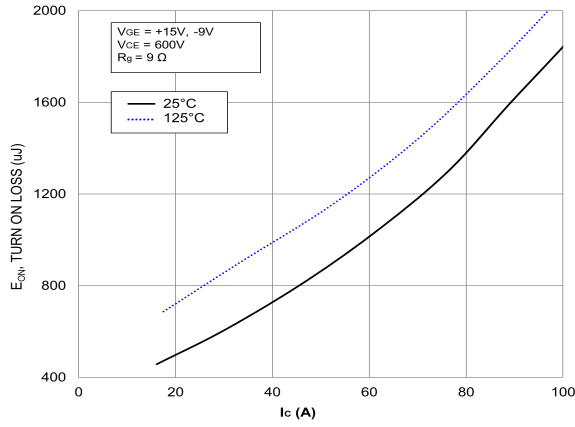


Figure 18. Typical Turn On Loss vs.  $I_C$

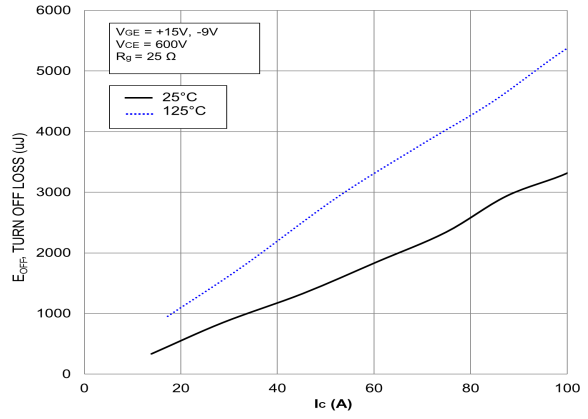


Figure 19. Typical Turn Off Loss vs.  $I_C$

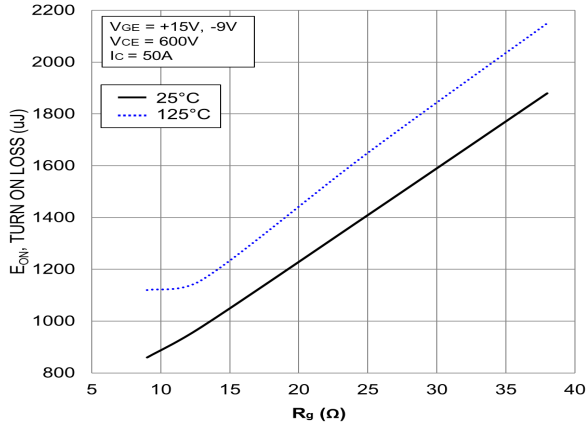


Figure 20. Typical Turn On Loss vs.  $R_G$

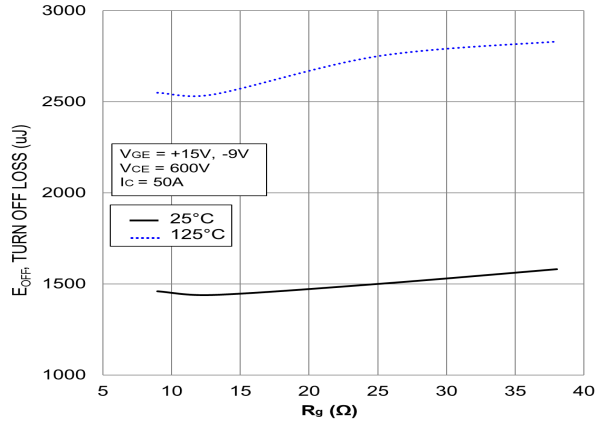


Figure 21. Typical Turn Off Loss vs.  $R_G$

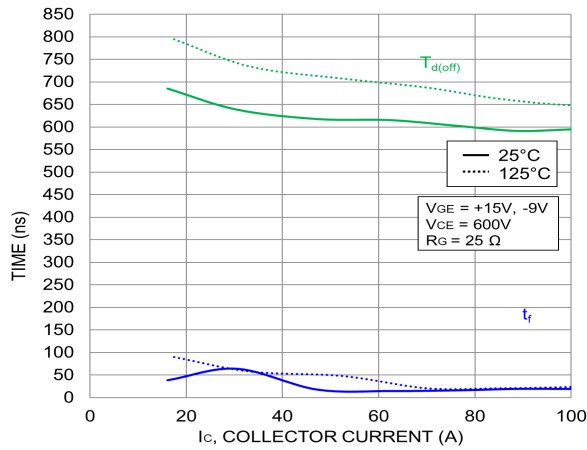


Figure 22. Typical Turn-Off Switching Time vs.  $I_C$

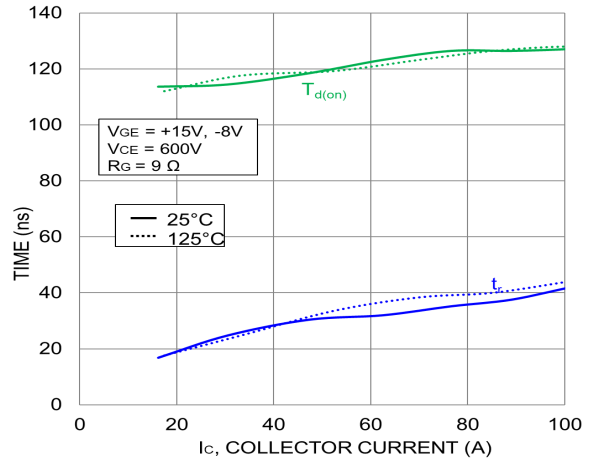
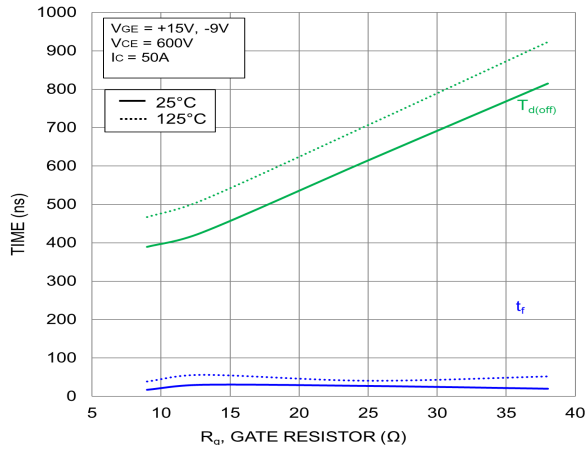


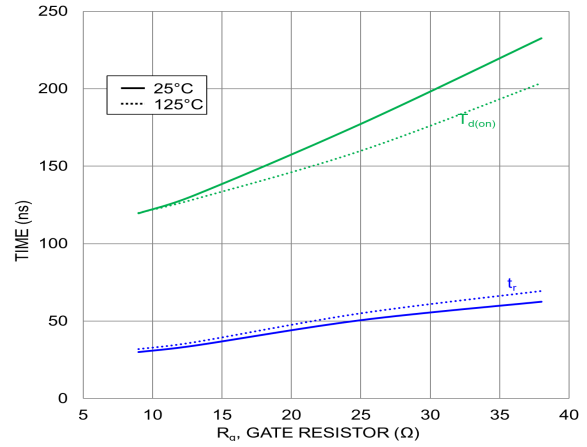
Figure 23. Typical Turn-On Switching Time vs.  $I_C$

# NXH600B100H4Q2F2S1G, SNXH600B100H4Q2F2S1G-S

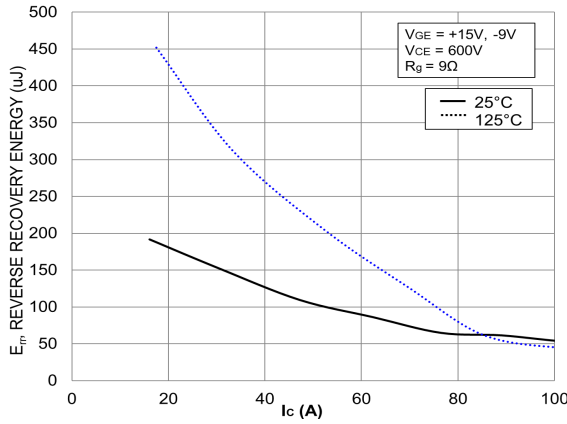
## TYPICAL CHARACTERISTICS – T11||D13, T12||D14, T21||D23, T22||D24, T31||D33, T32||D34 (continued)



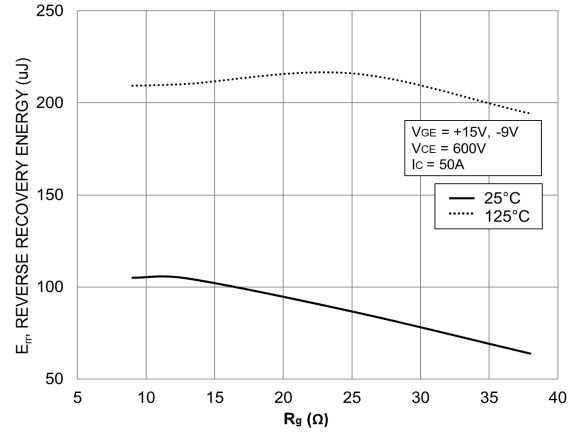
**Figure 24. Typical Turn-Off Switching Time vs.  $R_g$**



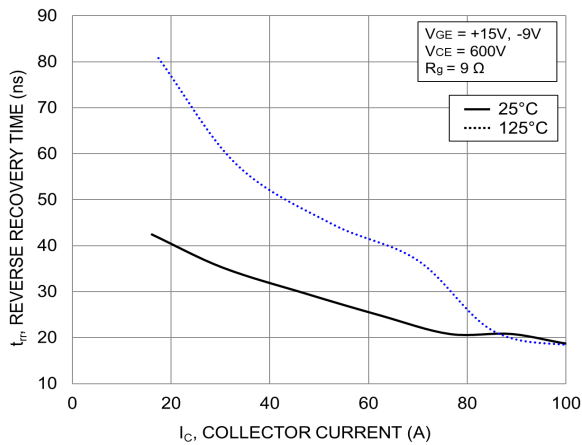
**Figure 25. Typical Turn-On Switching Time vs.  $R_g$**



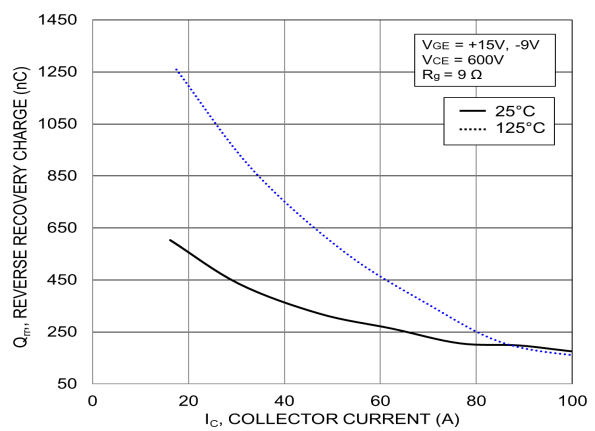
**Figure 26. Typical Reverse Recovery Energy Loss vs.  $I_C$**



**Figure 27. Typical Reverse Recovery Energy Loss vs.  $R_g$**



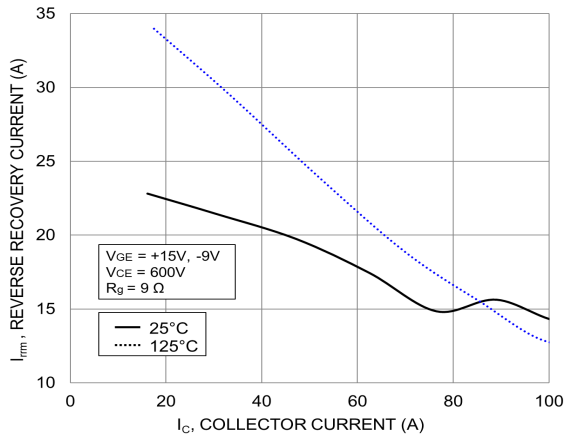
**Figure 28. Typical Reverse Recovery Time vs.  $I_C$**



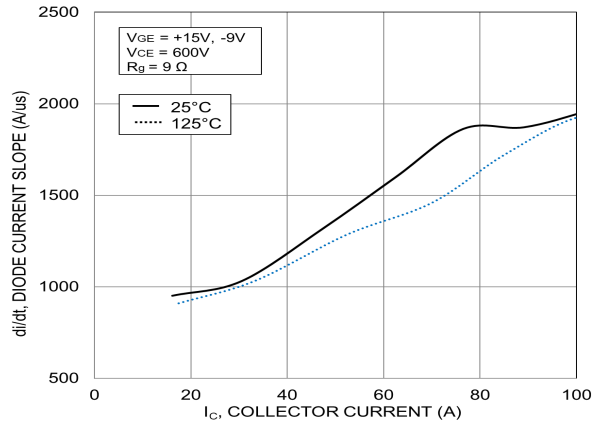
**Figure 29. Typical Reverse Recovery Charge vs.  $I_C$**

# NXH600B100H4Q2F2S1G, SNXH600B100H4Q2F2S1G-S

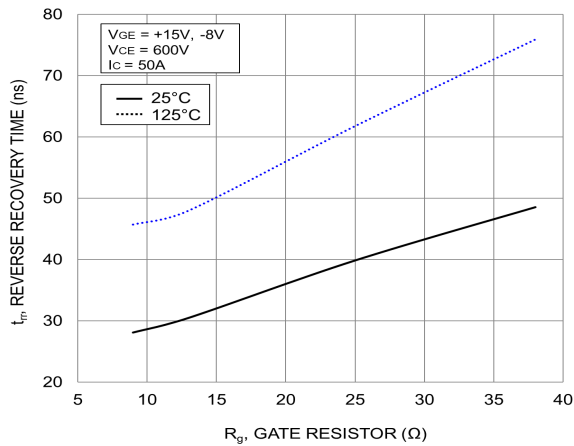
TYPICAL CHARACTERISTICS – T11||D13, T12||D14, T21||D23, T22||D24, T31||D33, T32||D34 (continued)



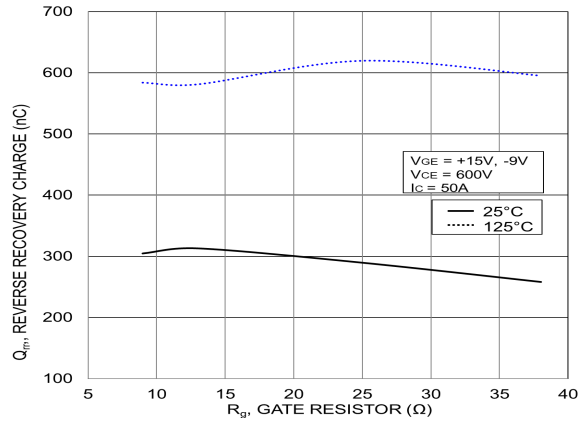
**Figure 30. Typical Reverse Recovery Current vs.  $I_C$**



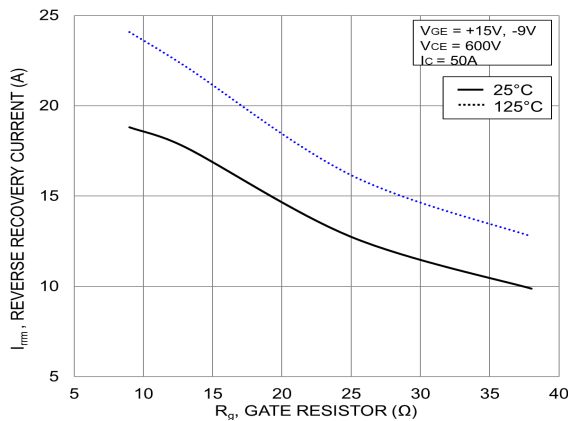
**Figure 31. Typical di/dt vs.  $I_C$**



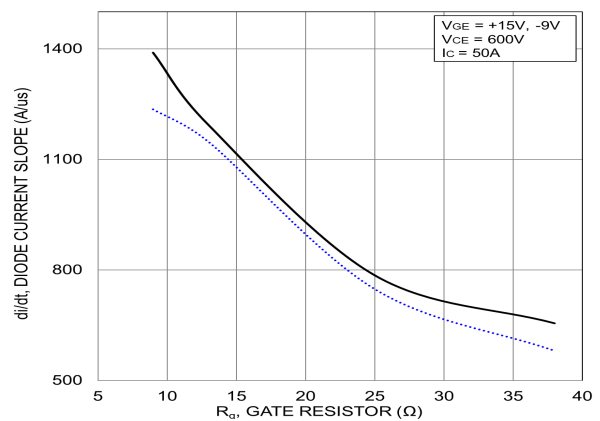
**Figure 32. Typical Reverse Recovery Time vs.  $R_g$**



**Figure 33. Typical Reverse Recovery Charge vs.  $R_g$**

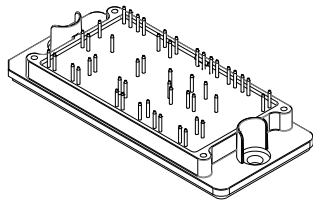


**Figure 34. Typical Reverse Recovery Peak Current vs.  $R_g$**



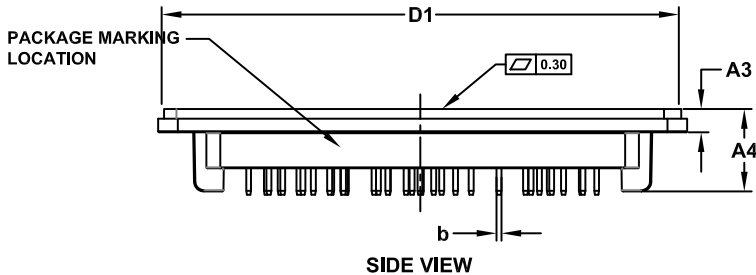
**Figure 35. Typical di/dt vs.  $R_g$**

EliteSiC is a trademark of Semiconductor Components Industries, LLC dba "onsemi" or its affiliates and/or subsidiaries in the United States and/or other countries.



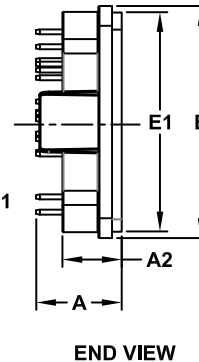
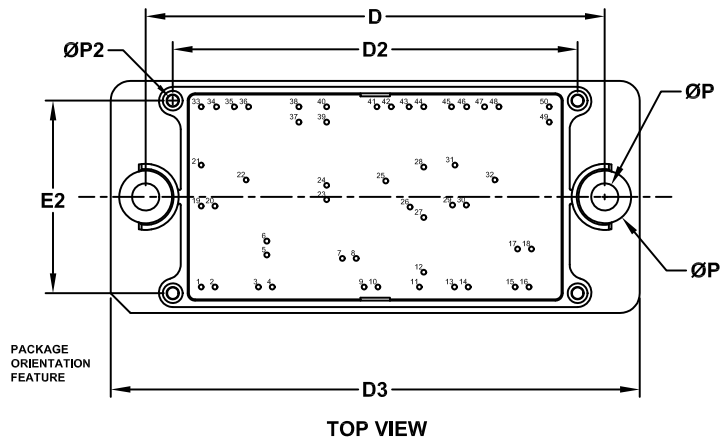
PIM56, 93x47 (SOLDER PIN)  
CASE 180BK  
ISSUE O

DATE 19 MAY 2022



NOTES:

1. DIMENSIONING AND TOLERANCING PER ASME Y14.5M, 2009
2. CONTROLLING DIMENSION : MILLIMETERS
3. DIMENSIONS b AND b1 APPLY TO THE PLATED TERMINALS AND ARE MEASURED AT DIMENSION A1
4. PIN POSITION TOLERANCE IS  $\pm 0.4\text{mm}$
5. PACKAGE MARKING IS LOCATED AS SHOWN ON THE SIDE OPPOSITE THE PACKAGE ORIENTATION FEATURES



| DIM | MILLIMETERS |        |        |
|-----|-------------|--------|--------|
|     | MIN.        | NOM.   | MAX.   |
| A   | 16.80       | 17.20  | 17.60  |
| A2  | 11.70       | 12.00  | 12.30  |
| A3  | 4.40        | 4.70   | 5.00   |
| A4  | 16.40       | 16.70  | 17.00  |
| b   | 0.95        | 1.00   | 1.05   |
| D   | 92.90       | 93.00  | 93.10  |
| D1  | 104.45      | 104.75 | 105.05 |
| D2  | 81.80       | 82.00  | 82.20  |
| D3  | 106.90      | 107.20 | 107.50 |
| E   | 46.70       | 47.00  | 47.30  |
| E1  | 44.10       | 44.40  | 44.70  |
| E2  | 38.80       | 39.00  | 39.20  |
| P   | 5.40        | 5.50   | 5.60   |
| P1  | 10.60       | 10.70  | 10.80  |
| P2  | 1.80        | 2.00   | 2.20   |

NOTE 4

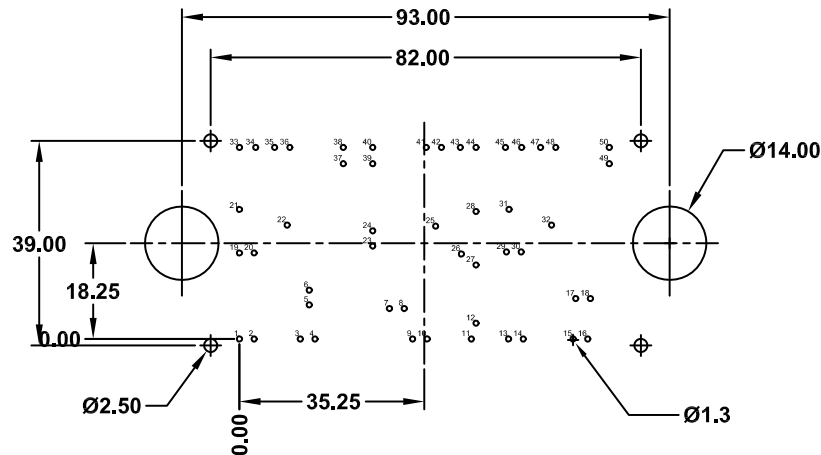
| Pin # | X    | Y    | Function | Pin # | X    | Y    | Function |
|-------|------|------|----------|-------|------|------|----------|
| 1     | 0    | 0    | BSC12    | 26    | 42.3 | 16.2 | G21      |
| 2     | 2.8  | 0    | BSC12    | 27    | 45.1 | 14.1 | E21      |
| 3     | 11.6 | 0    | BSC11    | 28    | 45.1 | 24.3 | N2       |
| 4     | 14.4 | 0    | BSC11    | 29    | 50.9 | 16.6 | E31      |
| 5     | 13.3 | 6.5  | BST1     | 30    | 53.7 | 16.6 | G31      |
| 6     | 13.3 | 9.3  | BST1     | 31    | 51.4 | 24.7 | N3       |
| 7     | 28.6 | 5.8  | BST2     | 32    | 59.5 | 21.7 | C32      |
| 8     | 31.4 | 5.8  | BST2     | 33    | 0    | 36.5 | DC-1     |
| 9     | 33   | 0    | BSC21    | 34    | 3.1  | 36.5 | DC-1     |
| 10    | 35.8 | 0    | BSC21    | 35    | 6.7  | 36.5 | E12      |
| 11    | 44.2 | 0    | BSC22    | 36    | 9.6  | 36.5 | G12      |
| 12    | 45.1 | 3    | BSC22    | 37    | 19.8 | 33.4 | DC+1     |
| 13    | 51.3 | 0    | BSC32    | 38    | 19.8 | 36.5 | DC+1     |
| 14    | 54.1 | 0    | BSC32    | 39    | 25.4 | 33.4 | DC+2     |
| 15    | 63.6 | 0    | BSC31    | 40    | 25.4 | 36.5 | DC+2     |
| 16    | 66.4 | 0    | BSC31    | 41    | 35.6 | 36.5 | G22      |
| 17    | 64.1 | 7.7  | BST3     | 42    | 38.5 | 36.5 | E22      |
| 18    | 66.9 | 7.7  | BST3     | 43    | 42.1 | 36.5 | DC-2     |
| 19    | 0    | 16.4 | E11      | 44    | 45.1 | 36.5 | DC-2     |
| 20    | 2.8  | 16.4 | G11      | 45    | 50.7 | 36.5 | DC-3     |
| 21    | 0    | 24.7 | N1       | 46    | 53.8 | 36.5 | DC-3     |
| 22    | 9.1  | 21.7 | C12      | 47    | 57.4 | 36.5 | E32      |
| 23    | 25.4 | 17.7 | TH2      | 48    | 60.3 | 36.5 | G32      |
| 24    | 25.4 | 20.6 | TH1      | 49    | 70.5 | 33.4 | DC+3     |
| 25    | 37.4 | 21.5 | C22      | 50    | 70.5 | 36.5 | DC+3     |

|                         |                                  |   |
|-------------------------|----------------------------------|---|
| <b>DOCUMENT NUMBER:</b> | <b>98AON45176H</b>               | Electronic versions are uncontrolled except when accessed directly from the Document Repository.<br>Printed versions are uncontrolled except when stamped "CONTROLLED COPY" in red. |
| <b>DESCRIPTION:</b>     | <b>PIM56, 93x47 (SOLDER PIN)</b> | <b>PAGE 1 OF 2</b>  |

onsemi and ONSEMI are trademarks of Semiconductor Components Industries, LLC dba onsemi or its subsidiaries in the United States and/or other countries. onsemi reserves the right to make changes without further notice to any products herein. onsemi makes no warranty, representation or guarantee regarding the suitability of its products for any particular purpose, nor does onsemi assume any liability arising out of the application or use of any product or circuit, and specifically disclaims any and all liability, including without limitation special, consequential or incidental damages. onsemi does not convey any license under its patent rights nor the rights of others.

**PIM56, 93x47 (SOLDER PIN)**  
CASE 180BK  
ISSUE O

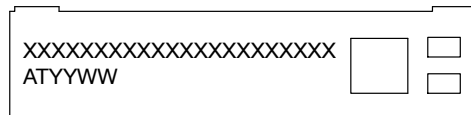
DATE 19 MAY 2022



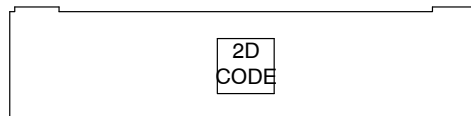
**RECOMMENDED MOUNTING PATTERN**

\* For additional information on our Pb-Free strategy and soldering details, please download the ON Semiconductor Soldering and Mounting Techniques Reference Manual, SOLDERRM/D.

**GENERIC MARKING DIAGRAM\***



FRONTSIDE MARKING



BACKSIDE MARKING

XXXXX = Specific Device Code  
AT = Assembly & Test Site Code  
YYWW = Year and Work Week Code

\*This information is generic. Please refer to device data sheet for actual part marking. Pb-Free indicator, "G" or microdot "•", may or may not be present. Some products may not follow the Generic Marking.

|                         |                                  |  |
|-------------------------|----------------------------------|--|
| <b>DOCUMENT NUMBER:</b> | <b>98AON45176H</b>               | Electronic versions are uncontrolled except when accessed directly from the Document Repository. Printed versions are uncontrolled except when stamped "CONTROLLED COPY" in red. |
| <b>DESCRIPTION:</b>     | <b>PIM56, 93x47 (SOLDER PIN)</b> | <b>PAGE 2 OF 2</b>   |

onsemi and ONSEMI are trademarks of Semiconductor Components Industries, LLC dba onsemi or its subsidiaries in the United States and/or other countries. onsemi reserves the right to make changes without further notice to any products herein. onsemi makes no warranty, representation or guarantee regarding the suitability of its products for any particular purpose, nor does onsemi assume any liability arising out of the application or use of any product or circuit, and specifically disclaims any and all liability, including without limitation special, consequential or incidental damages. onsemi does not convey any license under its patent rights nor the rights of others.

**onsemi**, **Onsemi**, and other names, marks, and brands are registered and/or common law trademarks of Semiconductor Components Industries, LLC dba "**onsemi**" or its affiliates and/or subsidiaries in the United States and/or other countries. **onsemi** owns the rights to a number of patents, trademarks, copyrights, trade secrets, and other intellectual property. A listing of **onsemi**'s product/patent coverage may be accessed at [www.onsemi.com/site/pdf/Patent-Marking.pdf](http://www.onsemi.com/site/pdf/Patent-Marking.pdf). **onsemi** reserves the right to make changes at any time to any products or information herein, without notice. The information herein is provided "as-is" and **onsemi** makes no warranty, representation or guarantee regarding the accuracy of the information, product features, availability, functionality, or suitability of its products for any particular purpose, nor does **onsemi** assume any liability arising out of the application or use of any product or circuit, and specifically disclaims any and all liability, including without limitation special, consequential or incidental damages. Buyer is responsible for its products and applications using **onsemi** products, including compliance with all laws, regulations and safety requirements or standards, regardless of any support or applications information provided by **onsemi**. "Typical" parameters which may be provided in **onsemi** data sheets and/or specifications can and do vary in different applications and actual performance may vary over time. All operating parameters, including "Typicals" must be validated for each customer application by customer's technical experts. **onsemi** does not convey any license under any of its intellectual property rights nor the rights of others. **onsemi** products are not designed, intended, or authorized for use as a critical component in life support systems or any FDA Class 3 medical devices or medical devices with a same or similar classification in a foreign jurisdiction or any devices intended for implantation in the human body. Should Buyer purchase or use **onsemi** products for any such unintended or unauthorized application, Buyer shall indemnify and hold **onsemi** and its officers, employees, subsidiaries, affiliates, and distributors harmless against all claims, costs, damages, and expenses, and reasonable attorney fees arising out of, directly or indirectly, any claim of personal injury or death associated with such unintended or unauthorized use, even if such claim alleges that **onsemi** was negligent regarding the design or manufacture of the part. **onsemi** is an Equal Opportunity/Affirmative Action Employer. This literature is subject to all applicable copyright laws and is not for resale in any manner.

## ADDITIONAL INFORMATION

### TECHNICAL PUBLICATIONS:

Technical Library: [www.onsemi.com/design/resources/technical-documentation](http://www.onsemi.com/design/resources/technical-documentation)  
onsemi Website: [www.onsemi.com](http://www.onsemi.com)

### ONLINE SUPPORT: [www.onsemi.com/support](http://www.onsemi.com/support)

For additional information, please contact your local Sales Representative at [www.onsemi.com/support/sales](http://www.onsemi.com/support/sales)