

Automotive Power MOSFET Module

NXV08H250DPT2

Features

- 2 Phase MOSFET Module
 At Customer Side this Module Can Be Used as 1/2 Bridge MOSFET Module by Combining 2 Phase Out Power Terminals
- Electrically Isolated DBC Substrate for Low Rthjc
- Compact Design for Low Total Module Resistance
- Module Serialization for Full Traceability
- Automotive Qualified by AQC324 Qualification
- UL 94 V-0 Compliant
- This Device is Pb-Free and is RoHS Compliant

Applications

- 48 V Inverter, 48 V Traction

Benefits

- Enable Design of Small, Efficient and Reliable System for Reduced Vehicle Fuel Consumption and CO₂ Emission
- Simplified Vehicle Assembly
- Low Thermal Resistance to Junction to Heat Sink by Direct Mounting via Thermal Interface Material between Module Case and Heat Sink
- Low Inductance

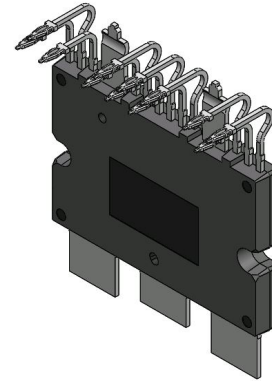

APM17-MFA
 CASE MODBM

MARKING DIAGRAM

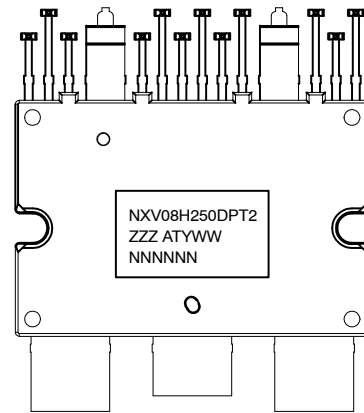

NXV08H250DPT2 = Specific Device Code
 ZZZ = Lot ID
 AT = Assembly & Test Location
 Y = Year
 WW = Work Week
 NNN = Serial Number

ORDERING INFORMATION

See detailed ordering and shipping information on page 2 of this data sheet.

NXV08H250DPT2

ORDERING INFORMATION

Part Number	Package	Pb-Free and RoHS Compliant	Operating Ambient Temperature Range	Packing Method
NXV08H250DPT2	APM17-MFA	yes	-40~125°C	Tube

Pin Configuration

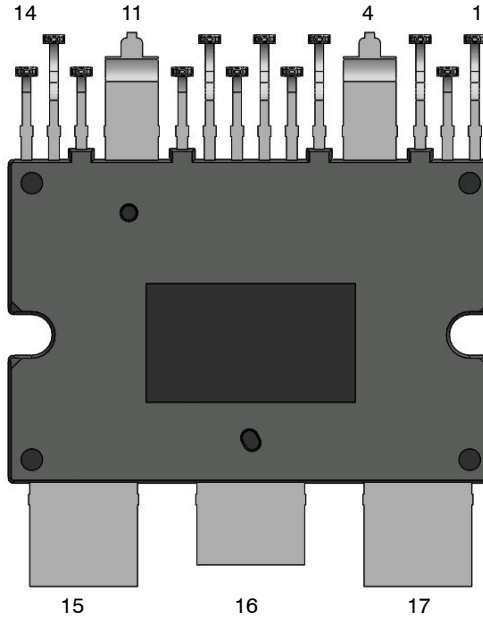

Figure 1. Pin Configuration

PIN DESCRIPTION

Pin No.	Description	Remark
1	Q2 Gate	
2	Q2 Source Sense	Q2 Source Sense & Q4 Drain
3	B+ #2 Sense	
4	Phase Out 2	
5	Q4 Source Sense	
6	Q4 Gate	
7	NTC1	
8	NTC2	
9	Q3 Gate	
10	Q3 Source Sense	
11	Phase Out 1	
12	B+ #1 Sense	
13	Q1 Source Sense	Q1 Source Sense & Q3 Drain
14	Q1 Gate	
15	B+ #1	
16	GND	Common Ground for B+ #1 and B+ #2
17	B+ #2	

NXV08H250DPT2

Block Diagram

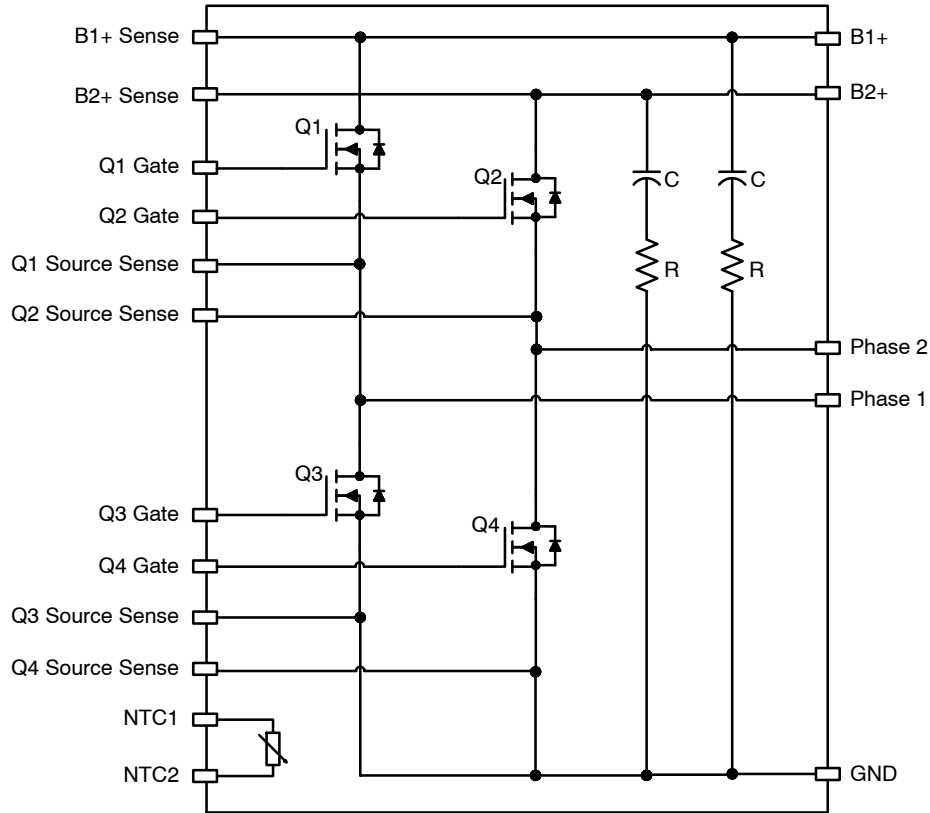

Figure 2. Schematic

Flammability Information

All materials present in the power module meet UL flammability rating class 94V-0.

Compliance to RoHS Directives

The power module is 100% lead free and RoHS compliant 2000/53/C directive.

Solder

Solder used is a lead free SnAgCu alloy.

Base of the leads, at the interface with the package body should not be exposed to more than 200°C during mounting on the PCB, this to prevent the remelt of the solder joints.

ABSOLUTE MAXIMUM RATINGS ($T_J = 25^\circ\text{C}$ unless otherwise specified)

Symbol	Parameter	Max.	Unit
VDS(Q1-Q4)	Drain to Source Voltage	80	V
VGS(Q1-Q4)	Gate to Source Voltage	± 20	V
EAS(Q1-Q4)	Single Pulse Avalanche Energy (Note 1)	1946	mJ
T_J	Maximum Junction Temperature	175	$^\circ\text{C}$
T_{STG}	Storage Temperature	125	$^\circ\text{C}$

Stresses exceeding those listed in the Maximum Ratings table may damage the device. If any of these limits are exceeded, device functionality should not be assumed, damage may occur and reliability may be affected.

1. Starting $T_J = 25^\circ\text{C}$, $L = 0.47\text{ mH}$, $I_{AS} = 91\text{ A}$, $V_{DD} = 72\text{ V}$ during inductor charging and $V_{DD} = 0\text{ V}$ during time in avalanche.

NXV08H250DPT2

ELECTRICAL CHARACTERISTICS (T_J = 25°C, unless otherwise noted)

Characteristic		Condition	Min	Typ	Max	Unit
BVDSS	Drain-to-Source Breakdown Voltage	I _D = 1 mA, V _{GS} = 0 V	80	-	-	
VGS(th)	Gate to Source Threshold Voltage	V _{GS} = V _{DS} , I _D = 1 mA	2	-	4.6	V
VSD	Source-to-Drain Diode Voltage	I _{SD} = 160 A, V _{GS} = 0 V	-	0.79	1.1	V
RDS(ON)Q1, Q2	Q1, Q2 (High Side) MOSFET (Note 2)	V _{GS} = 14 V, I _D = 160 A, T _J = 25°C	-	0.71	0.88	mΩ
RDS(ON) Q3, Q4	Q3, Q4(Low Side) MOSFET (Note 2)	V _{GS} = 14 V, I _D = 160 A, T _J = 25°C	-	0.56	0.71	mΩ
IGSS	Gate-to-Source Leakage Current	V _{GS} = ±20 V, V _{DS} = 0 V, T _J = 25°C	-100	-	+100	nA
IDSS	Drain-to-Source Leakage Current	V _{DS} = 80 V, V _{GS} = 0 V, T _J = 25°C	-	-	2	μA
Module RDS(ON) for Q1 and Q2: From B+1 (or B+2), via Q1 (or Q2), to Phase Out 1 (Phase Out 2) (Note 3)		V _{GS} = 14 V, I _D = 160 A, T _J = 25°C	-	1.01	1.3	mΩ
Module RDS(ON) for Q3 and Q4: From Phase Out 1 (Phase Out 2), via Q3 (Q4), to GND PINs (Note 3)		V _{GS} = 14 V, I _D = 160 A, T _J = 25°C	-	0.98	1.27	mΩ

Product parametric performance is indicated in the Electrical Characteristics for the listed test conditions, unless otherwise noted. Product performance may not be indicated by the Electrical Characteristics if operated under different conditions.

2. All bare die MOSFETs have same die size and same level of R_{ds(on)} value. However the different R_{ds(on)} values listed in the datasheet are due to the different access points available inside the module for R_{ds(on)} measurement. Q3 and Q4 (Low side FETs) has the shortest R_{ds(on)} measurement path in the layout, in this reason, so Q3 or Q4 R_{ds(on)} value can be used for the R_{ds(on)} value per switch for simple power loss calculation.

Each R_{ds(on)} measurement paths are as below table, "Resistance Measurement Methods"

3. Module R_{ds(on)} means total resistance of the measurement path btw Power terminals, referring to the resistance measurement methods table.

RESISTANCE MEASUREMENTS METHODS

	+ Force Pin#	- Force Pin#	+ Sense Pin#	- Sense Pin#
FET R _{ds(on)} Q1	B1+	Phase1	B1+ Sense	Q1 Source Sense
FET R _{ds(on)} Q2	B2+	Phase2	B2+ Sense	Q2 Source Sense
FET R _{ds(on)} Q3	Phase1	GND	Q1 Source Sense	Q3 Source Sense
FET R _{ds(on)} Q4	Phase2	GND	Q2 Source Sense	Q4 Source Sense
Module R _{ds(on)} Q1	B1+	Phase1	B1+	Phase1
Module R _{ds(on)} Q2	B2+	Phase2	B2+	Phase2
Module R _{ds(on)} Q3	Phase1	GND	Phase1	GND
Module R _{ds(on)} Q4	Phase2	GND	Phase2	GND

TEMPERATURE SENSE (NTC THERMISTOR)

Parameter	Min	Typ	Max	Unit
Voltage	7.5	-	12	V

THERMAL RESISTANCE

Parameter	Min	Typ	Max	Unit
R _{th(jc)} : Thermal Resistance Junction to case, Single Inverter FET	-	0.4	0.53	°C/W

ISOLATION VOLTAGE (Isolation voltage between the Base plate and to control pins or power terminals.)

Test	Test Condition	Test Time	Min	Max	Unit
Leakage @ Isolation Voltage (Hi-Pot)	VAC = 3 kV	Time = 1 s	-	250	μA

4. Specifications are temporary and will be updated upon obtaining sufficient characterization and validation data.

NXV08H250DPT2

DYNAMIC AND SWITCHING CHARACTERISTICS (T_J = 25°C unless otherwise noted)

Symbol	Parameter	Condition	Min	Typ	Max	Unit
--------	-----------	-----------	-----	-----	-----	------

DYNAMIC CHARACTERISTICS

C _{iss}	Input Capacitance	V _{DS} = 40 V, V _{GS} = 0 V, f = 750 kHz	–	24350	–	pF
C _{oss}	Output Capacitance		–	3415	–	pF
C _{rss}	Reverse Transfer Capacitance		–	53	–	pF
R _g	Gate Resistance	f = 750 kHz	–	3.6	–	Ω
Q _{g(tot)}	Total Gate Charge	V _{GS} = 0 to 10 V, I _D = 160 A	–	320	–	nC
Q _{gs}	Gate to Source Gate Charge		–	150	–	nC
Q _{gd}	Gate to Drain “Miller” Charge		–	54	–	nC

SWITCHING CHARACTERISTICS

t _{on}	Turn-On Time	V _{DD} = 48 V, I _D = 400 A V _{GS} = 12 V, R _{G(on/off)} = 15/15 Ω	–	462	–	ns
t _{d(on)}	Turn-On Delay Time		–	164	–	ns
t _r	Turn-On Rise Time		–	298	–	ns
t _{d(off)}	Turn-Off Delay Time		–	476	–	ns
t _f	Turn-Off Fall Time		–	196	–	ns
t _{off}	Turn-Off Time		–	672	–	ns

DRAIN-SOURCE DIODE CHARACTERISTICS

Symbol	Parameter	Condition	Min	Typ	Max	Unit
t _{RR}	Reverse Recovery Time	V _{DD} = 48 V, I _D = 400 A V _{GS} = 14 V, R _{G(on/off)} = 3.9/8.2	–	55	–	ns
Q _{RR}	Reverse Recovery Charge		–	2005	–	nC

5. Dynamic & Switching characteristics data is by characterization test result and guaranteed by design factors.

COMPONENTS

Component	Description	Type	Qty.	Specification
MOSFET	Bare Die	Bare Die	4	80 V 0.55 mΩ
NTC	10 kΩ ±1% 1,600 x 800 μm	Discrete	1	B-Constant B25/50 = 3380K B25/85 = 3435K B25/100 = 3455K
Capacitor (Snubber)	1,600 x 800 μm	Discrete	2	47 nF
Resistor (Snubber)	2,000 x 1,200 μm	Discrete	2	1 Ω

NXV08H250DPT2

TYPICAL CHARACTERISTICS

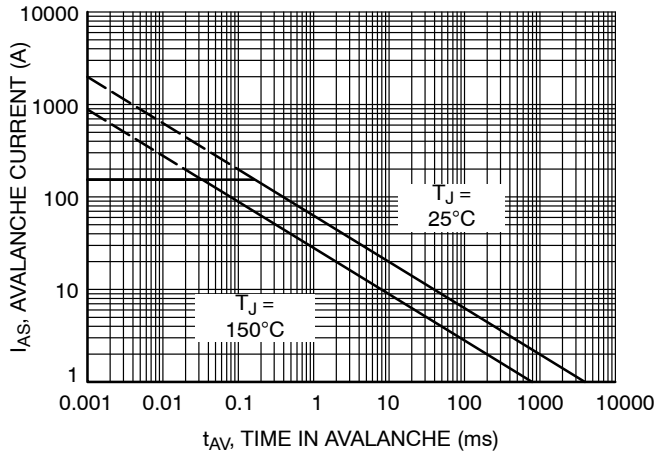

Figure 3. Unclamped Inductive Switching Capability

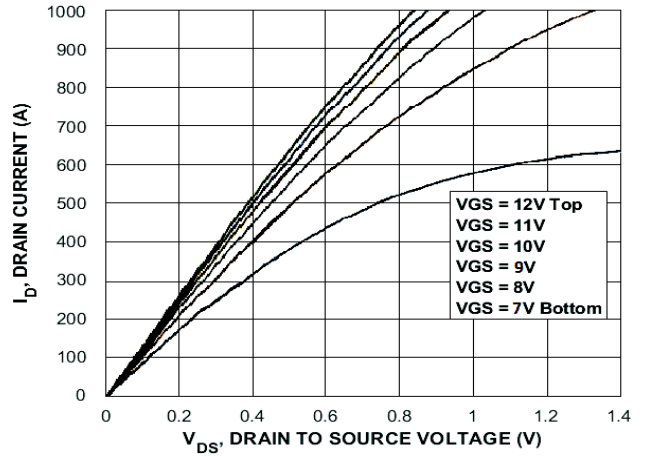

Figure 4. Saturation Characteristics

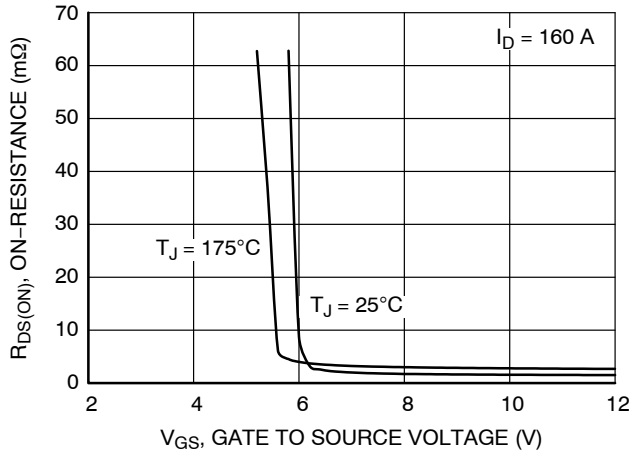

Figure 5. $R_{DS(on)}$ vs. Gate Voltage

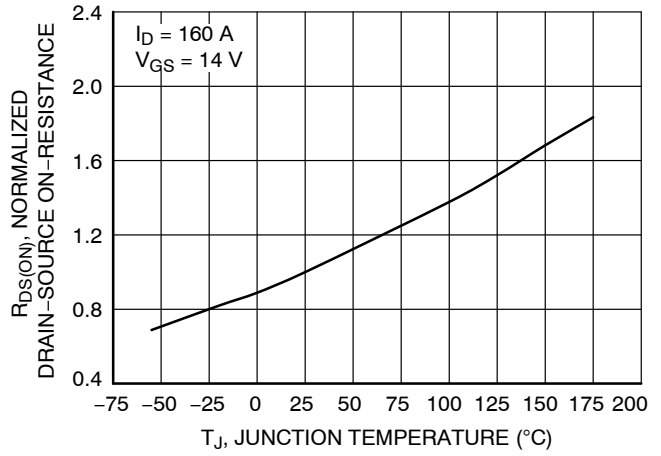

Figure 6. $R_{DS(on)}$ vs. Temperature

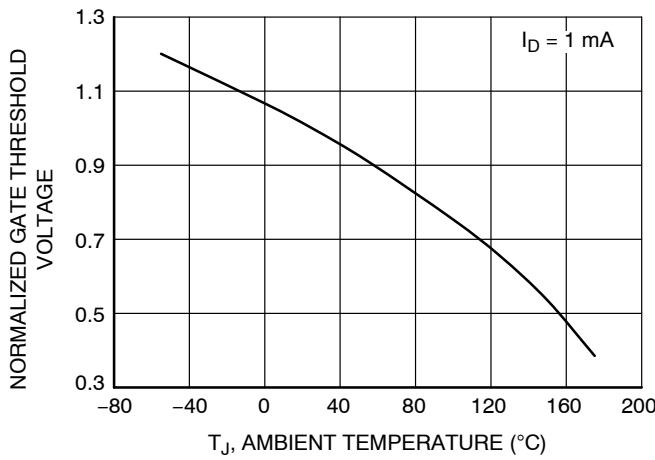

Figure 7. Normalized Gate Threshold Voltage vs. Temperature

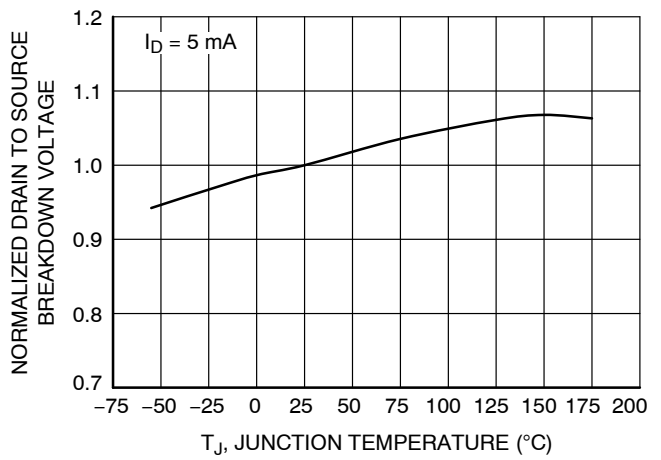

Figure 8. Normalized Drain to Source Breakdown Voltage vs. Junction Temperature

NXV08H250DPT2

TYPICAL CHARACTERISTICS (CONTINUED)

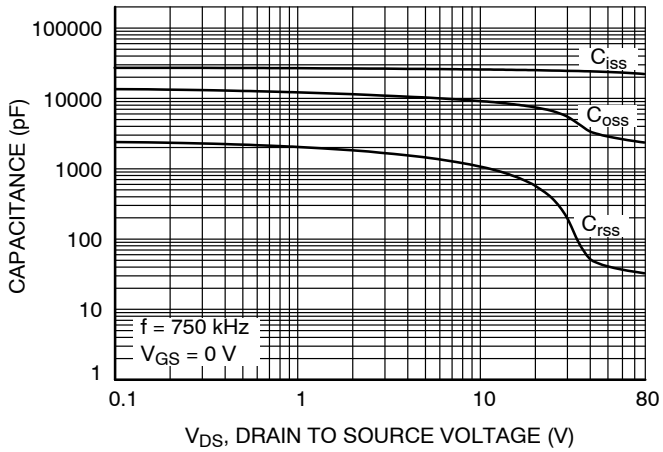

Figure 9. Capacitance vs. Drain to Source Voltage

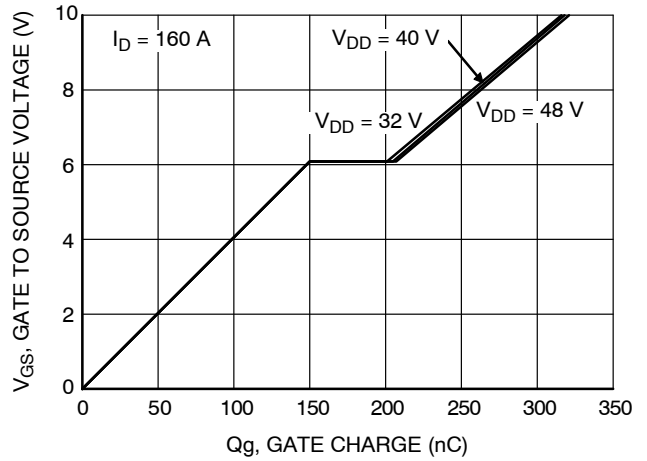

Figure 10. Gate Charge vs. Drain to Source Voltage

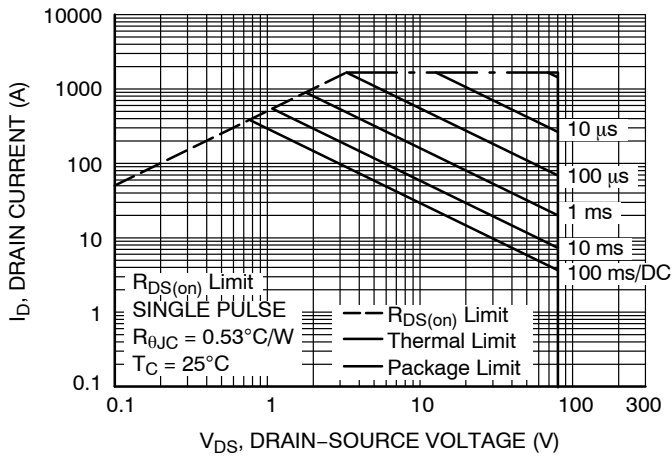

Figure 11. Safe Operating Area

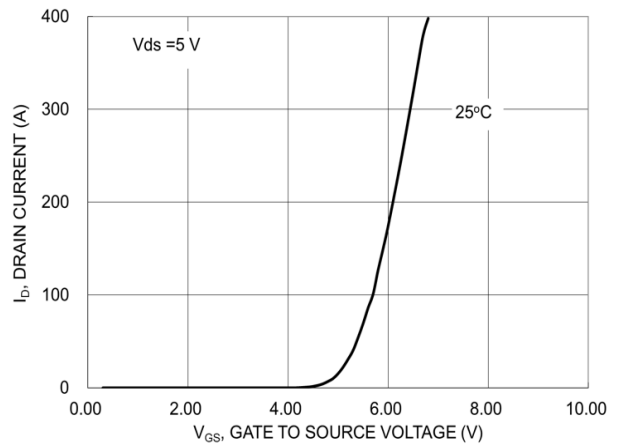

Figure 12. Transfer Characteristics

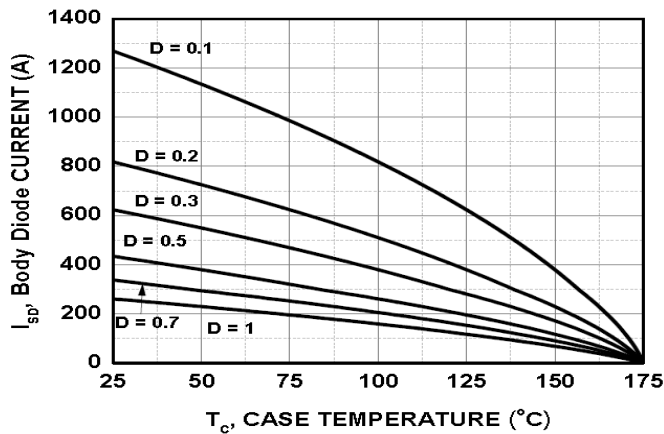
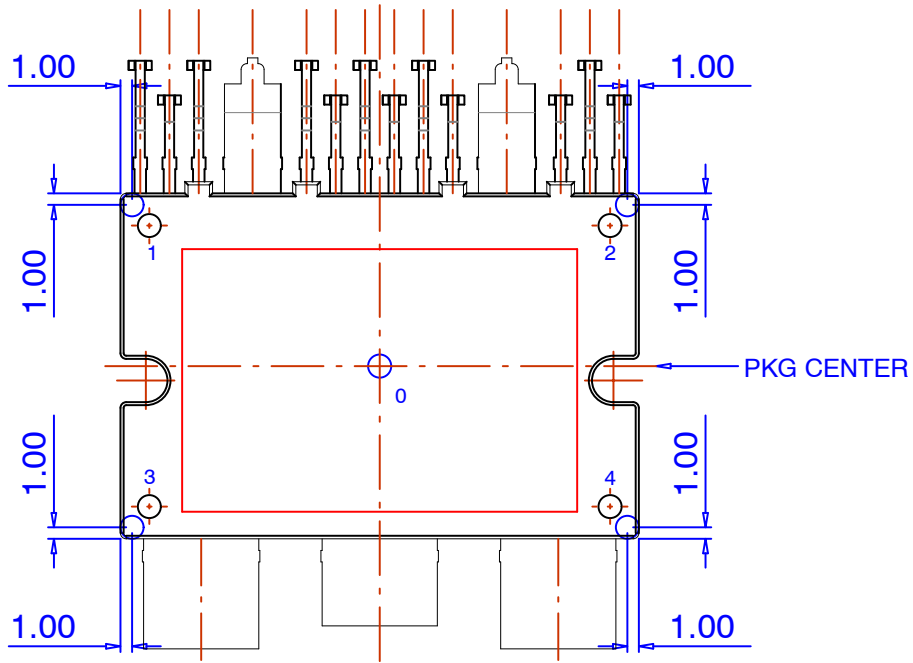

Figure 13. Diode Current Derating

NXV08H250DPT2



FLATNESS : MAX. 150um
-.MEASURING AT INDICATING POINTS
1, 2, 3, AND 4 (BASED ON "0")

Figure 14. Flatness Measurement Position

MECHANICAL CHARACTERISTICS AND RATINGS

Parameter	Test Conditions	Min	Typ	Max	Units
Device Flatness	Refer to the package dimensions	0	-	150	μm
Mounting Torque	Mounting screw: M3 Machine tap screw, recommended 0.7 N•m	0.4	-	1.4 (Note 6)	N•m
Weight		-	22.2	-	g

6. Max Torque rating can be different by the type of screw, such as the screw head diameter, use or without use of Washer. In case of special screw mounting method is applied, contact to **onsemi** for the proper information of mounding condition.

MECHANICAL CASE OUTLINE PACKAGE DIMENSIONS

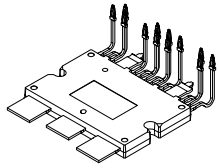

APM17-MFA, AUTOMOTIVE MODULE CASE MODBM ISSUE A

DATE 12 OCT 2022

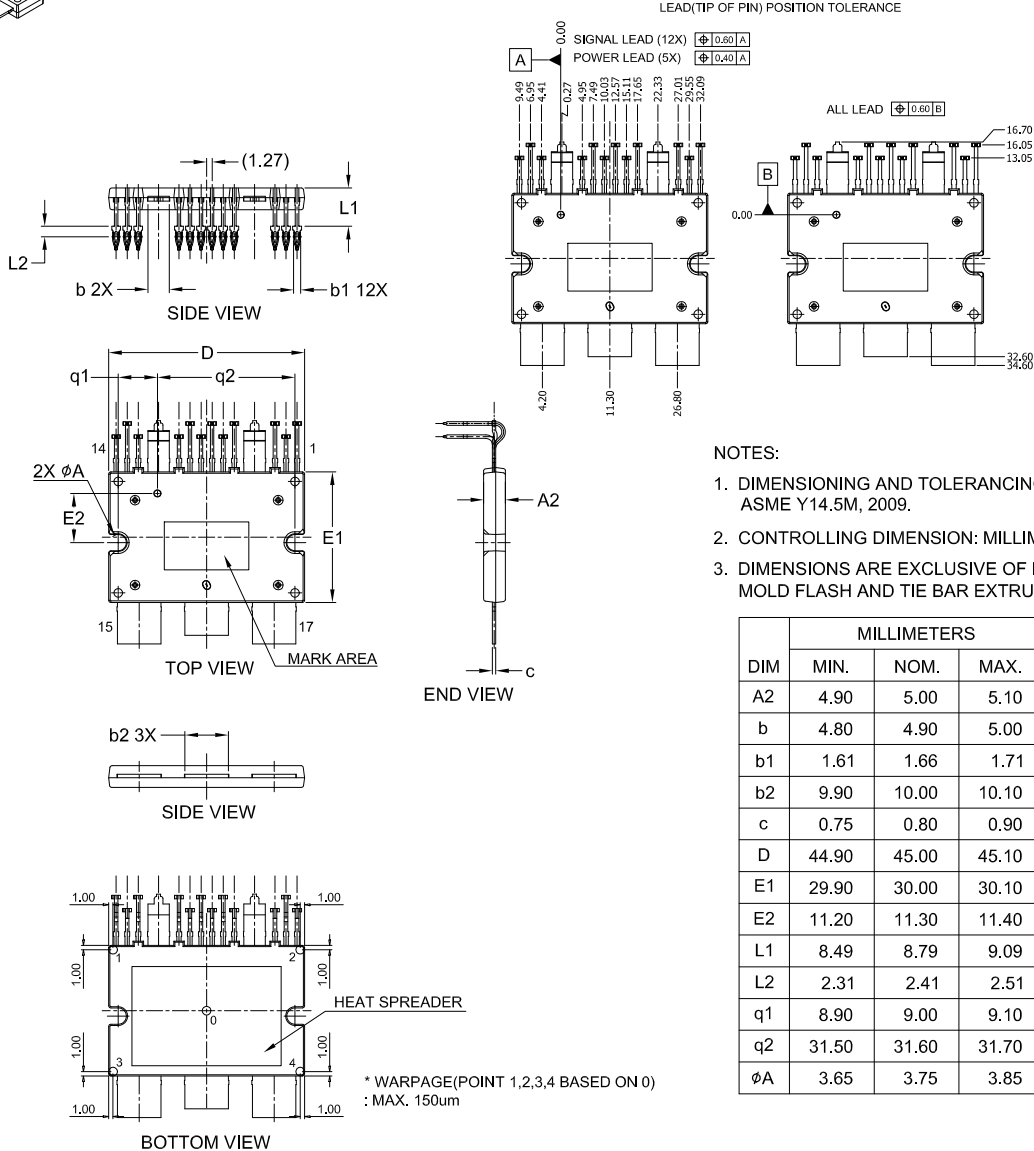

GENERIC MARKING DIAGRAM*

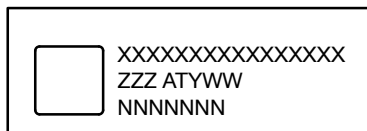

XXX = Specific Device Code
ZZZ = Assembly Lot Code
A = Assembly Site
T = Test Site
Y = Year
WW = Work Week
NN = Serial Number

*This information is generic. Please refer to device data sheet for actual part marking. Pb-Free indicator, "G" or microdot "μ", may or may not be present. Some products may not follow the Generic Marking.

DOCUMENT NUMBER:	98AON29464H	Electronic versions are uncontrolled except when accessed directly from the Document Repository. Printed versions are uncontrolled except when stamped "CONTROLLED COPY" in red.
DESCRIPTION:	APM17-MFA, AUTOMOTIVE MODULE	PAGE 1 OF 1

onsemi and ONSEMI are trademarks of Semiconductor Components Industries, LLC dba onsemi or its subsidiaries in the United States and/or other countries. onsemi reserves the right to make changes without further notice to any products herein. onsemi makes no warranty, representation or guarantee regarding the suitability of its products for any particular purpose, nor does onsemi assume any liability arising out of the application or use of any product or circuit, and specifically disclaims any and all liability, including without limitation special, consequential or incidental damages. onsemi does not convey any license under its patent rights nor the rights of others.

onsemi, **Onsemi**, and other names, marks, and brands are registered and/or common law trademarks of Semiconductor Components Industries, LLC dba "**onsemi**" or its affiliates and/or subsidiaries in the United States and/or other countries. **onsemi** owns the rights to a number of patents, trademarks, copyrights, trade secrets, and other intellectual property. A listing of **onsemi**'s product/patent coverage may be accessed at www.onsemi.com/site/pdf/Patent-Marking.pdf. **onsemi** reserves the right to make changes at any time to any products or information herein, without notice. The information herein is provided "as-is" and **onsemi** makes no warranty, representation or guarantee regarding the accuracy of the information, product features, availability, functionality, or suitability of its products for any particular purpose, nor does **onsemi** assume any liability arising out of the application or use of any product or circuit, and specifically disclaims any and all liability, including without limitation special, consequential or incidental damages. Buyer is responsible for its products and applications using **onsemi** products, including compliance with all laws, regulations and safety requirements or standards, regardless of any support or applications information provided by **onsemi**. "Typical" parameters which may be provided in **onsemi** data sheets and/or specifications can and do vary in different applications and actual performance may vary over time. All operating parameters, including "Typicals" must be validated for each customer application by customer's technical experts. **onsemi** does not convey any license under any of its intellectual property rights nor the rights of others. **onsemi** products are not designed, intended, or authorized for use as a critical component in life support systems or any FDA Class 3 medical devices or medical devices with a same or similar classification in a foreign jurisdiction or any devices intended for implantation in the human body. Should Buyer purchase or use **onsemi** products for any such unintended or unauthorized application, Buyer shall indemnify and hold **onsemi** and its officers, employees, subsidiaries, affiliates, and distributors harmless against all claims, costs, damages, and expenses, and reasonable attorney fees arising out of, directly or indirectly, any claim of personal injury or death associated with such unintended or unauthorized use, even if such claim alleges that **onsemi** was negligent regarding the design or manufacture of the part. **onsemi** is an Equal Opportunity/Affirmative Action Employer. This literature is subject to all applicable copyright laws and is not for resale in any manner.

ADDITIONAL INFORMATION

TECHNICAL PUBLICATIONS:

Technical Library: www.onsemi.com/design/resources/technical-documentation
onsemi Website: www.onsemi.com

ONLINE SUPPORT: www.onsemi.com/support

For additional information, please contact your local Sales Representative at www.onsemi.com/support/sales