

# PZT2907A

## PNP Silicon Epitaxial Transistor

This PNP Silicon Epitaxial transistor is designed for use in linear and switching applications. The device is housed in the SOT-223 package which is designed for medium power surface mount applications.

### Features

- NPN Complement is PZT2222AT1
- The SOT-223 Package can be Soldered Using Wave or Reflow
- SOT-223 Package Ensures Level Mounting, Resulting in Improved Thermal Conduction, and Allows Visual Inspection of Soldered Joints. The Formed Leads Absorb Thermal Stress during Soldering Eliminating the Possibility of Damage to the Die
- S Prefix for Automotive and Other Applications Requiring Unique Site and Control Change Requirements; AEC-Q101 Qualified and PPAP Capable
- These Devices are Pb-Free, Halogen Free/BFR Free and are RoHS Compliant\*

### MAXIMUM RATINGS

Rating	Symbol	Value	Unit
Collector - Emitter Voltage	$V_{CEO}$	-60	Vdc
Collector - Base Voltage	$V_{CBO}$	-60	Vdc
Emitter - Base Voltage	$V_{EBO}$	-5.0	Vdc
Collector Current - Continuous	$I_C$	-600	mAdc

Stresses exceeding Maximum Ratings may damage the device. Maximum Ratings are stress ratings only. Functional operation above the Recommended Operating Conditions is not implied. Extended exposure to stresses above the Recommended Operating Conditions may affect device reliability.

### THERMAL CHARACTERISTICS

Characteristic	Symbol	Max	Unit
Total Device Dissipation (Note 1) $T_A = 25^\circ\text{C}$	$P_D$	1.5 12	W mW/°C
Thermal Resistance Junction-to-Ambient (Note 1)	$R_{\theta JA}$	83.3	°C/W
Lead Temperature for Soldering, 0.0625" from case Time in Solder Bath	$T_L$	260 10	°C Sec
Operating and Storage Temperature Range	$T_J, T_{stg}$	-65 to +150	°C

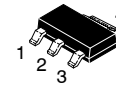
1. FR-4 with 1 oz and 713 mm<sup>2</sup> of copper area.

\*For additional information on our Pb-Free strategy and soldering details, please download the ON Semiconductor Soldering and Mounting Techniques Reference Manual, SOLDERRM/D.

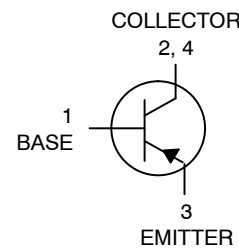


ON Semiconductor®

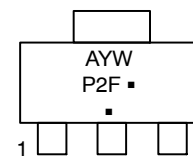
<http://onsemi.com>



SOT-223  
CASE 318E  
STYLE 1



### MARKING DIAGRAM



- P2F = Specific Device Code
- A = Assembly Location
- Y = Year
- W = Work Week
- = Pb-Free Package

(Note: Microdot may be in either location)

### ORDERING INFORMATION

Device	Package	Shipping†
PZT2907AT1G	SOT-223 (Pb-Free)	1,000 / Tape & Reel
SPZT2907AT1G	SOT-223 (Pb-Free)	1,000 / Tape & Reel
PZT2907AT3G	SOT-223 (Pb-Free)	4,000 / Tape & Reel

†For information on tape and reel specifications, including part orientation and tape sizes, please refer to our Tape and Reel Packaging Specifications Brochure, BRD8011/D.

# PZT2907A

## ELECTRICAL CHARACTERISTICS ( $T_A = 25^\circ\text{C}$ unless otherwise noted)

Characteristic	Symbol	Min	Typ	Max	Unit
----------------	--------	-----	-----	-----	------

### OFF CHARACTERISTICS

Collector-Base Breakdown Voltage ( $I_C = -10 \mu\text{Adc}$ , $I_E = 0$ )	$V_{(BR)CBO}$	-60	-	-	Vdc
Collector-Emitter Breakdown Voltage ( $I_C = 10 \text{ mAdc}$ , $I_B = 0$ )	$V_{(BR)CEO}$	-60	-	-	Vdc
Emitter-Base Breakdown Voltage ( $I_E = -10 \mu\text{Adc}$ , $I_C = 0$ )	$V_{(BR)EBO}$	-5.0	-	-	Vdc
Collector-Base Cutoff Current ( $V_{CB} = -50 \text{ Vdc}$ , $I_E = 0$ )	$I_{CBO}$	-	-	-10	nAdc
Collector-Emitter Cutoff Current ( $V_{CE} = -30 \text{ Vdc}$ , $V_{BE} = 0.5 \text{ Vdc}$ )	$I_{CEX}$	-	-	-50	nAdc
Base-Emitter Cutoff Current ( $V_{CE} = -30 \text{ Vdc}$ , $V_{BE} = -0.5 \text{ Vdc}$ )	$I_{BEX}$	-	-	-50	nAdc

### ON CHARACTERISTICS (Note 2)

DC Current Gain ( $I_C = -0.1 \text{ mAdc}$ , $V_{CE} = -10 \text{ Vdc}$ ) ( $I_C = -1.0 \text{ mAdc}$ , $V_{CE} = -10 \text{ Vdc}$ ) ( $I_C = -10 \text{ mAdc}$ , $V_{CE} = -10 \text{ Vdc}$ ) ( $I_C = -150 \text{ mAdc}$ , $V_{CE} = -10 \text{ Vdc}$ ) ( $I_C = -500 \text{ mAdc}$ , $V_{CE} = -10 \text{ Vdc}$ )	$h_{FE}$	75 100 100 100 50	- - - - -	- - - 300 -	-
Collector-Emitter Saturation Voltages ( $I_C = -150 \text{ mAdc}$ , $I_B = -15 \text{ mAdc}$ ) ( $I_C = -500 \text{ mAdc}$ , $I_B = -50 \text{ mAdc}$ )	$V_{CE(sat)}$	- -	- -	-0.4 -1.6	Vdc
Base-Emitter Saturation Voltages ( $I_C = -150 \text{ mAdc}$ , $I_B = -15 \text{ mAdc}$ ) ( $I_C = -500 \text{ mAdc}$ , $I_B = -50 \text{ mAdc}$ )	$V_{BE(sat)}$	- -	- -	-1.3 -2.6	Vdc

### DYNAMIC CHARACTERISTICS

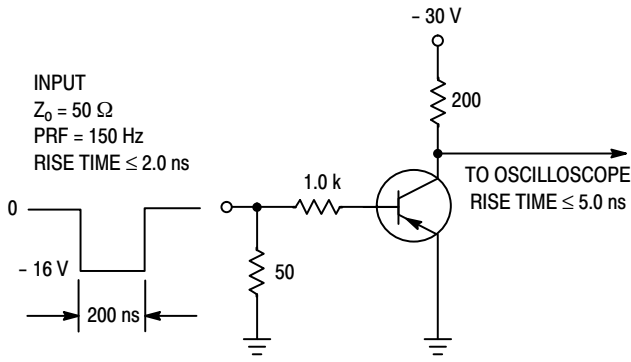
Current-Gain - Bandwidth Product ( $I_C = -50 \text{ mAdc}$ , $V_{CE} = -20 \text{ Vdc}$ , $f = 100 \text{ MHz}$ )	$f_T$	200	-	-	MHz
Output Capacitance ( $V_{CB} = -10 \text{ Vdc}$ , $I_E = 0$ , $f = 1.0 \text{ MHz}$ )	$C_C$	-	-	8.0	pF
Input Capacitance ( $V_{EB} = -2.0 \text{ Vdc}$ , $I_C = 0$ , $f = 1.0 \text{ MHz}$ )	$C_e$	-	-	30	pF

### SWITCHING TIMES

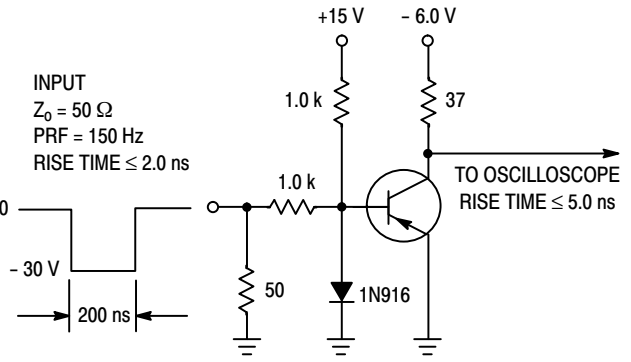
Turn-On Time	$(V_{CC} = -30 \text{ Vdc}$ , $I_C = -150 \text{ mAdc}$ , $I_{B1} = -15 \text{ mAdc}$ )	$t_{on}$	-	-	45	ns
Delay Time		$t_d$	-	-	10	
Rise Time		$t_r$	-	-	40	
Turn-Off Time	$(V_{CC} = -6.0 \text{ Vdc}$ , $I_C = -150 \text{ mAdc}$ , $I_{B1} = I_{B2} = -15 \text{ mAdc}$ )	$t_{off}$	-	-	100	ns
Storage Time		$t_s$	-	-	80	
Fall Time		$t_f$	-	-	30	

2. Pulse Test: Pulse Width  $\leq 300 \mu\text{s}$ , Duty Cycle  $\leq 2.0\%$ .

# PZT2907A

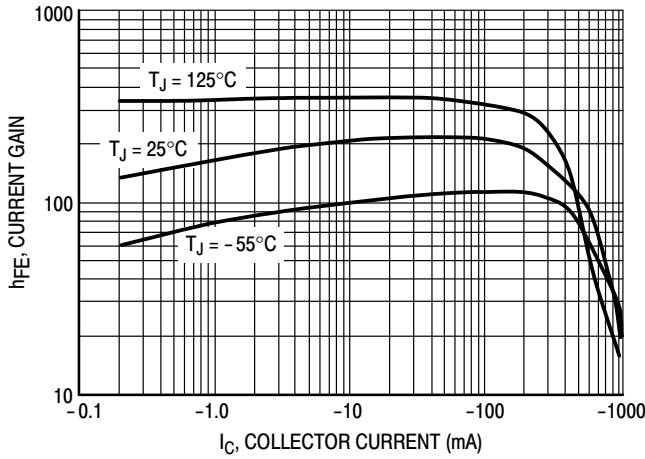


**Figure 1. Delay and Rise Time Test Circuit**

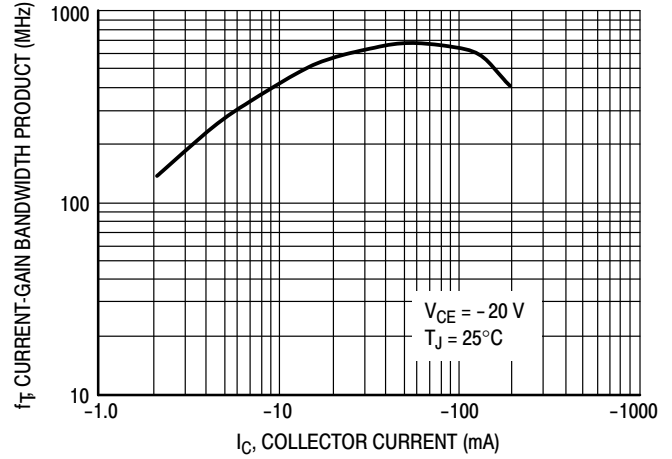


**Figure 2. Storage and Fall Time Test Circuit**

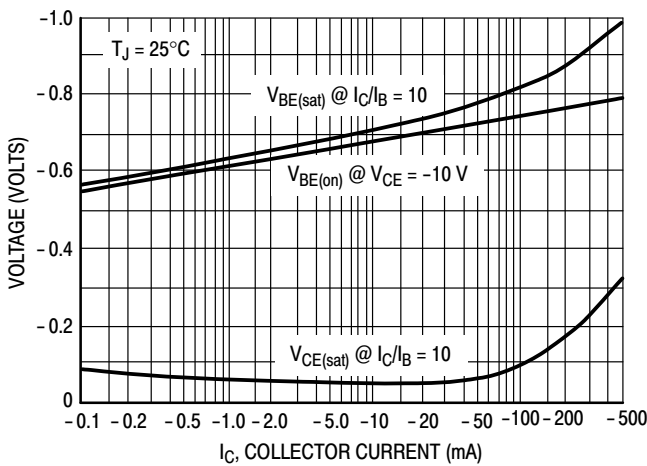
## TYPICAL ELECTRICAL CHARACTERISTICS



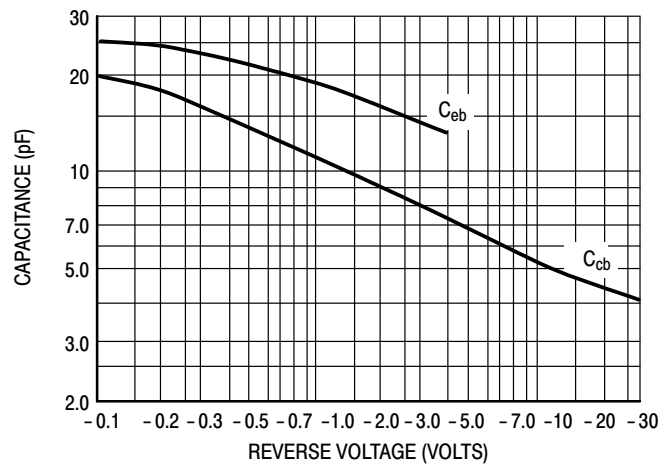
**Figure 3. DC Current Gain**



**Figure 4. Current Gain Bandwidth Product**



**Figure 5. "ON" Voltage**



**Figure 6. Capacitances**

# MECHANICAL CASE OUTLINE

## PACKAGE DIMENSIONS

ON Semiconductor®



SCALE 1:1

SOT-223 (TO-261)  
CASE 318E-04  
ISSUE R

DATE 02 OCT 2018



NOTES:

1. DIMENSIONING AND TOLERANCING PER ASME Y14.5M, 1994.
2. CONTROLLING DIMENSION: MILLIMETERS
3. DIMENSIONS D & E DO NOT INCLUDE MOLD FLASH, PROTRUSIONS OR GATE BURRS. MOLD FLASH, PROTRUSIONS OR GATE BURRS SHALL NOT EXCEED 0.200MM PER SIDE.
4. DATUMS A AND B ARE DETERMINED AT DATUM H.
5. A1 IS DEFINED AS THE VERTICAL DISTANCE FROM THE SEATING PLANE TO THE LOWEST POINT OF THE PACKAGE BODY.
6. POSITIONAL TOLERANCE APPLIES TO DIMENSIONS b AND b1.

MILLIMETERS			
DIM	MIN.	NOM.	MAX.
A	1.50	1.63	1.75
A1	0.02	0.06	0.10
b	0.60	0.75	0.89
b1	2.90	3.06	3.20
c	0.24	0.29	0.35
D	6.30	6.50	6.70
E	3.30	3.50	3.70
e	2.30 BSC		
L	0.20	---	---
L1	1.50	1.75	2.00
He	6.70	7.00	7.30
θ	0°	---	10°



DOCUMENT NUMBER:	98ASB42680B	Electronic versions are uncontrolled except when accessed directly from the Document Repository. Printed versions are uncontrolled except when stamped "CONTROLLED COPY" in red.
DESCRIPTION:	SOT-223 (TO-261)	PAGE 1 OF 2

ON Semiconductor and are trademarks of Semiconductor Components Industries, LLC dba ON Semiconductor or its subsidiaries in the United States and/or other countries. ON Semiconductor reserves the right to make changes without further notice to any products herein. ON Semiconductor makes no warranty, representation or guarantee regarding the suitability of its products for any particular purpose, nor does ON Semiconductor assume any liability arising out of the application or use of any product or circuit, and specifically disclaims any and all liability, including without limitation special, consequential or incidental damages. ON Semiconductor does not convey any license under its patent rights nor the rights of others.

**SOT-223 (TO-261)**  
**CASE 318E-04**  
**ISSUE R**

DATE 02 OCT 2018

- |  |   |   |   |   |
|--|---|---|---|---|
| <b>STYLE 1:</b><br>PIN 1. BASE<br>2. COLLECTOR<br>3. EMITTER<br>4. COLLECTOR | <b>STYLE 2:</b><br>PIN 1. ANODE<br>2. CATHODE<br>3. NC<br>4. CATHODE        | <b>STYLE 3:</b><br>PIN 1. GATE<br>2. DRAIN<br>3. SOURCE<br>4. DRAIN           | <b>STYLE 4:</b><br>PIN 1. SOURCE<br>2. DRAIN<br>3. GATE<br>4. DRAIN   | <b>STYLE 5:</b><br>PIN 1. DRAIN<br>2. GATE<br>3. SOURCE<br>4. GATE    |
| <b>STYLE 6:</b><br>PIN 1. RETURN<br>2. INPUT<br>3. OUTPUT<br>4. INPUT        | <b>STYLE 7:</b><br>PIN 1. ANODE 1<br>2. CATHODE<br>3. ANODE 2<br>4. CATHODE | <b>STYLE 8:</b><br>CANCELLED  | <b>STYLE 9:</b><br>PIN 1. INPUT<br>2. GROUND<br>3. LOGIC<br>4. GROUND | <b>STYLE 10:</b><br>PIN 1. CATHODE<br>2. ANODE<br>3. GATE<br>4. ANODE |
| <b>STYLE 11:</b><br>PIN 1. MT 1<br>2. MT 2<br>3. GATE<br>4. MT 2             | <b>STYLE 12:</b><br>PIN 1. INPUT<br>2. OUTPUT<br>3. NC<br>4. OUTPUT         | <b>STYLE 13:</b><br>PIN 1. GATE<br>2. COLLECTOR<br>3. EMITTER<br>4. COLLECTOR |   |   |

**GENERIC  
 MARKING DIAGRAM\***



- A = Assembly Location
- Y = Year
- W = Work Week
- XXXXX = Specific Device Code
- = Pb-Free Package

(Note: Microdot may be in either location)

\*This information is generic. Please refer to device data sheet for actual part marking. Pb-Free indicator, "G" or microdot "▪", may or may not be present. Some products may not follow the Generic Marking.

<b>DOCUMENT NUMBER:</b>	<b>98ASB42680B</b>	Electronic versions are uncontrolled except when accessed directly from the Document Repository. Printed versions are uncontrolled except when stamped "CONTROLLED COPY" in red.
<b>DESCRIPTION:</b>	<b>SOT-223 (TO-261)</b>	<b>PAGE 2 OF 2</b>

ON Semiconductor and  are trademarks of Semiconductor Components Industries, LLC dba ON Semiconductor or its subsidiaries in the United States and/or other countries. ON Semiconductor reserves the right to make changes without further notice to any products herein. ON Semiconductor makes no warranty, representation or guarantee regarding the suitability of its products for any particular purpose, nor does ON Semiconductor assume any liability arising out of the application or use of any product or circuit, and specifically disclaims any and all liability, including without limitation special, consequential or incidental damages. ON Semiconductor does not convey any license under its patent rights nor the rights of others.

**onsemi**, **Onsemi**, and other names, marks, and brands are registered and/or common law trademarks of Semiconductor Components Industries, LLC dba "**onsemi**" or its affiliates and/or subsidiaries in the United States and/or other countries. **onsemi** owns the rights to a number of patents, trademarks, copyrights, trade secrets, and other intellectual property. A listing of **onsemi**'s product/patent coverage may be accessed at [www.onsemi.com/site/pdf/Patent-Marking.pdf](http://www.onsemi.com/site/pdf/Patent-Marking.pdf). **onsemi** reserves the right to make changes at any time to any products or information herein, without notice. The information herein is provided "as-is" and **onsemi** makes no warranty, representation or guarantee regarding the accuracy of the information, product features, availability, functionality, or suitability of its products for any particular purpose, nor does **onsemi** assume any liability arising out of the application or use of any product or circuit, and specifically disclaims any and all liability, including without limitation special, consequential or incidental damages. Buyer is responsible for its products and applications using **onsemi** products, including compliance with all laws, regulations and safety requirements or standards, regardless of any support or applications information provided by **onsemi**. "Typical" parameters which may be provided in **onsemi** data sheets and/or specifications can and do vary in different applications and actual performance may vary over time. All operating parameters, including "Typicals" must be validated for each customer application by customer's technical experts. **onsemi** does not convey any license under any of its intellectual property rights nor the rights of others. **onsemi** products are not designed, intended, or authorized for use as a critical component in life support systems or any FDA Class 3 medical devices or medical devices with a same or similar classification in a foreign jurisdiction or any devices intended for implantation in the human body. Should Buyer purchase or use **onsemi** products for any such unintended or unauthorized application, Buyer shall indemnify and hold **onsemi** and its officers, employees, subsidiaries, affiliates, and distributors harmless against all claims, costs, damages, and expenses, and reasonable attorney fees arising out of, directly or indirectly, any claim of personal injury or death associated with such unintended or unauthorized use, even if such claim alleges that **onsemi** was negligent regarding the design or manufacture of the part. **onsemi** is an Equal Opportunity/Affirmative Action Employer. This literature is subject to all applicable copyright laws and is not for resale in any manner.

---

## ADDITIONAL INFORMATION

### TECHNICAL PUBLICATIONS:

Technical Library: [www.onsemi.com/design/resources/technical-documentation](http://www.onsemi.com/design/resources/technical-documentation)  
onsemi Website: [www.onsemi.com](http://www.onsemi.com)

### ONLINE SUPPORT: [www.onsemi.com/support](http://www.onsemi.com/support)

For additional information, please contact your local Sales Representative at [www.onsemi.com/support/sales](http://www.onsemi.com/support/sales)