

# Schottky Rectifier

## SS23, SS24, SS25, SS26, SS28, SS29, S210

The SS23–S210 series includes high–efficiency, low power loss, general–purpose Schottky rectifiers. The clip–bonded leg structure provides high thermal performance and low electrical resistance. These rectifier are suited for free wheeling, secondary rectification, and reverse polarity protection applications.

### Features

- Glass–Passivated Junctions
- High–Current Capability, Low  $V_F$
- This is a Pb–Free and Halid Free Device

### Applications:

- Low Voltage
- High–Frequency Inverters
- Free Wheeling
- Polarity Protection

## SCHOTTKY BARRIER RECTIFIER 2.0 AMPERES



SMB  
CASE 403AF

### MARKING DIAGRAM

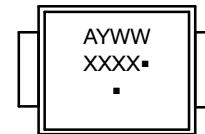

XXXX = Specific Device Code  
 A = Assembly Location  
 Y = Year  
 WW = Work Week  
 ▪ = Pb–Free Package

(Note: Microdot may be in either location)

### ORDERING INFORMATION

Part Number	Device Code Marking	Package	Shipping <sup>†</sup>
SS23	SS23	SMB (Pb–Free)	3000 / Tape & Reel
SS24	SS24		
SS25	SS25		
SS26	SS26		
SS28	SS28		
SS29	SS29		
S210	S210		

<sup>†</sup>For information on tape and reel specifications, including part orientation and tape sizes, please refer to our Tape and Reel Packaging Specification Brochure, [BRD8011/D](#).

## SS23, SS24, SS25, SS26, SS28, SS29, S210

### MAXIMUM RATINGS ( $T_A = 25^\circ\text{C}$ unless otherwise noted)

Rating	Symbol	Value							Unit
		SS23	SS24	SS25	SS26	SS28	SS29	S210	
Maximum Repetitive Reverse Voltage	$V_{RRM}$	30	40	50	60	80	90	100	V
Maximum Average Forward Current: 0.375-inch Lead Length at $T_A = 75^\circ\text{C}$	$I_{F(AV)}$	2.0							A
Non-Repetitive Peak Forward Surge Current: 8.3 ms Single Half-Sine Wave	$I_{FSM}$	50							A
Storage Temperature Range	$T_{STG}$	-65 to +150							$^\circ\text{C}$
Operating Junction Temperature	$T_J$	-65 to +125							$^\circ\text{C}$

Stresses exceeding those listed in the Maximum Ratings table may damage the device. If any of these limits are exceeded, device functionality should not be assumed, damage may occur and reliability may be affected.

### THERMAL CHARACTERISTICS

Characteristic	Symbol	Value	Unit
Power Dissipation	$P_D$	1.3	W
Thermal Resistance, Junction to Ambient (Note 1)	$R_{\theta JA}$	75	$^\circ\text{C}/\text{W}$

1. Device mounted on FE-4 PCB 0.013 mm.

### ELECTRICAL CHARACTERISTICS ( $T_A = 25^\circ\text{C}$ unless otherwise noted)

Symbol	Rating	Test Conditions	Value							Unit
			SS23	SS24	SS25	SS26	SS28	SS29	S210	
$V_F$	Forward Voltage	$I_F = 2.0\text{ A}$	500		700		850			mV
$I_R$	Reverse Current at Rated $V_R$	$T_A = 25^\circ\text{C}$	0.4							mA
		$T_A = 100^\circ\text{C}$	10							

Product parametric performance is indicated in the Electrical Characteristics for the listed test conditions, unless otherwise noted. Product performance may not be indicated by the Electrical Characteristics if operated under different conditions.

TYPICAL CHARACTERISTICS

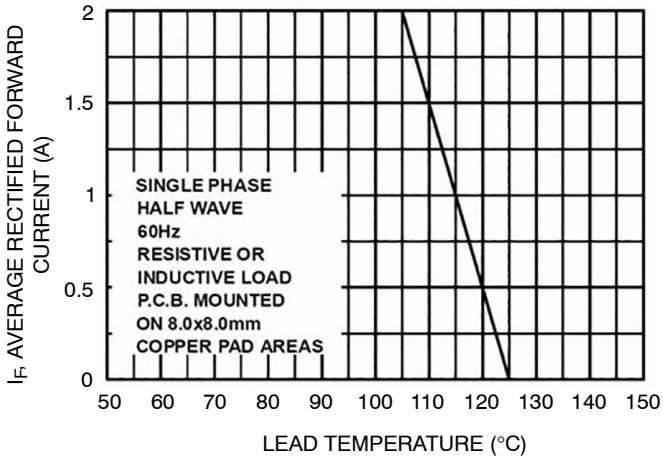

Figure 1. Forward Current Derating Curve

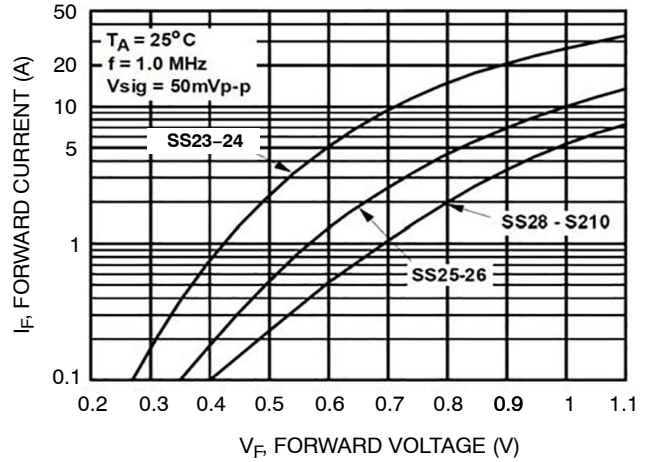

Figure 2. Forward Current Characteristics

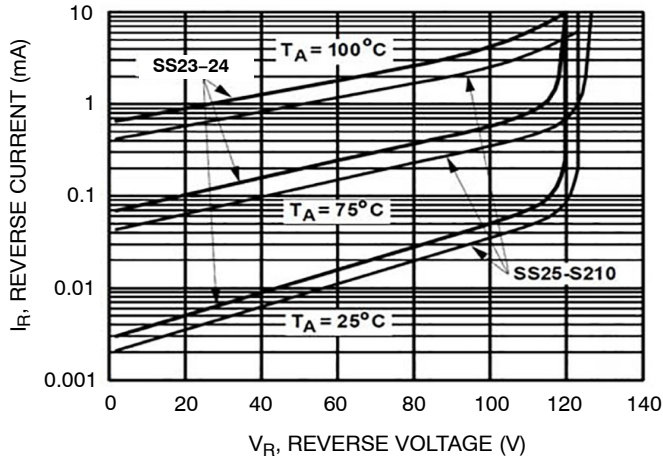

Figure 3. Reverse Current vs. Reverse Voltage

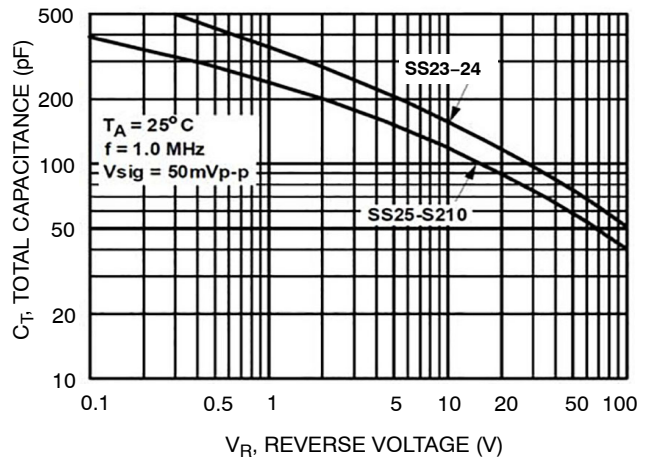

Figure 4. Total Capacitance

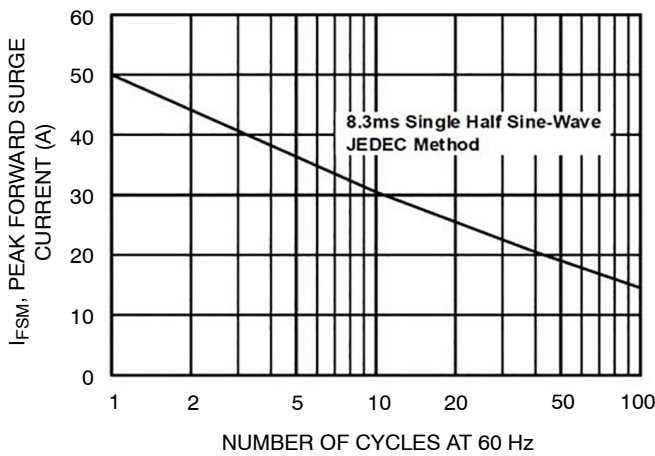

Figure 5. Non-Repetitive Surge Current

# MECHANICAL CASE OUTLINE

## PACKAGE DIMENSIONS

ON Semiconductor®



### SMB CASE 403AF ISSUE O

DATE 31 AUG 2016

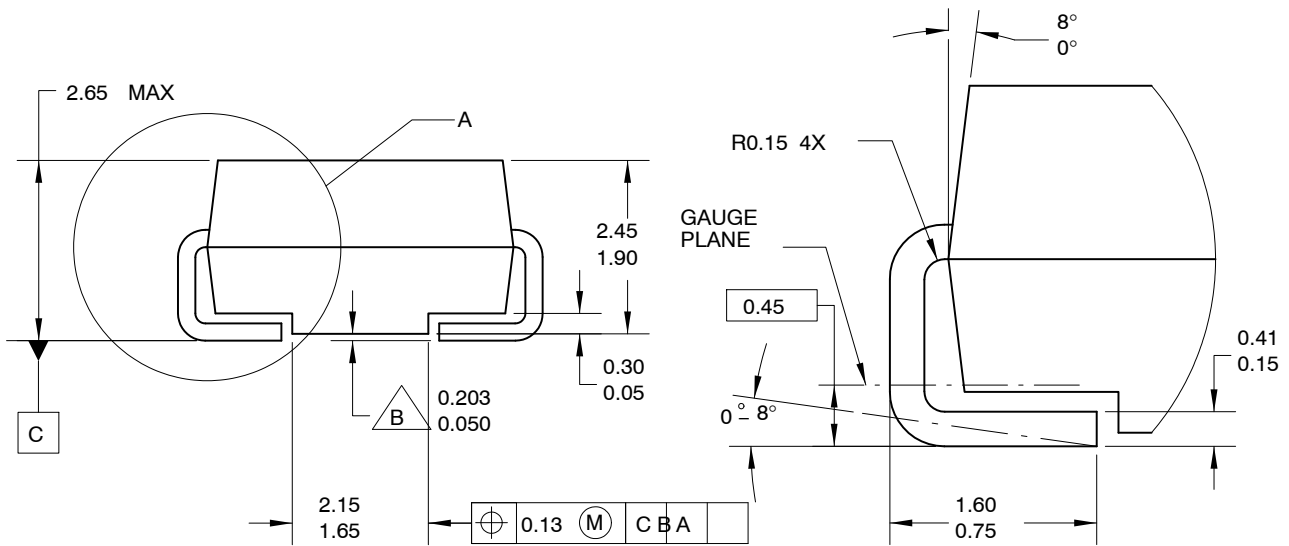
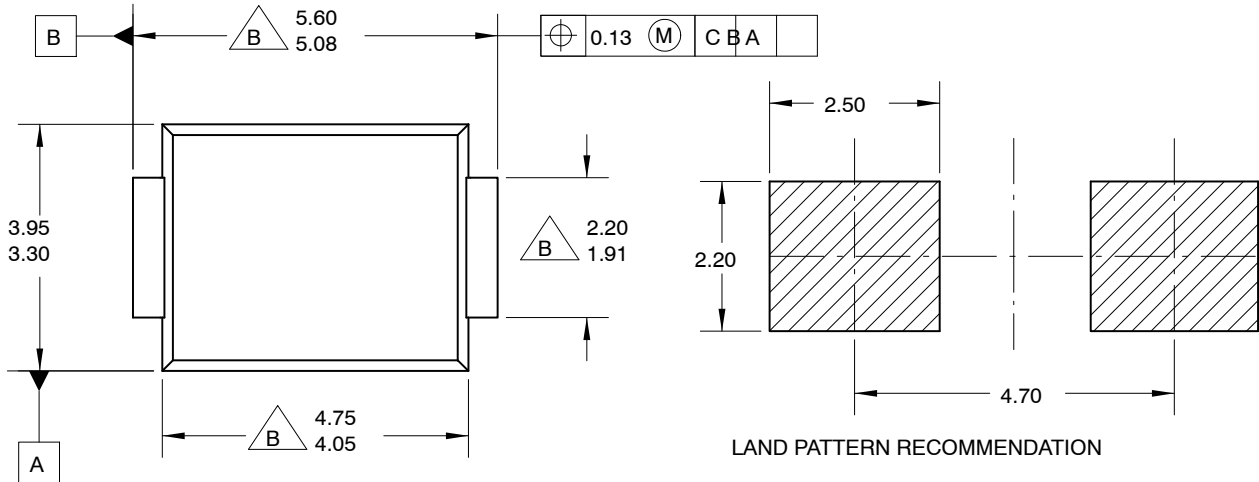

DETAIL A  
SCALE 20 : 1

**NOTES:**

- A. EXCEPT WHERE NOTED CONFORMS TO JEDEC DO214 VARIATION AA.
- B. DOES NOT COMPLY JEDEC STD. VALUE.
- C. ALL DIMENSIONS ARE IN MILLIMETERS.
- D. DIMENSIONS ARE EXCLUSIVE OF BURRS, MOLD FLASH AND TIE BAR PROTRUSIONS.
- E. DIMENSION AND TOLERANCE AS PER ASME Y14.5-1994.
- F. LAND PATTERN STD. DIOM5336X240M.

<b>DOCUMENT NUMBER:</b>	<b>98AON13441G</b>	Electronic versions are uncontrolled except when accessed directly from the Document Repository. Printed versions are uncontrolled except when stamped "CONTROLLED COPY" in red.
<b>DESCRIPTION:</b>	<b>SMB</b>	<b>PAGE 1 OF 1</b>

ON Semiconductor and are trademarks of Semiconductor Components Industries, LLC dba ON Semiconductor or its subsidiaries in the United States and/or other countries. ON Semiconductor reserves the right to make changes without further notice to any products herein. ON Semiconductor makes no warranty, representation or guarantee regarding the suitability of its products for any particular purpose, nor does ON Semiconductor assume any liability arising out of the application or use of any product or circuit, and specifically disclaims any and all liability, including without limitation special, consequential or incidental damages. ON Semiconductor does not convey any license under its patent rights nor the rights of others.

**onsemi**, **Onsemi**, and other names, marks, and brands are registered and/or common law trademarks of Semiconductor Components Industries, LLC dba "**onsemi**" or its affiliates and/or subsidiaries in the United States and/or other countries. **onsemi** owns the rights to a number of patents, trademarks, copyrights, trade secrets, and other intellectual property. A listing of **onsemi**'s product/patent coverage may be accessed at [www.onsemi.com/site/pdf/Patent-Marking.pdf](http://www.onsemi.com/site/pdf/Patent-Marking.pdf). **onsemi** reserves the right to make changes at any time to any products or information herein, without notice. The information herein is provided "as-is" and **onsemi** makes no warranty, representation or guarantee regarding the accuracy of the information, product features, availability, functionality, or suitability of its products for any particular purpose, nor does **onsemi** assume any liability arising out of the application or use of any product or circuit, and specifically disclaims any and all liability, including without limitation special, consequential or incidental damages. Buyer is responsible for its products and applications using **onsemi** products, including compliance with all laws, regulations and safety requirements or standards, regardless of any support or applications information provided by **onsemi**. "Typical" parameters which may be provided in **onsemi** data sheets and/or specifications can and do vary in different applications and actual performance may vary over time. All operating parameters, including "Typicals" must be validated for each customer application by customer's technical experts. **onsemi** does not convey any license under any of its intellectual property rights nor the rights of others. **onsemi** products are not designed, intended, or authorized for use as a critical component in life support systems or any FDA Class 3 medical devices or medical devices with a same or similar classification in a foreign jurisdiction or any devices intended for implantation in the human body. Should Buyer purchase or use **onsemi** products for any such unintended or unauthorized application, Buyer shall indemnify and hold **onsemi** and its officers, employees, subsidiaries, affiliates, and distributors harmless against all claims, costs, damages, and expenses, and reasonable attorney fees arising out of, directly or indirectly, any claim of personal injury or death associated with such unintended or unauthorized use, even if such claim alleges that **onsemi** was negligent regarding the design or manufacture of the part. **onsemi** is an Equal Opportunity/Affirmative Action Employer. This literature is subject to all applicable copyright laws and is not for resale in any manner.

## ADDITIONAL INFORMATION

### TECHNICAL PUBLICATIONS:

Technical Library: [www.onsemi.com/design/resources/technical-documentation](http://www.onsemi.com/design/resources/technical-documentation)  
onsemi Website: [www.onsemi.com](http://www.onsemi.com)

### ONLINE SUPPORT: [www.onsemi.com/support](http://www.onsemi.com/support)

For additional information, please contact your local Sales Representative at [www.onsemi.com/support/sales](http://www.onsemi.com/support/sales)