

NCV705XXGEVK

NCV705XX Micro-stepping Motor Driver Evaluation Board User's Manual



ON Semiconductor®

www.onsemi.com

Introduction

The evaluation board allows in an easy way to demonstrate features of NCV705xx device family – a micro-stepping stepper motor drivers for bipolar stepper motors. With supporting GUI SW it is possible to create and apply different speed profiles and characterize the Bemf (Back electromotive force) performance of specific setup. GUI SW allows to access and control any register or external I/O pin of the devices.

The provided motherboard gives a lot of flexibility during your development process. Easy access to several signals makes debugging very easy and gives you the possibility to connect the evaluation kit with your own application which reduces the development time.

Evaluation of the complete NCV705xx family is made very easy by means of the separate daughter boards.

NCV705xx family contains a current-translation table and takes the next micro-step depending on provided clock signal. Error message is provided if an electrical error, an under-voltage or an elevated junction temperature is detected. Proprietary PWM algorithm for reliable current control is used.

NCV705xx family is fully compatible with the automotive voltage requirements and is ideally suited for general-purpose stepper motor applications in the automotive, industrial, medical, and marine environment. Due to the technology, devices are especially suited for use in applications with fluctuating battery supplies.

EVAL BOARD USER'S MANUAL

Evaluation Board Features

- Wide Range of Supply Voltage: 6 to 29 V
- Connection of Bipolar Stepper Motor
- Test Points for Every Signal
- Preparation for Daisy-chain Connection of more Devices
- Single Side PCB Assembly
- User Friendly GUI SW

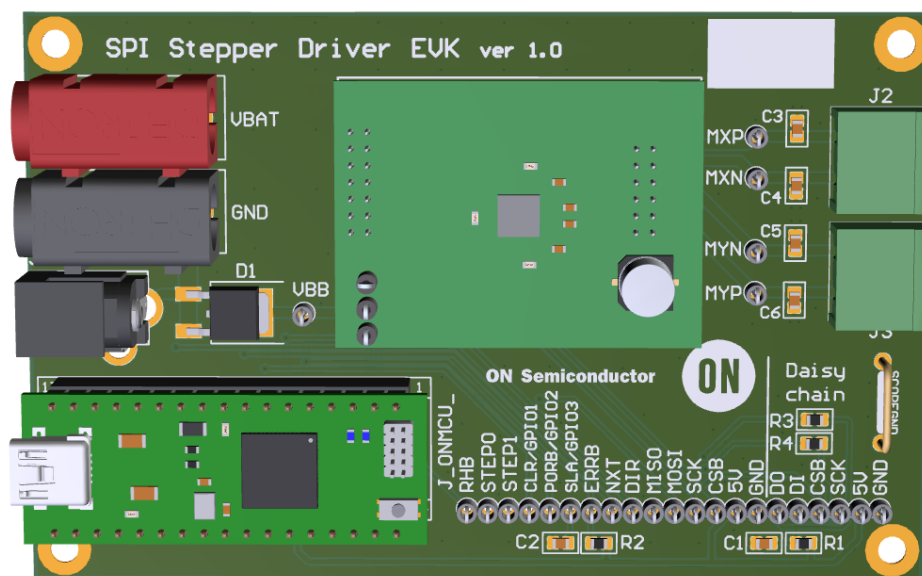

Figure 1. Evaluation Board (Top View)

NCV705XXGEVK

Table 1. ABSOLUTE MAXIMUM RATINGS

Rating	Value	Unit
Supply Voltage (V_{BAT})	-0.3 to 40	V
Stepper Motor Current	2	A
Junction Temperature (NCV70517, NCV70514, NCV70516)	-40 to 175	°C
Ambient Temperature	-40 to 105	°C

Stresses exceeding those listed in the Maximum Ratings table may damage the device. If any of these limits are exceeded, device functionality should not be assumed, damage may occur and reliability may be affected.

Table 2. RECOMMENDED BOARD OPERATING CONDITIONS

Rating	Value	Unit
Supply Voltage (V_{BAT})	6 to 29	V
Stepper Motor Current	1.1	A
Ambient Temperature	-40 to 105	°C

Functional operation above the stresses listed in the Recommended Operating Ranges is not implied. Extended exposure to stresses beyond the Recommended Operating Ranges limits may affect device reliability.

Table 3. INTERFACE FUNCTION DESCRIPTION

Connector Name	Connector Type	Description / Function
J1	DC POWER JACK 2.5MM	Input supply connector, DC 6 – 29 V
VBAT	BANANA RED 4MM	Input supply connector, positive, 6 – 29 V
GND	BANANA BLACK 4MM	Input supply connector, GND
J_ONMCU_	2 pcs 1x17 pins / 2.54 mm / Socket Header	Connector for ONMCU_DIL microcontroller board
CON1	HARWIN_M80-8501445 14WAY/2x7/Socket 2MM	Connector for NCV705XX Daughterboard
CON2	HARWIN_M80-8501245 16WAY/2x8/Socket 2MM	Connector for NCV705XX Daughterboard
J2, J3	2 pins / 5.08 mm / Header Terminal Block	Connection of Stepper Motor
SCOPEGND	Wire Bridge	Ground wire, global ground
Test points	TEST POINT TH 1MM	Easy access to all signals

NCV705XXGEVK

Getting Started

The evaluation board can be supplied through a standard 5.5 x 2.5 mm power jack DC connector, but preferred way is to connect current limited laboratory power supply through standard 4 mm bananas. Supply voltage is then provided to battery voltage input VBB of NCV705xx Stepper Driver through reverse polarity protection diode.

Battery voltage should be connected first, followed by connection of USB mini cable.

J2 and J3 connectors are intended for connection of bipolar stepper motor, each winding going to separate connector. Swapping of positive and negative terminals will just cause opposite direction of motor rotation.

CON1 and CON2 serve to plug any compatible daughter board with stepper driver IC.

Microcontroller board ONMCU_DIL creates communication bridge and translates dedicated text protocol commands going over USB into SPI commands for stepper driver IC or control of external I/O pins.

Daisy Chain Mode

The board is prepared from hardware point of view for daisy chain mode configuration of more NCV705xx devices by means of resistors R3 and R4. By assembling zero ohm resistors, the basic connection of single IC is done. By combining two EVK boards, with help of signals MISO, MOSI, DO and DI available on test points, daisy chain connection of SPI data lines can be made. Other required signals can be easily connected in parallel via test points.

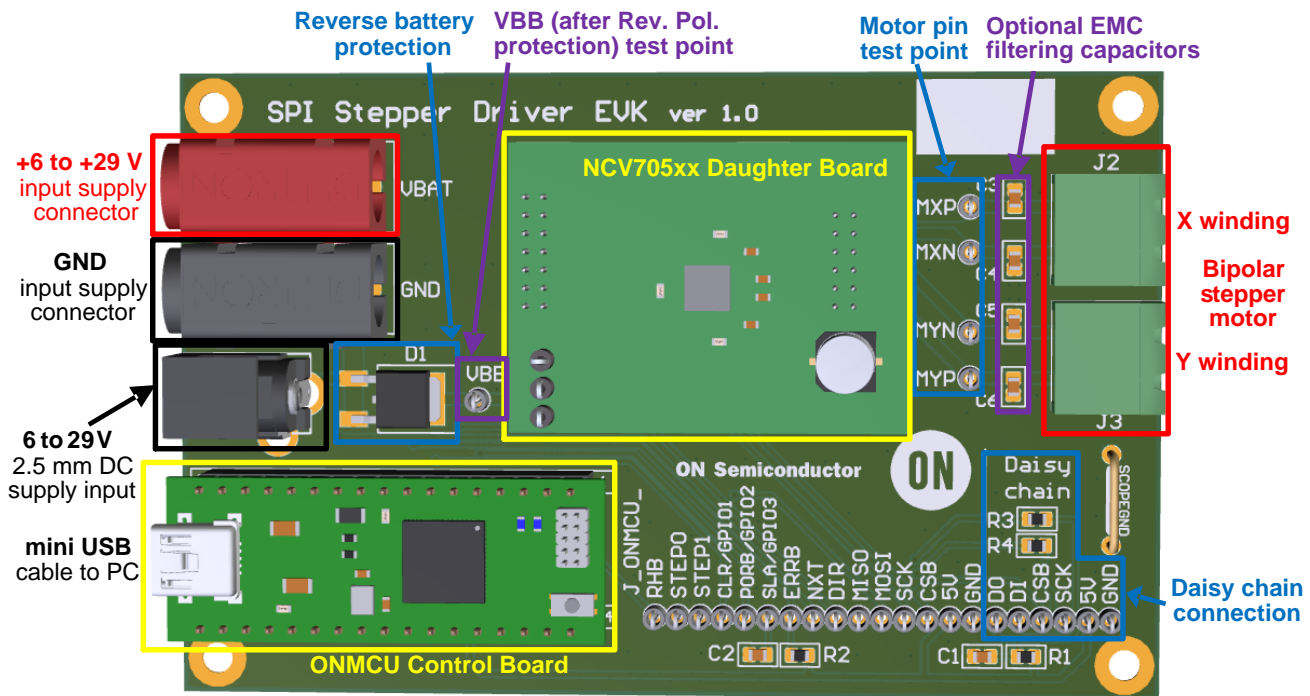

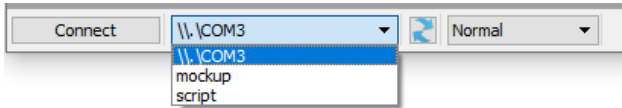

Figure 2. NCV705XXGEVK Micro-stepping Motor Driver Evaluation Board Picture

NCV705XXGEVK

Using of GUI SW

After connection of the battery supply and mini USB cable to the evaluation board, the button  in status bar should be used to relist all active virtual COM ports. From the list select COM port where evaluation board is connected. In case there is no real hardware available, the “Mockup” simulation mode can be selected to run the GUI SW.



After clicking “Connect” button, the successful connection status should be indicated in status bar:

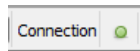

NCV705xx device used on daughter board has to be manually selected from the menu “Application” and “NCV705xx Register Access” window allowing access to all SPI registers and control of external signals will open, see dedicated chapter for more details.

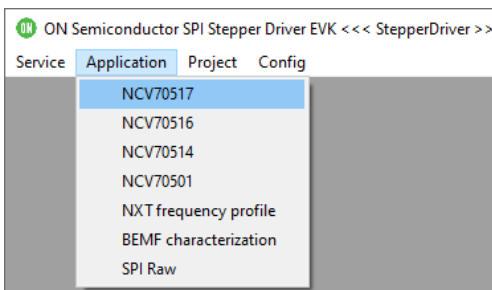

There is a possibility to use low level access where each bit in SPI frame can be controlled via “SPI Raw” panel. This allows to create non-standard frames for testing purposes (e.g. with corrupted parity).

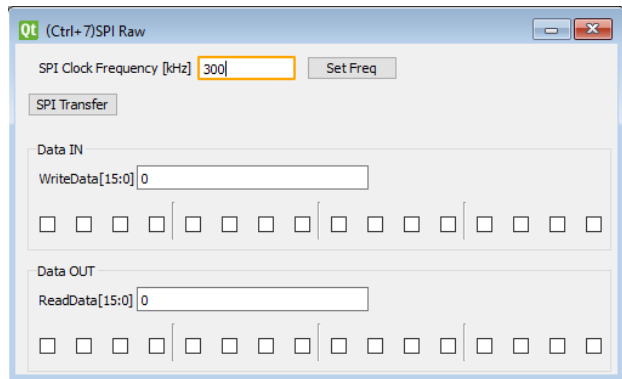

For debugging purposes, logging of the communication between GUI SW and Evaluation board can be useful. This can be enabled in menu “Project” by item “Logs”:

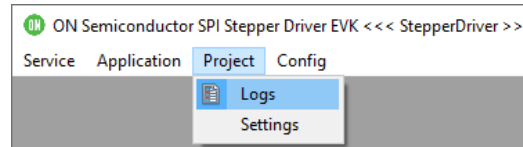

On the right side of the application area, the dedicated “Logs” window should appear:

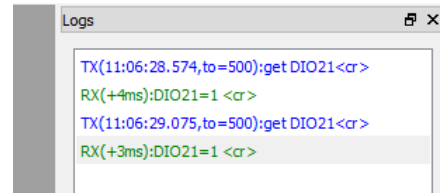

Logging of the ongoing commands can be then started/stopped by clicking check box “Log”:



Current state of the GUI SW including all control elements can be saved and restored in the “Config” menu.

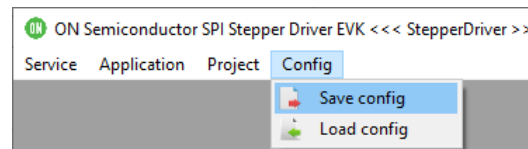

Please note that format of the number in any text box can be changed by clicking the right mouse button:

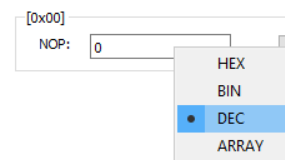

GUI SW framework allows to access and control all GUI elements in “NCV705xx Register Access” window from Python scripts. This can help with evaluation of the device significantly by automatizing many steps. For more details about Python scripting look for dedicated document.

NCV705XXGEVK

NCV705xx Register Access

In menu “Application” the correct NCV705xx device which is present on daughter board has to be selected and appropriate window will open. Window is split into two parts, on the left side the section for control of external pins is available and on the right side, all internal SPI registers

can be accessed. Status registers (Diagnostic) can be read out and Control registers (Motion parameters) can be written or read out. Button “Read All” serves to read content of whole SPI map.

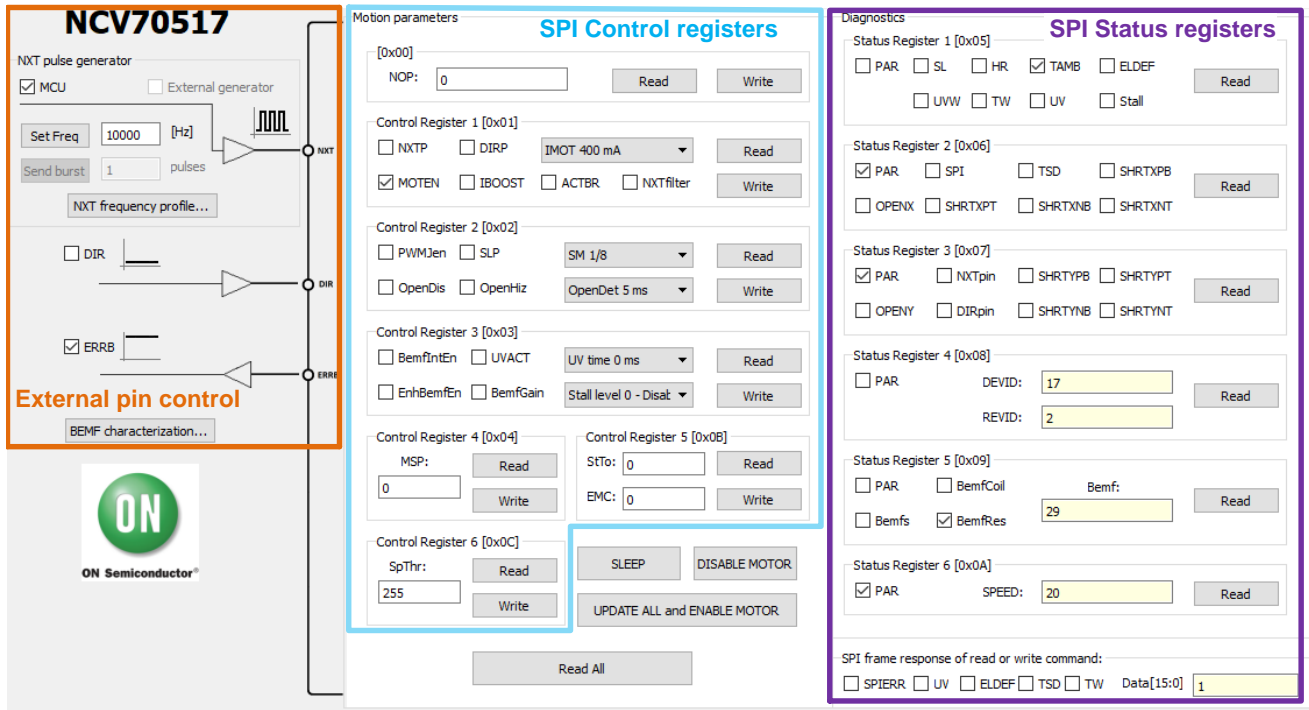

Figure 3. Basic NCV705xx Control Window

External Pin Control

External pins section allows to control all individual external pins of the device from GUI SW.

NXT pulses with accurate frequency can be provided from microcontroller when “MCU” check box is selected. When “External generator” check box is selected, the microcontroller’s IO pin is configured as input and NXT pulses can be provided from external source. There is also a possibility to send Burst of defined number of NXT pulses from microcontroller via writing required number into text box and clicking on “Send burst” button. On top of that, advanced “NXT frequency profile...” generator is available, for more details see dedicated chapter.

Please note, that on NCV70514 device, pins RHB, STEP1 and STEP0 need to be physically connected from mother board to daughter board by additional wires, these signals are not available on daughter board connectors from compatibility reasons. Control of these signals via SW GUI will not work without this patch.

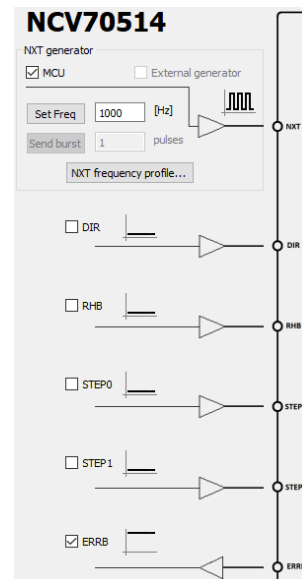

NCV705XXGEVK

NXT Pulse Generator

Beside the continuous sending of NXT pulses and sending Burst with defined number of NXT pulses, dedicated “NXT frequency profile” window exists and can be open either from “Application” menu or via “NXT frequency profile” button. Profile contains starting speed, acceleration phase, target speed, deceleration phase and end speed – any of which can be modified. Value is entered in Full Steps per second [FS/s] and according to selected step mode

recalculated to NXT frequency f_{NXT} . Please note that “Step Mode” in this window does not affect real Step mode programmed in the NCV705xx device, it serves just for recalculation of FS/s to f_{NXT} and resulting f_{NXT} is provided to NXT pin of the device. Number of full steps in each phase can be entered in bottom part of the window. Profile is then applied by “Send profile” button.

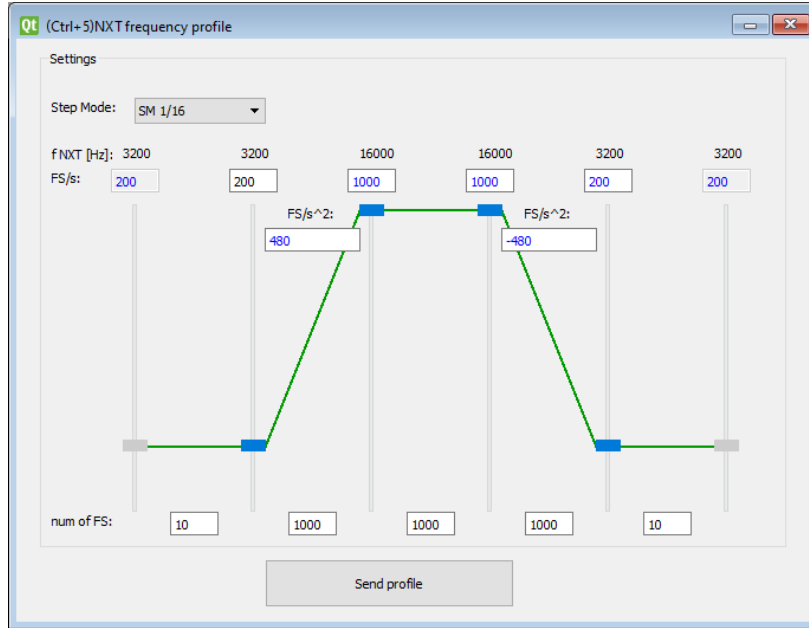

Figure 4. “NXT Frequency Profile” Window

BEMF Characterization Tool

Back electromotive force (Bemf) voltage generated by the stepper motor is directly related to the speed of the motor rotation. The voltage is measured by NCV705xx family devices and result is provided in SPI register. Bemf voltage can be used for Stall detection in the application. However detailed characterization is usually required (including speed, load, battery voltage, temperature).

BEMF characterization tool allows to characterize the setup and find resonant frequencies which should be avoided during operation. Speed of rotation can be swept in user defined range and at each speed the Bemf register is read out multiple times to obtain enough statistical data.

Steps to perform Bemf characterization:

1. NCV70517/NCV70514 device has to be setup with required parameters: set motor current

2. IMOT[3:0]/IRUN[3:0], select required Step mode in SM[2:0] register and enable H-bridge by MOTEN=1,
3. Set SpThr[7:0] register to 255, this will enable Bemf register reading for all speeds
4. In “BEMF characterization” window set required range of NXT pulse frequencies for the characterization and set the step in between
5. Select how many samples at each frequency should be read out
6. Click “Launch”, select folder where file with measured values should be saved.
7. Measured values become appearing in the graph area

NCV705XXGEVK

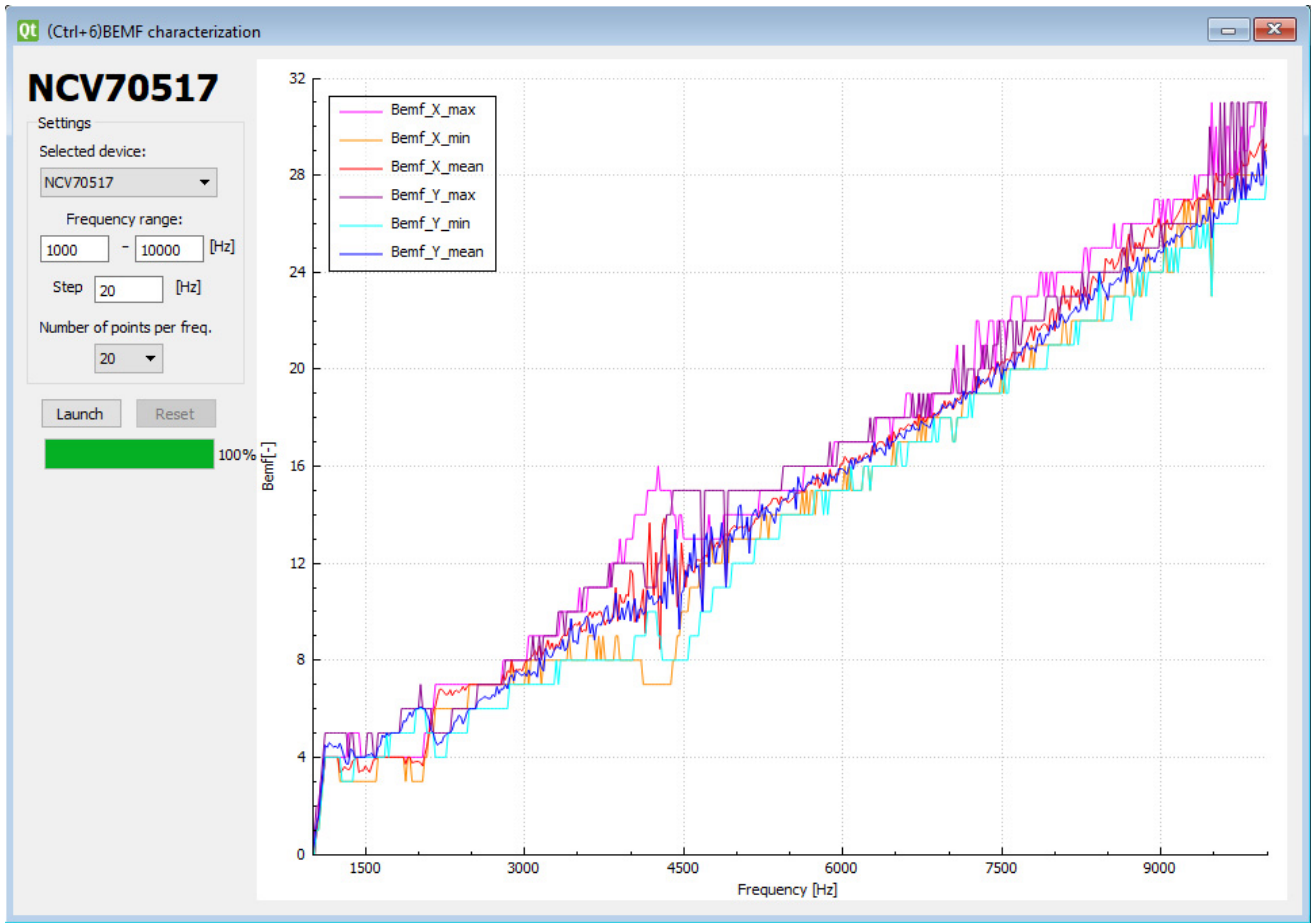
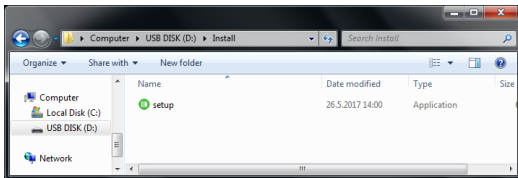

Figure 5. “BEMF Characterization” Window

Installation of GUI SW

In case the USB drivers for GUI SW are not yet present on PC, the following procedure should be used:

1. Run “setup.exe” installer:



2. Follow instructions and click Next button until finish:

a)

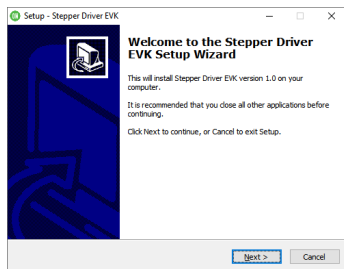

b)

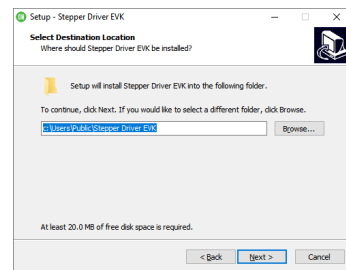

c)

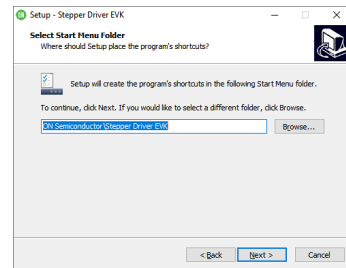

d)

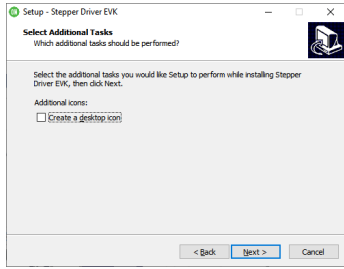

e)

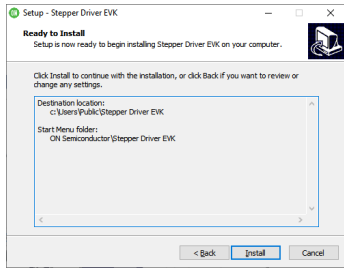

f)

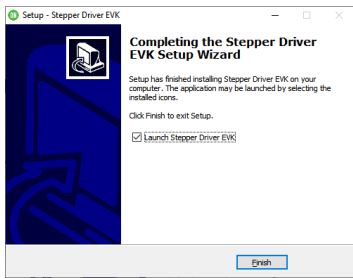

3. Connect USB mini cable to PC
4. Open Device Manager (Press Win+R and type *devmgmt.msc*)

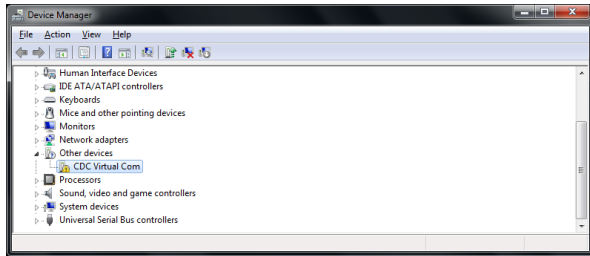

5. Update Driver of not correctly installed device "CDC Virtual Com" by Right button click and select "Update Driver Software"

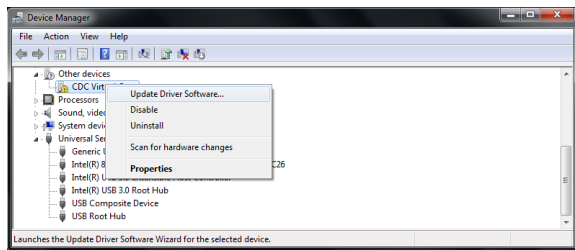

6. Select "Browse my computer..." then "Let me pick from a list..."

a)

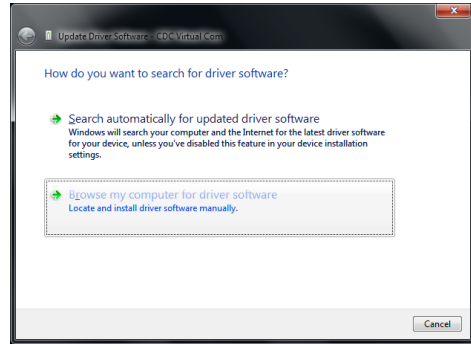

b)

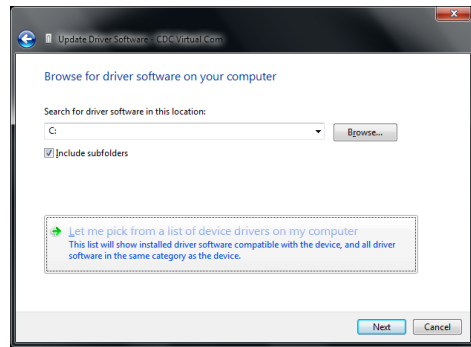

7. Click on "Next" then click on "Have Disk..."

a)

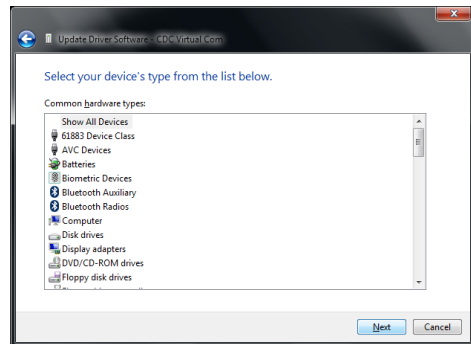

b)

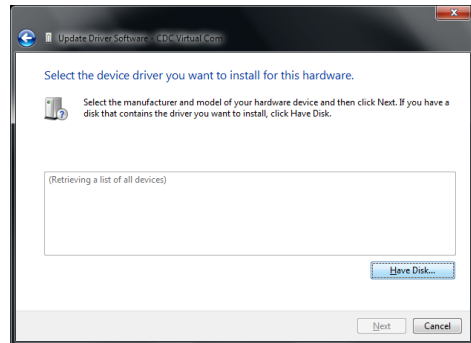

NCV705XXGEVK

8. Click on “Browse” and select path to driver – default location is “C:\Users\Public\Stepper Driver EVK\driver” if not changed during GUI SW installation

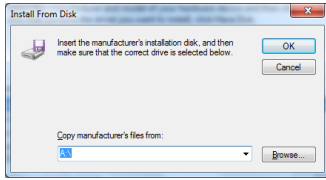

9. Click on “OK”, “Next” and “Install”
a)

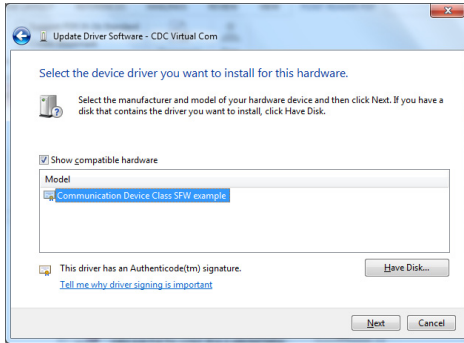

b)

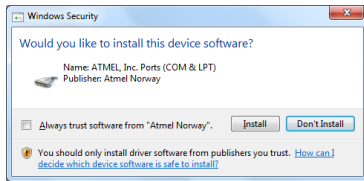

10. Finish USB Driver update by click on “Close”

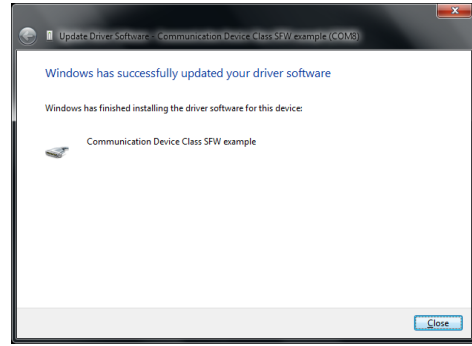

11. Verify COM port device “Communication Device Class SFW example”

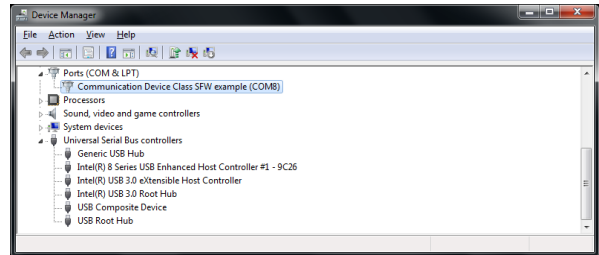

NCV705XXGEVK

Evaluation Board Schematic

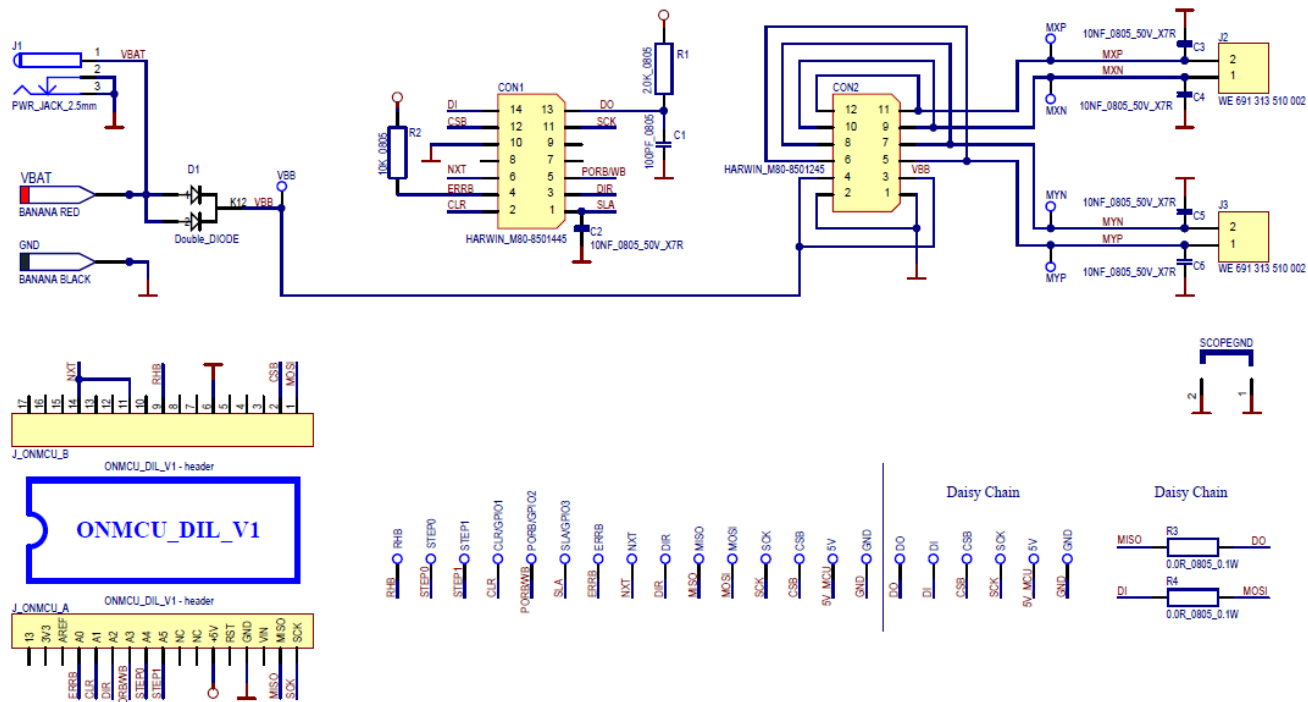

Figure 6. Schematic of SPI Stepper Driver EVK Mother Board

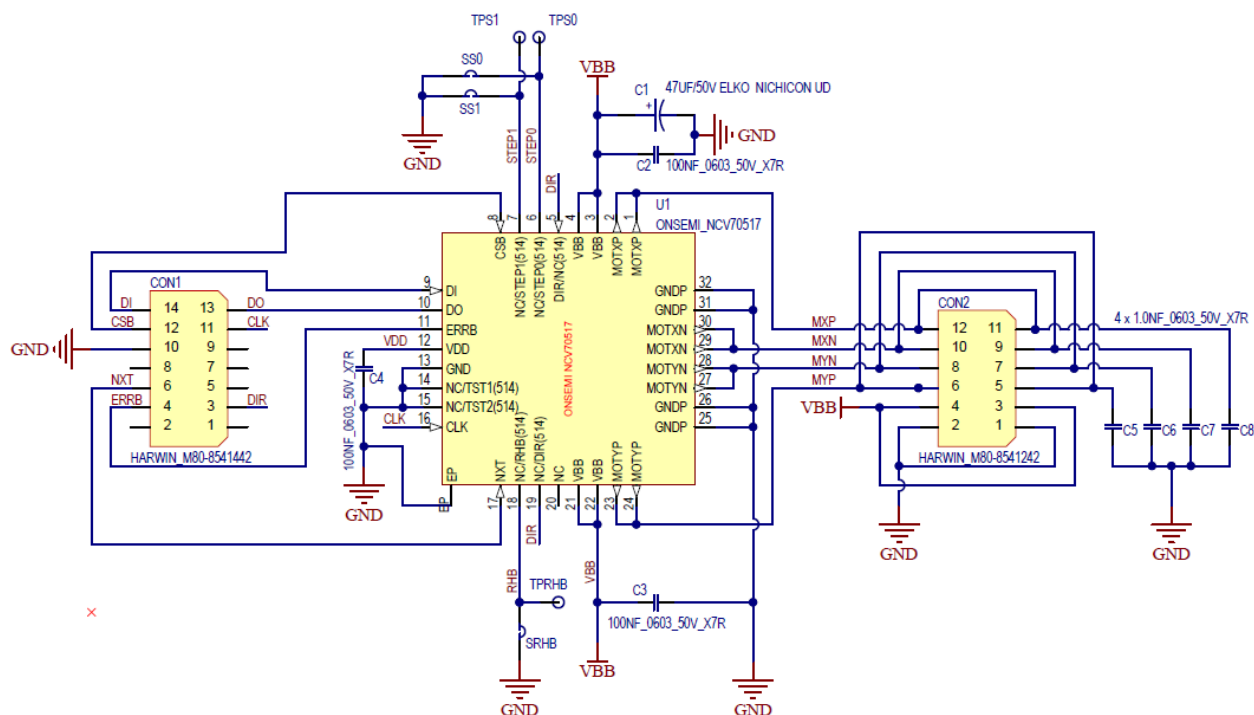

Figure 7. Schematic of NCV70517/NCV70514 Daughter Board

onsemi, **Onsemi**, and other names, marks, and brands are registered and/or common law trademarks of Semiconductor Components Industries, LLC dba "**onsemi**" or its affiliates and/or subsidiaries in the United States and/or other countries. **onsemi** owns the rights to a number of patents, trademarks, copyrights, trade secrets, and other intellectual property. A listing of **onsemi**'s product/patent coverage may be accessed at www.onsemi.com/site/pdf/Patent-Marking.pdf. **onsemi** is an Equal Opportunity/Affirmative Action Employer. This literature is subject to all applicable copyright laws and is not for resale in any manner.

The evaluation board/kit (research and development board/kit) (hereinafter the "board") is not a finished product and is not available for sale to consumers. The board is only intended for research, development, demonstration and evaluation purposes and will only be used in laboratory/development areas by persons with an engineering/technical training and familiar with the risks associated with handling electrical/mechanical components, systems and subsystems. This person assumes full responsibility/liability for proper and safe handling. Any other use, resale or redistribution for any other purpose is strictly prohibited.

THE BOARD IS PROVIDED BY ONSEMI TO YOU "AS IS" AND WITHOUT ANY REPRESENTATIONS OR WARRANTIES WHATSOEVER. WITHOUT LIMITING THE FOREGOING, ONSEMI (AND ITS LICENSORS/SUPPLIERS) HEREBY DISCLAIMS ANY AND ALL REPRESENTATIONS AND WARRANTIES IN RELATION TO THE BOARD, ANY MODIFICATIONS, OR THIS AGREEMENT, WHETHER EXPRESS, IMPLIED, STATUTORY OR OTHERWISE, INCLUDING WITHOUT LIMITATION ANY AND ALL REPRESENTATIONS AND WARRANTIES OF MERCHANTABILITY, FITNESS FOR A PARTICULAR PURPOSE, TITLE, NON-INFRINGEMENT, AND THOSE ARISING FROM A COURSE OF DEALING, TRADE USAGE, TRADE CUSTOM OR TRADE PRACTICE.

onsemi reserves the right to make changes without further notice to any board.

You are responsible for determining whether the board will be suitable for your intended use or application or will achieve your intended results. Prior to using or distributing any systems that have been evaluated, designed or tested using the board, you agree to test and validate your design to confirm the functionality for your application. Any technical, applications or design information or advice, quality characterization, reliability data or other services provided by **onsemi** shall not constitute any representation or warranty by **onsemi**, and no additional obligations or liabilities shall arise from **onsemi** having provided such information or services.

onsemi products including the boards are not designed, intended, or authorized for use in life support systems, or any FDA Class 3 medical devices or medical devices with a similar or equivalent classification in a foreign jurisdiction, or any devices intended for implantation in the human body. You agree to indemnify, defend and hold harmless **onsemi**, its directors, officers, employees, representatives, agents, subsidiaries, affiliates, distributors, and assigns, against any and all liabilities, losses, costs, damages, judgments, and expenses, arising out of any claim, demand, investigation, lawsuit, regulatory action or cause of action arising out of or associated with any unauthorized use, even if such claim alleges that **onsemi** was negligent regarding the design or manufacture of any products and/or the board.

This evaluation board/kit does not fall within the scope of the European Union directives regarding electromagnetic compatibility, restricted substances (RoHS), recycling (WEEE), FCC, CE or UL, and may not meet the technical requirements of these or other related directives.

FCC WARNING – This evaluation board/kit is intended for use for engineering development, demonstration, or evaluation purposes only and is not considered by **onsemi** to be a finished end product fit for general consumer use. It may generate, use, or radiate radio frequency energy and has not been tested for compliance with the limits of computing devices pursuant to part 15 of FCC rules, which are designed to provide reasonable protection against radio frequency interference. Operation of this equipment may cause interference with radio communications, in which case the user shall be responsible, at its expense, to take whatever measures may be required to correct this interference.

onsemi does not convey any license under its patent rights nor the rights of others.

LIMITATIONS OF LIABILITY: **onsemi** shall not be liable for any special, consequential, incidental, indirect or punitive damages, including, but not limited to the costs of requalification, delay, loss of profits or goodwill, arising out of or in connection with the board, even if **onsemi** is advised of the possibility of such damages. In no event shall **onsemi**'s aggregate liability from any obligation arising out of or in connection with the board, under any theory of liability, exceed the purchase price paid for the board, if any.

The board is provided to you subject to the license and other terms per **onsemi**'s standard terms and conditions of sale. For more information and documentation, please visit www.onsemi.com.

ADDITIONAL INFORMATION

TECHNICAL PUBLICATIONS:

Technical Library: www.onsemi.com/design/resources/technical-documentation
onsemi Website: www.onsemi.com

ONLINE SUPPORT: www.onsemi.com/support

For additional information, please contact your local Sales Representative at www.onsemi.com/support/sales