

ON Semiconductor

Is Now

onsemi™

To learn more about onsemi™, please visit our website at
www.onsemi.com

onsemi and **onsemi** and other names, marks, and brands are registered and/or common law trademarks of Semiconductor Components Industries, LLC dba "**onsemi**" or its affiliates and/or subsidiaries in the United States and/or other countries. **onsemi** owns the rights to a number of patents, trademarks, copyrights, trade secrets, and other intellectual property. A listing of **onsemi** product/patent coverage may be accessed at www.onsemi.com/site/pdf/Patent-Marking.pdf. **onsemi** reserves the right to make changes at any time to any products or information herein, without notice. The information herein is provided "as-is" and **onsemi** makes no warranty, representation or guarantee regarding the accuracy of the information, product features, availability, functionality, or suitability of its products for any particular purpose, nor does **onsemi** assume any liability arising out of the application or use of any product or circuit, and specifically disclaims any and all liability, including without limitation special, consequential or incidental damages. Buyer is responsible for its products and applications using **onsemi** products, including compliance with all laws, regulations and safety requirements or standards, regardless of any support or applications information provided by **onsemi**. "Typical" parameters which may be provided in **onsemi** data sheets and/or specifications can and do vary in different applications and actual performance may vary over time. All operating parameters, including "Typicals" must be validated for each customer application by customer's technical experts. **onsemi** does not convey any license under any of its intellectual property rights nor the rights of others. **onsemi** products are not designed, intended, or authorized for use as a critical component in life support systems or any FDA Class 3 medical devices or medical devices with a same or similar classification in a foreign jurisdiction or any devices intended for implantation in the human body. Should Buyer purchase or use **onsemi** products for any such unintended or unauthorized application, Buyer shall indemnify and hold **onsemi** and its officers, employees, subsidiaries, affiliates, and distributors harmless against all claims, costs, damages, and expenses, and reasonable attorney fees arising out of, directly or indirectly, any claim of personal injury or death associated with such unintended or unauthorized use, even if such claim alleges that **onsemi** was negligent regarding the design or manufacture of the part. **onsemi** is an Equal Opportunity/Affirmative Action Employer. This literature is subject to all applicable copyright laws and is not for resale in any manner. Other names and brands may be claimed as the property of others.

NCP171AMX250245TCG LDO Regulator, with Dual Power Mode demoboard

Demo Board Description

The demoboard supports the LDO regulator NCP171 in XDFN4 1.2 x1.2 mm package with fixed output voltage 2.5 V in Active mode and 2.45 V in Low Power mode. The Ultra Low Consumption typically below 50 nA in Low Power mode ensures long battery life with maximum output current up to 5 mA. The device in Active mode with maximum current up to 80 mA has excellent transient response suitable especially for wireless communication applications. ENABLE function allows turn off the output voltage and the device is available with or without active discharge feature.

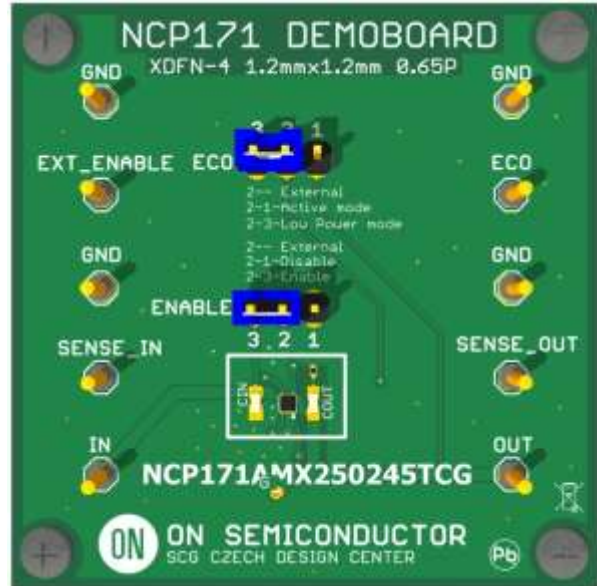

Size: 50mm x 50mm x 12mm

Features and Applications

Features

- Operating Input Voltage Range: 1.7 V to 5.5 V
- Output Voltage Range: 0.6 V to 3.3 V (50 mV steps)
- Low Power Mode / Active Mode Externally Controlled by ECO pin
- Internally Factory Programmable Output Voltage Offset for Low Power/Active Mode to 50 mV, 100 mV, 150 mV, 200 mV
- Quiescent Current of 50 nA at No Load, (Low Power mode)
- Low Dropout: 41 mV Typ. at 80 mA ($V_{out} = 3.3$ V)
- $\pm 2\%$ Output Voltage Accuracy in Active Mode
- High PSRR: 65 dB at 1 kHz in Active Mode
- Active Output Discharge for Fast Output Turn-Off
- Current Limitation, Thermal Shutdown
- Available in Small XDFN4 1.2x1.2 Package
- These are Pb-Free Devices

Applications

- IoT
- RFID
- Portable Communication Equipment
- Consumer Electronics