

Schematic for the NCP170AXV330GEVB Evaluation Board

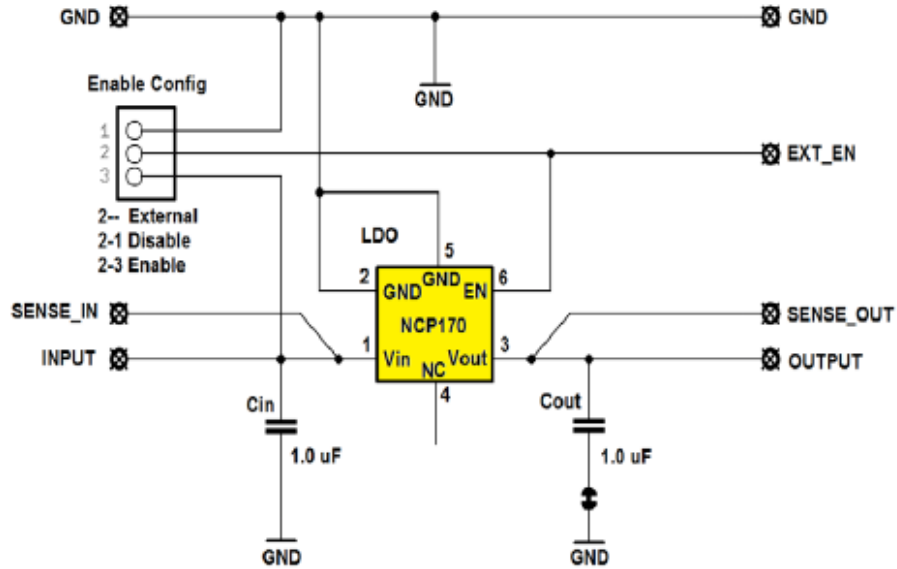

Programming I/F

