

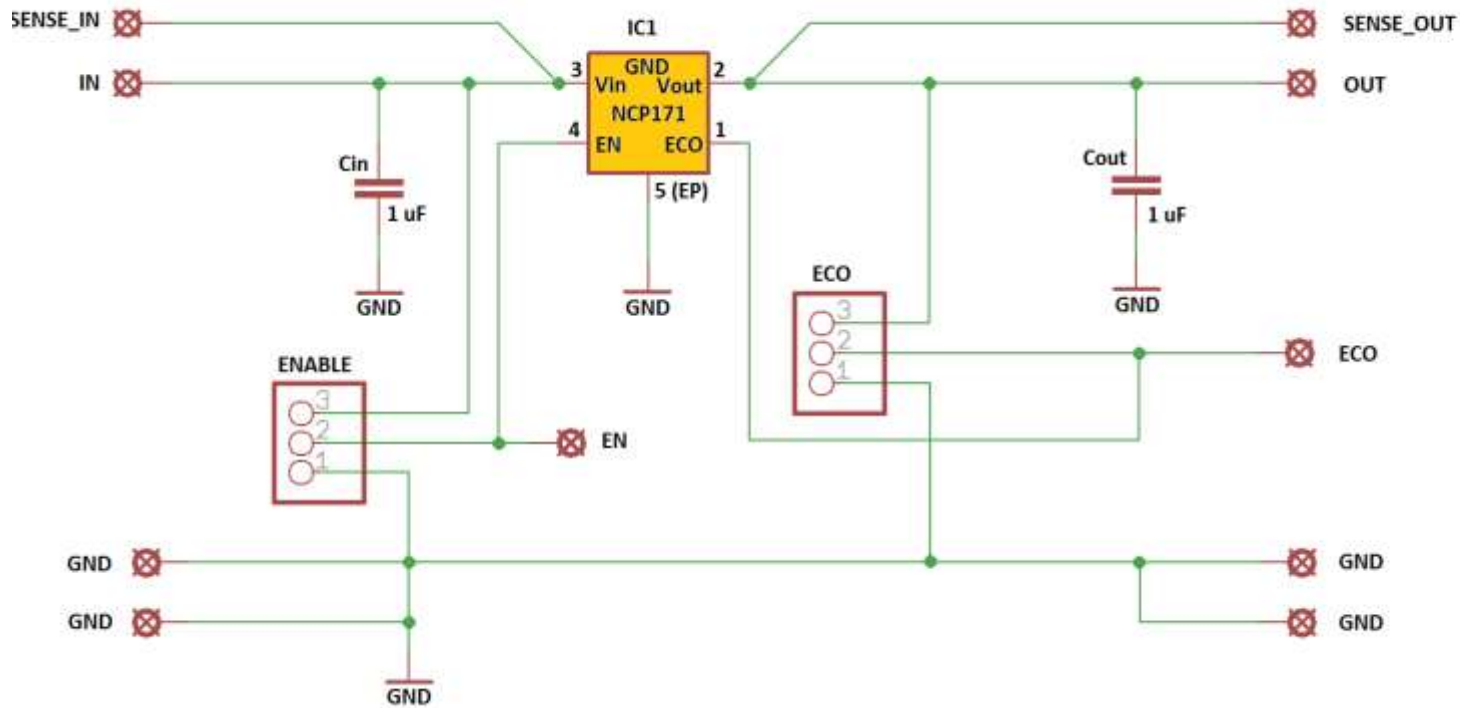

ON Semiconductor

Schematic for the NCP171AMX250245TCG LDO Demoboard



Programming I/F

