

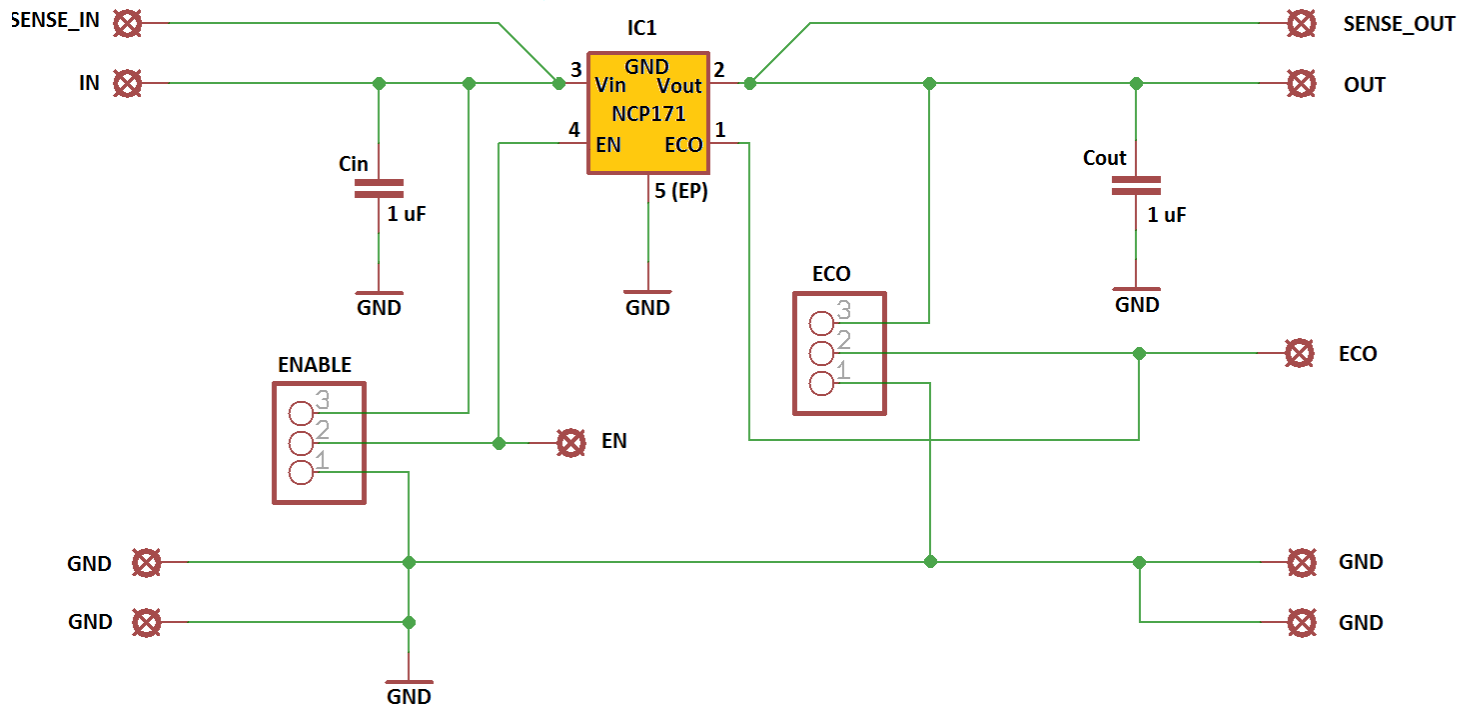

ON Semiconductor

Schematic for the NCP171AMX330310TCG LDO Demoboard



Programming I/F

