



## Test Procedure for the NCP137AFCT120T2G Demo Board

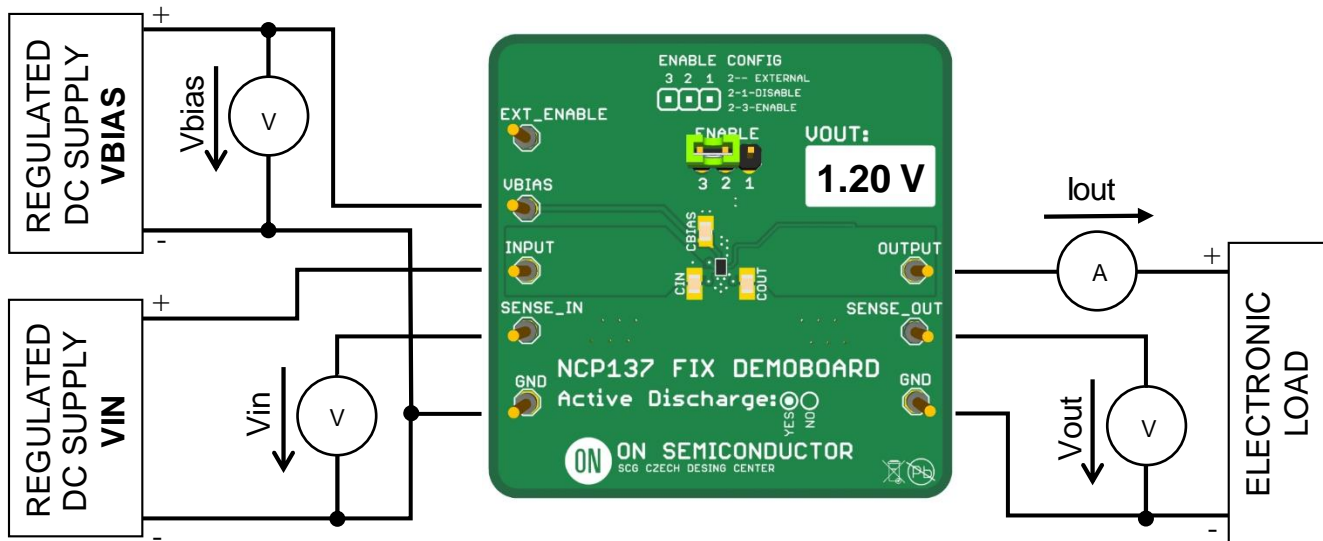

Figure 1: Test Setup

### Test Procedure

1. Connect the test setup as shown in Figure 1.
2. Apply supply voltage  $V_{bias} = 5.5\text{ V}$
3. Apply supply voltage  $V_{in} = 1.5\text{ V}$
4. Apply  $I_{out} = 10\text{ mA}$  load.
5. Check the Output Voltage  $V_{out} = 1.2\text{V} \pm 1\%$
6. Increase  $I_{out}$  load current to  $0.7\text{ A}$
7. Check the Output Voltage  $V_{out} = 1.2\text{V} \pm 1\%$
8. Power down the load
9. Power down  $V_{in}$  and  $V_{bias}$  supply
10. End of test