

XGS 5000, XGS 3000 and XGS 2000 Global Shutter CMOS Image Sensors

XGS Family

Description

The XGS CMOS image sensor family provides high performance global shutter image capture. The family comes in different resolutions in a single package: 2, 3 and 5 MP with up to 2/3-inch optical format. The 16 mm x 16 mm package makes the XGS family particularly suited for integration in 29 mm x 29 mm camera formats. The high speed, 12-bit output maximally leverages interfaces such as USB 3.2, Thunderbolt™ 2 and 10 GigE.

Image data is read out through a column ADC architecture and then transferred over a HiSPi interface. On-chip logic, programmable via the serial interface, generates internal timing for integration and readout control. Up to three register configurations can be programmed and sequentially enabled (frame by frame) using a single command over the control interface.

Table 1. KEY PERFORMANCE PARAMETERS

Parameter	Typical Value	
Optical Format	XGS 5000	2/3-inch (10.6 mm Diagonal)
	XGS 3000	1/2-inch (8.2 mm Diagonal)
	XGS 2000	1/2.2-inch (7.3 mm Diagonal)
Active Pixels	XGS 5000	2592 (H) x 2048 (V)
	XGS 3000	2048 (H) x 1536 (V)
	XGS 2000	1920 (H) x 1200 (V)
Pixel Size	3.2 μm	
Color Filter Array	Monochrome, Bayer	
Shutter Type	Global Shutter	
Input Clock	32.4 MHz	
Output Interface	HiSPi (16 Lanes – 777.6 Mbps/lane)	
Frame Rate (12-bit)	16 Lanes (–X4)	
	XGS 5000	132
	XGS 3000	175
	XGS 2000	220
	4 Lanes (–X5)	
	XGS 5000	43
Read Noise	4 e– (1x), 1.9 e– (4x)	
SNR _{MAX}	40 dB	
Dynamic Range	68 dB	
Supply Voltages	1.2 V, 2.8 V, 3 V (0.4 V, 1.8 V Optional)	
Power Consumption	0.75 W	
Operating Temp.	–40°C to 85°C (Junction)	
Package	163-pin iLGA (Inspectable Land Grid Array)	

ORDERING INFORMATION

See detailed ordering and shipping information on page 2 of this data sheet.

Public Data Sheet

Interested in what you see? If you would like more detailed information, please request the full version of our data sheet.

[Request Full Data Sheet](#)

Features

- On-chip 12-bit Column ADCs
- 10-bit Mode with Increased Frame Rate of 148 fps (16-lane) at Full Resolution
- Companding & 10-Bit Mode at 100 fps (8-lane) and 50 fps (8-lane)
- Dual Gain Mode with 74.5 dB Dynamic Range (T_J = 40°C) at Half Frame Rate
- Data Interface: 16-lane HiSPi (Scalable Low-Voltage Signaling)
- Configurable Number of HiSPi Lanes: 16, 12, 8 or 4 Lanes
- Two-Wire (I2C) and Four-Wire (SPI) Serial Interface
- Triggered Integration and Readout Control
- Programmable Control for up to 8 Regions of Interest (ROI)
- Context Switching
- These Devices are Pb-Free, Halogen Free/BFR Free and are RoHS Compliant

Applications

- Machine Vision
- Security
- Intelligent Transportation Systems (ITS)
- Broadcasting
- Medical
- Scientific

XGS Family

Table 2. ORDERABLE PART NUMBERS (Note 2)

Part Number	Product Description				Speed Grade	Resolution (H x V)
NOIX4SN5000B-LTI	5 MP	Mono	Production device	0° CRA	16 Lanes	2592 x 2048
NOIX4SE5000B-LTI	5 MP	Color	Production device	0° CRA		
NOIX4SF5000B-LTI	5 MP	Color	Production device	4.7° CRA		
NOIX5SN5000B-LTI	5 MP	Mono	Production device	0° CRA	4 Lanes	
NOIX5SE5000B-LTI	5 MP	Color	Production device	0° CRA		

NOIX4SF3000B-LTI	3 MP	Color	Production device	4.7° CRA	16 Lanes	2048 x 1536
NOIX4SP3000B-LTI	3 MP	Mono	Production device	4.7° CRA		

NOIX4SN2000B-LTI	2 MP	Mono	Production device	0° CRA	16 Lanes	1920 x 1200
NOIX4SE2000B-LTI	2 MP	Color	Production device	0° CRA		

1. Production Device part numbers are listed for informational purpose only. Production Device part numbers are not available for orders at this time. Please contact **onsemi** for availability dates.
2. See the **onsemi** Device Nomenclature document (TND310/D) for a full description of the naming convention used for image sensors. For reference documentation, including information on evaluation kits, please visit our web site at www.onsemi.com.

Table 3. ORDERING INFORMATION EVALUATION KITS

Part Number	Product Description	Additional Information
NOIX4SN5000KBLFB-GEVB	Sensor Headboard (5 MP, Mono, 16-Lane)	Demo Kit Headboard (incl. NOIX4SN5000KB-LTI) (Note 3)
NOIX4SE5000KBLFB-GEVB	Sensor Headboard (5 MP, Color, 16-Lane)	Demo Kit Headboard (incl. NOIX4SE5000KB-LTI) (Note 3)
AGBAN6CS-GEVK	Frame Buffer Demo Board	AP21088 including Power Adapter
AGB1N0CS-GEVK	Demo 3 Board	FPGA Base Board including USB Cable and Tripod

3. Sensors are soldered to the headboard.

XGS Family

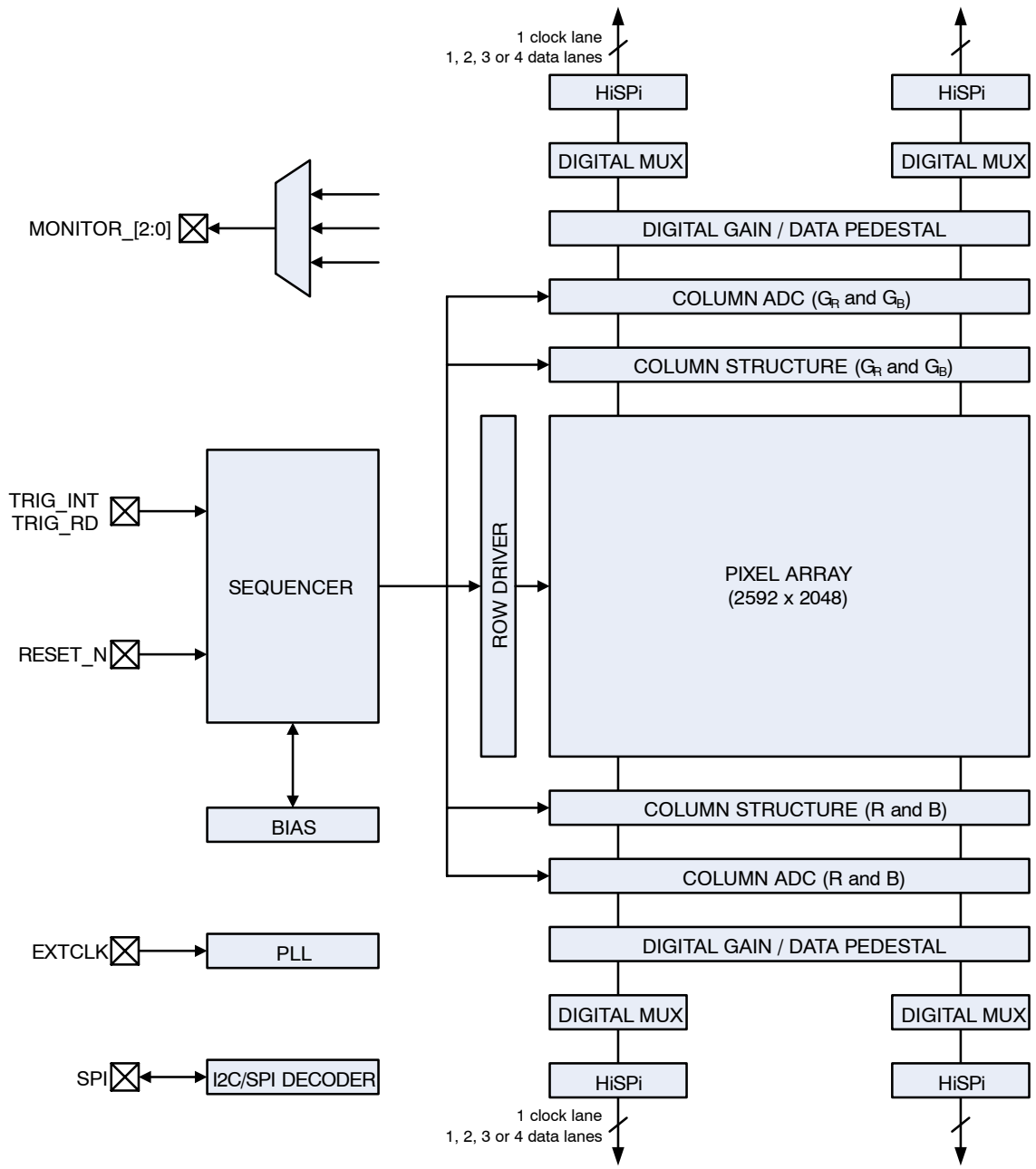
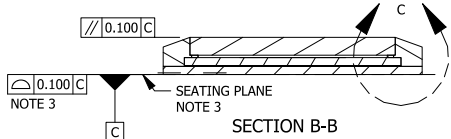
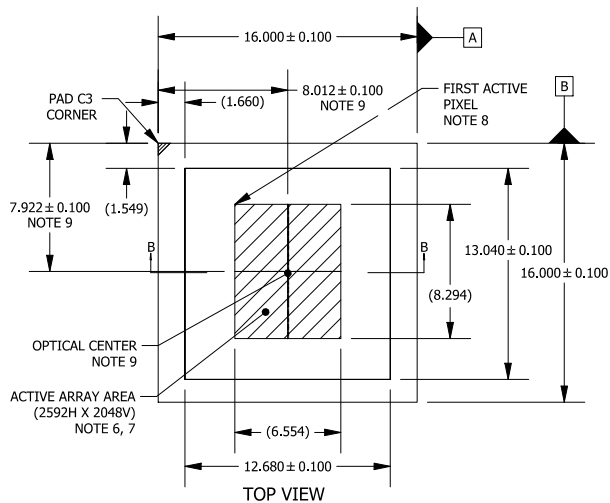

Figure 1. Functional Block Diagram (XGS 5000)

Thunderbolt and the Thunderbolt logo are trademarks of Intel Corporation or its subsidiaries in the U.S. and/or other countries.

ILGA163 16x16
CASE 710AB
ISSUE D

DATE 03 JUN 2022



NOTES

1. DIMENSIONING AND TOLERANCING PER ASME Y14.5M, 1994.
2. CONTROLLING DIMENSION: MILLIMETERS [mm].
3. COPLANARITY APPLIES TO THE PLATED LAND PADS.
4. GLASS: 1.100 THICKNESS; REFRACTIVE INDEX = 1.52.
5. AIR GAP BETWEEN GLASS AND PIXEL ARRAY: 0.150 THICKNESS.
6. PARALLELISM APPLIES ONLY TO THE ACTIVE ARRAY.
7. MAXIMUM ROTATION OF ACTIVE ARRAY RELATIVE TO DATUMS A AND B IS $\pm 1^\circ$.
8. REFER TO THE DEVICE DATA SHEET FOR TOTAL PIXEL ARRAY DEFINITIONS.
9. OPTICAL CENTER RELATIVE TO PACKAGE CENTER (X, Y) = (0.012, 0.078).
10. PACKAGE CENTER (X, Y) = (0.000, 0.000).

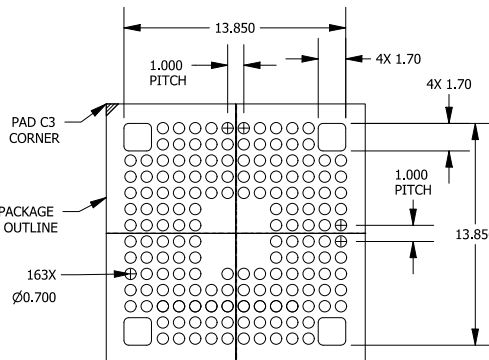
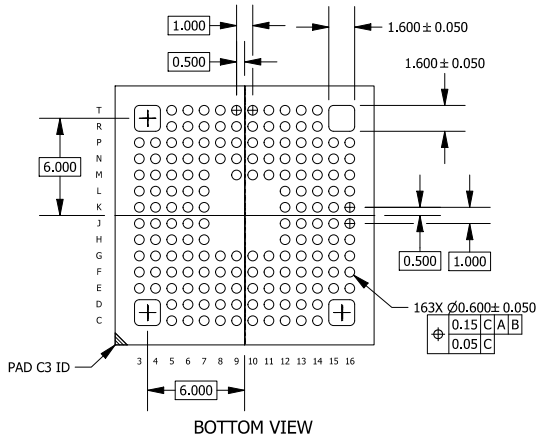
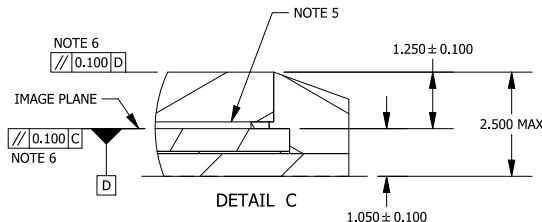

RECOMMENDED MOUNTING FOOTPRINT*

*FOR ADDITIONAL INFORMATION ON OUR Pb-FREE STRATEGY AND SOLDERING DETAILS, PLEASE DOWNLOAD THE ON SEMICONDUCTOR SOLDERING AND MOUNTING TECHNIQUES REFERENCE MANUAL, SOLDERRM/D.

GENERIC MARKING DIAGRAM*

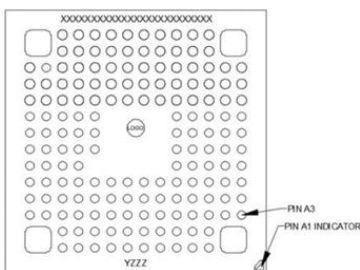

XXXX = Specific Device Code
Y = Year
ZZZ = Assembly Lot Code

*This information is generic. Please refer to device data sheet for actual part marking. Pb-Free indicator, "G" or microdot "▪", may or may not be present. Some products may not follow the Generic Marking.

DOCUMENT NUMBER:	98AON06576H	Electronic versions are uncontrolled except when accessed directly from the Document Repository. Printed versions are uncontrolled except when stamped "CONTROLLED COPY" in red.
DESCRIPTION:	ILGA163 16x16	PAGE 1 OF 1

onsemi and ONSEMI are trademarks of Semiconductor Components Industries, LLC dba onsemi or its subsidiaries in the United States and/or other countries. onsemi reserves the right to make changes without further notice to any products herein. onsemi makes no warranty, representation or guarantee regarding the suitability of its products for any particular purpose, nor does onsemi assume any liability arising out of the application or use of any product or circuit, and specifically disclaims any and all liability, including without limitation special, consequential or incidental damages. onsemi does not convey any license under its patent rights nor the rights of others.

onsemi, **Onsemi**, and other names, marks, and brands are registered and/or common law trademarks of Semiconductor Components Industries, LLC dba "**onsemi**" or its affiliates and/or subsidiaries in the United States and/or other countries. **onsemi** owns the rights to a number of patents, trademarks, copyrights, trade secrets, and other intellectual property. A listing of **onsemi**'s product/patent coverage may be accessed at www.onsemi.com/site/pdf/Patent-Marking.pdf. **onsemi** reserves the right to make changes at any time to any products or information herein, without notice. The information herein is provided "as-is" and **onsemi** makes no warranty, representation or guarantee regarding the accuracy of the information, product features, availability, functionality, or suitability of its products for any particular purpose, nor does **onsemi** assume any liability arising out of the application or use of any product or circuit, and specifically disclaims any and all liability, including without limitation special, consequential or incidental damages. Buyer is responsible for its products and applications using **onsemi** products, including compliance with all laws, regulations and safety requirements or standards, regardless of any support or applications information provided by **onsemi**. "Typical" parameters which may be provided in **onsemi** data sheets and/or specifications can and do vary in different applications and actual performance may vary over time. All operating parameters, including "Typicals" must be validated for each customer application by customer's technical experts. **onsemi** does not convey any license under any of its intellectual property rights nor the rights of others. **onsemi** products are not designed, intended, or authorized for use as a critical component in life support systems or any FDA Class 3 medical devices or medical devices with a same or similar classification in a foreign jurisdiction or any devices intended for implantation in the human body. Should Buyer purchase or use **onsemi** products for any such unintended or unauthorized application, Buyer shall indemnify and hold **onsemi** and its officers, employees, subsidiaries, affiliates, and distributors harmless against all claims, costs, damages, and expenses, and reasonable attorney fees arising out of, directly or indirectly, any claim of personal injury or death associated with such unintended or unauthorized use, even if such claim alleges that **onsemi** was negligent regarding the design or manufacture of the part. **onsemi** is an Equal Opportunity/Affirmative Action Employer. This literature is subject to all applicable copyright laws and is not for resale in any manner.

ADDITIONAL INFORMATION

TECHNICAL PUBLICATIONS:

Technical Library: www.onsemi.com/design/resources/technical-documentation
onsemi Website: www.onsemi.com

ONLINE SUPPORT: www.onsemi.com/support

For additional information, please contact your local Sales Representative at www.onsemi.com/support/sales