

Bipolar Transistor

50 V, 2 A, Low $V_{CE(sat)}$, NPN Single

2SC5994

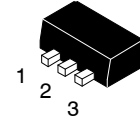

SOT-89 / PCP-1
CASE 419AU

Features

- Adoption of MBIT Process
- Low Collector to Emitter Saturation Voltage
- Large Current Capacity
- High Speed Switching

Applications

- Voltage Regulators
- Relay Drivers
- Lamp Drivers
- Electrical Equipment

SPECIFICATIONS

ABSOLUTE MAXIMUM RATINGS at $T_a = 25^\circ\text{C}$

Parameter	Symbol	Value	Unit
Collector to Base Voltage	V_{CBO}	100	V
Collector to Emitter Voltage	V_{CES}	100	V
	V_{CEO}	50	V
Emitter to Base Voltage	V_{EBO}	6	V
Collector Current	I_C	2	A
Collector Current (Pulse)	I_{CP}	4	A
Base Current	I_B	400	mA
Collector Dissipation (Note 1) $T_C = 25^\circ\text{C}$	P_C	1.3	W
		3.5	
Junction Temperature	T_J	150	$^\circ\text{C}$
Storage Temperature	T_{STG}	-55 to +150	$^\circ\text{C}$

Stresses exceeding those listed in the Maximum Ratings table may damage the device. If any of these limits are exceeded, device functionality should not be assumed, damage may occur and reliability may be affected.

1. Surface mounted on ceramic substrate (450 mm² x 0.8 mm).

ELECTRICAL CONNECTION

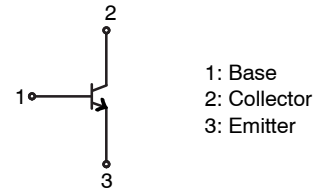

MARKING DIAGRAM

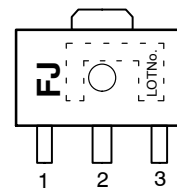

FJ = Specific Device Code

ORDERING INFORMATION

Device	Package	Shipping [†]
2SC5994-TD-E	SOT-89 / PCP-1	1000 / Tape & Reel

[†]For information on tape and reel specifications, including part orientation and tape sizes, please refer to our Tape and Reel Packaging Specifications Brochure, [BRD8011/D](#).

2SC5994

ELECTRICAL CHARACTERISTICS at $T_A = 25^\circ\text{C}$

Parameter	Symbol	Conditions	Value			Unit
			Min	Typ	Max	
Collector Cutoff Current	I_{CBO}	$V_{CB} = 50\text{ V}, I_E = 0\text{ A}$			1	μA
Emitter Cutoff Current	I_{EBO}	$V_{EB} = 4\text{ V}, I_C = 0\text{ A}$			1	μA
DC Current Gain	h_{FE1}	$V_{CE} = 2\text{ V}, I_C = 100\text{ mA}$	200		560	
	h_{FE2}	$V_{CE} = 2\text{ V}, I_C = 1.5\text{ A}$	40			
Gain-Bandwidth Product	f_T	$V_{CE} = 10\text{ V}, I_C = 300\text{ mA}$		420		MHz
Output Capacitance	C_{ob}	$V_{CB} = 10\text{ V}, f = 1\text{ MHz}$		9		pF
Collector to Emitter Saturation Voltage	$V_{CE(sat)}$	$I_C = 1\text{ A}, I_B = 50\text{ mA}$		135	300	mV
Base to Emitter Saturation Voltage	$V_{BE(sat)}$	$I_C = 1\text{ A}, I_B = 50\text{ mA}$		0.9	1.2	V
Collector to Base Breakdown Voltage	$V_{(BR)CBO}$	$I_C = 10\text{ }\mu\text{A}, I_E = 0\text{ A}$	100			V
Collector to Emitter Breakdown Voltage	$V_{(BR)CES}$	$I_C = 100\text{ }\mu\text{A}, R_{BE} = 0\text{ }\Omega$	100			V
	$V_{(BR)CEO}$	$I_C = 1\text{ mA}, R_{BE} = \infty$	50			V
Emitter to Base Breakdown Voltage	$V_{(BR)EBO}$	$I_E = 10\text{ }\mu\text{A}, I_C = 0\text{ A}$	6			V
Turn-On Time	t_{on}	See specified Test Circuit		30		ns
Storage Time	t_{stg}			330		ns
Fall Time	t_f			40		ns

Product parametric performance is indicated in the Electrical Characteristics for the listed test conditions, unless otherwise noted. Product performance may not be indicated by the Electrical Characteristics if operated under different conditions.

Switching Time Test Circuit

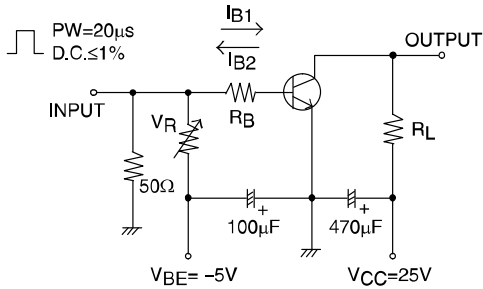

$$I_C = 10\text{ mA}, I_{B1} = -10\text{ mA}, I_{B2} = 700\text{ mA}$$

Recommended Soldering Footprint

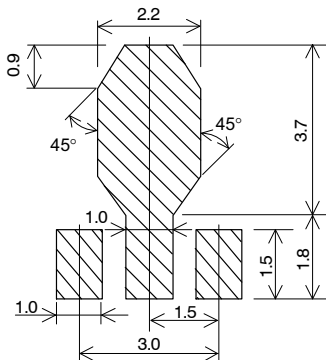

TYPICAL CHARACTERISTICS

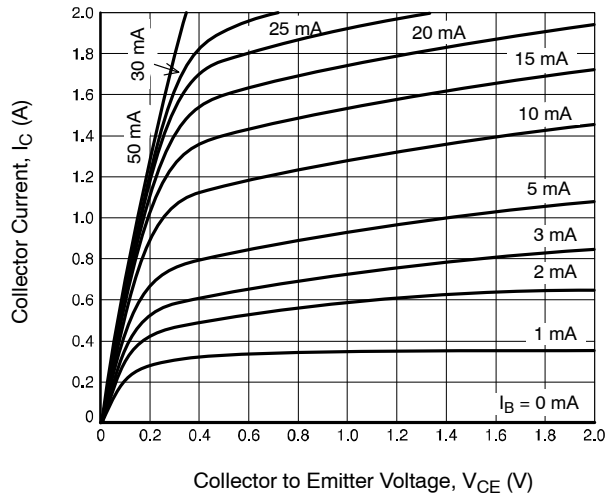

Figure 1. $I_C - V_{CE}$

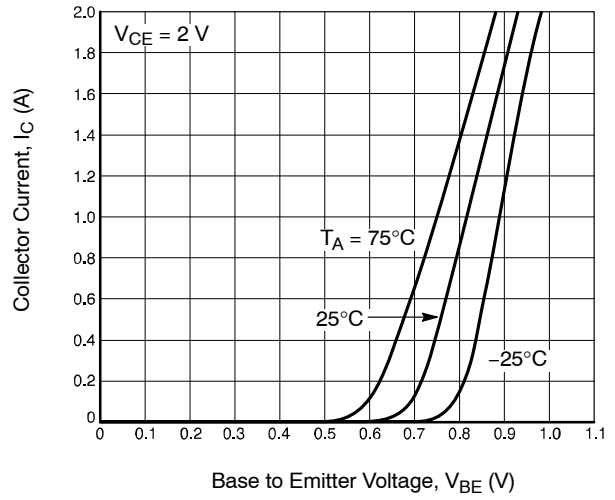

Figure 2. $I_C - V_{BE}$

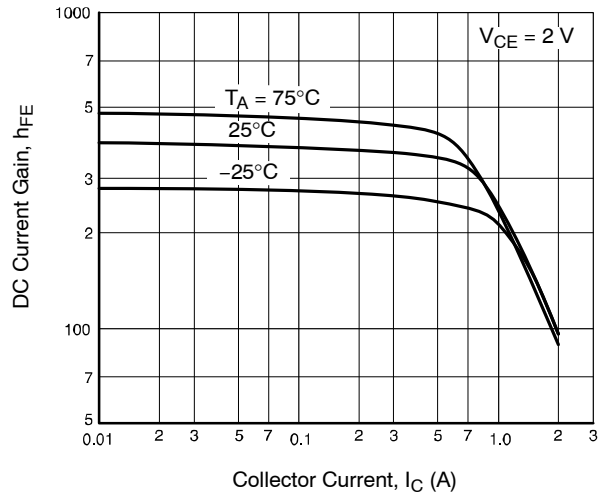

Figure 3. $h_{FE} - I_C$

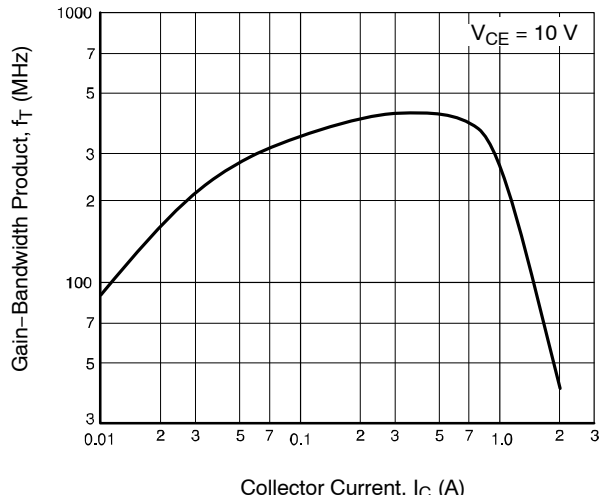

Figure 4. $f_T - I_C$

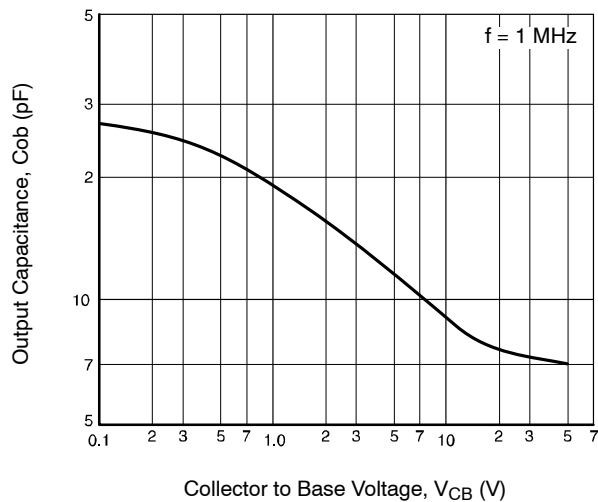

Figure 5. $C_{ob} - V_{CB}$

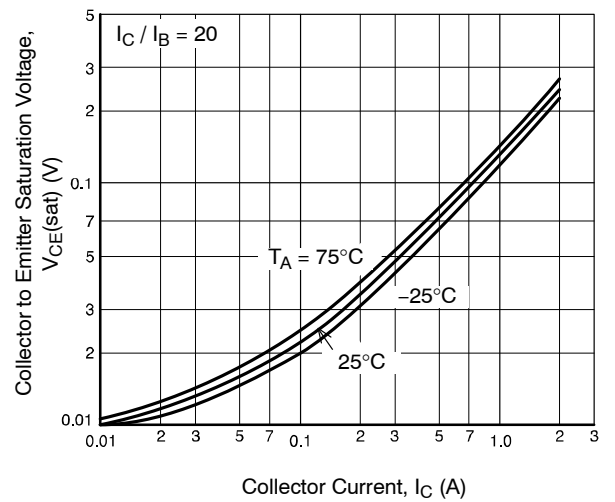

Figure 6. $V_{CE(sat)} - I_C$

TYPICAL CHARACTERISTICS (continued)

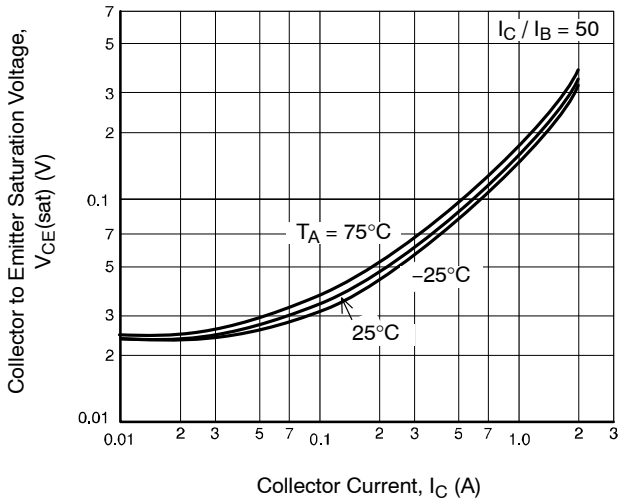

Figure 7. $V_{CE(sat)} - I_C$

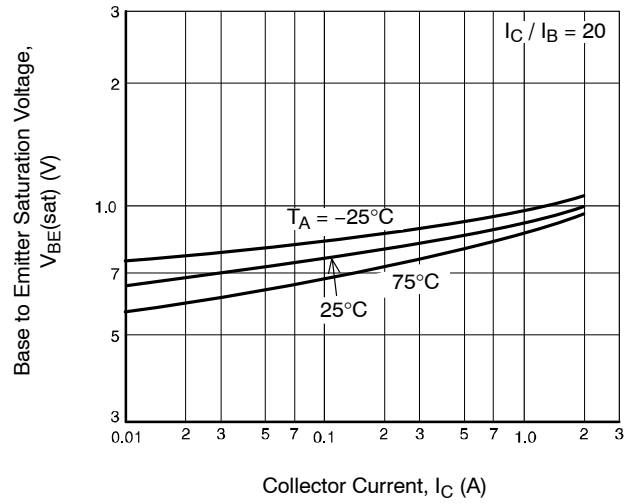

Figure 8. $V_{BE(sat)} - I_C$

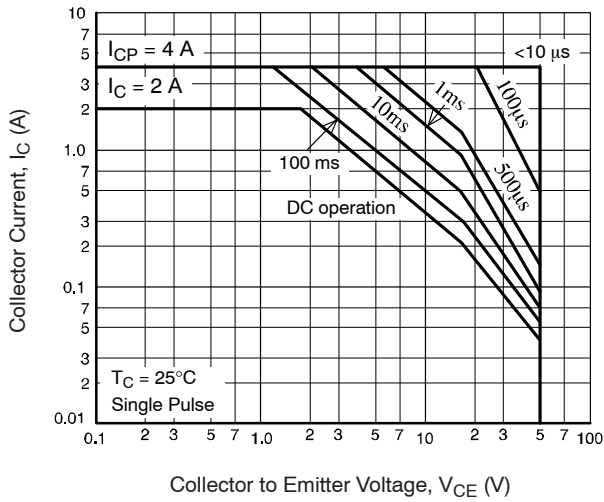

Figure 9. ASO

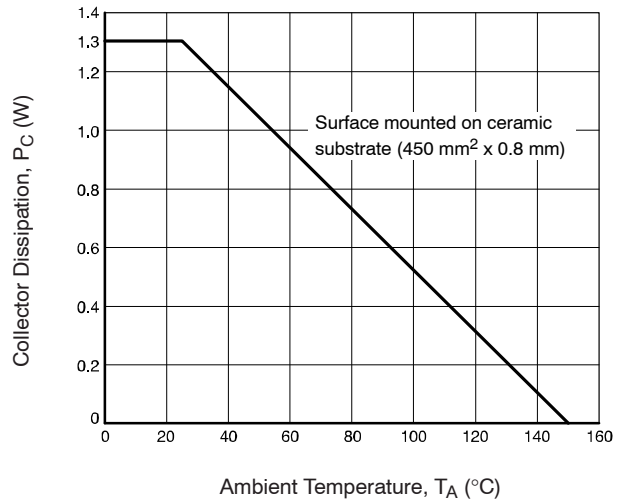

Figure 10. $P_C - T_A$

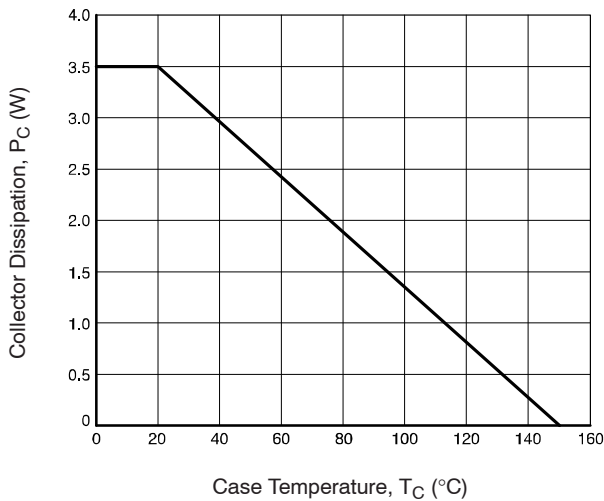

Figure 11. $P_C - T_C$

MECHANICAL CASE OUTLINE
PACKAGE DIMENSIONS

ON Semiconductor®



SOT-89 / PCP-1
CASE 419AU
ISSUE O

DATE 30 APR 2012

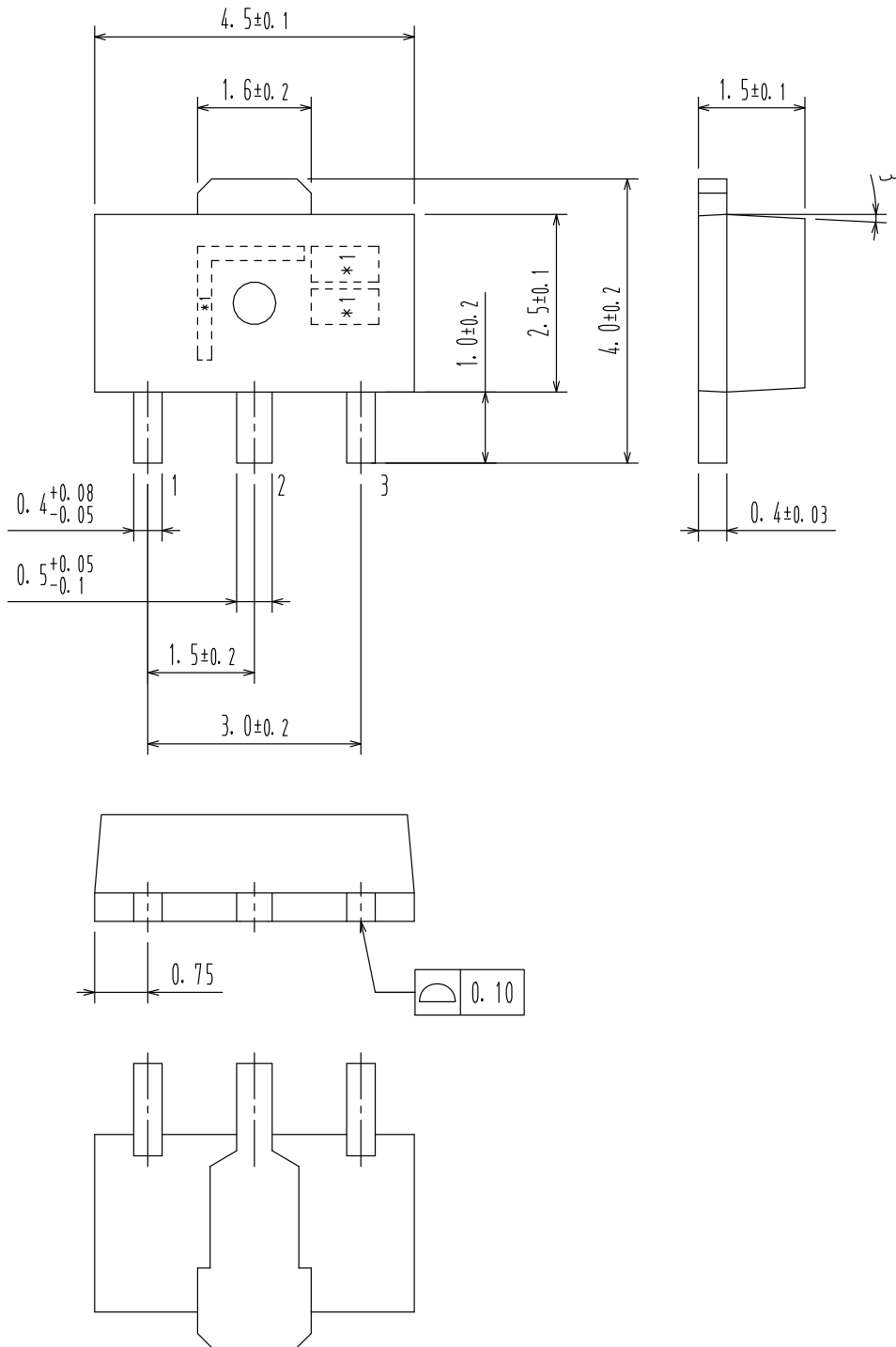

DOCUMENT NUMBER:	98AON79746E	Electronic versions are uncontrolled except when accessed directly from the Document Repository. Printed versions are uncontrolled except when stamped "CONTROLLED COPY" in red.
DESCRIPTION:	SOT-89 / PCP-1	PAGE 1 OF 1

ON Semiconductor and are trademarks of Semiconductor Components Industries, LLC dba ON Semiconductor or its subsidiaries in the United States and/or other countries. ON Semiconductor reserves the right to make changes without further notice to any products herein. ON Semiconductor makes no warranty, representation or guarantee regarding the suitability of its products for any particular purpose, nor does ON Semiconductor assume any liability arising out of the application or use of any product or circuit, and specifically disclaims any and all liability, including without limitation special, consequential or incidental damages. ON Semiconductor does not convey any license under its patent rights nor the rights of others.

onsemi, **Onsemi**, and other names, marks, and brands are registered and/or common law trademarks of Semiconductor Components Industries, LLC dba "**onsemi**" or its affiliates and/or subsidiaries in the United States and/or other countries. **onsemi** owns the rights to a number of patents, trademarks, copyrights, trade secrets, and other intellectual property. A listing of **onsemi**'s product/patent coverage may be accessed at www.onsemi.com/site/pdf/Patent-Marking.pdf. **onsemi** reserves the right to make changes at any time to any products or information herein, without notice. The information herein is provided "as-is" and **onsemi** makes no warranty, representation or guarantee regarding the accuracy of the information, product features, availability, functionality, or suitability of its products for any particular purpose, nor does **onsemi** assume any liability arising out of the application or use of any product or circuit, and specifically disclaims any and all liability, including without limitation special, consequential or incidental damages. Buyer is responsible for its products and applications using **onsemi** products, including compliance with all laws, regulations and safety requirements or standards, regardless of any support or applications information provided by **onsemi**. "Typical" parameters which may be provided in **onsemi** data sheets and/or specifications can and do vary in different applications and actual performance may vary over time. All operating parameters, including "Typicals" must be validated for each customer application by customer's technical experts. **onsemi** does not convey any license under any of its intellectual property rights nor the rights of others. **onsemi** products are not designed, intended, or authorized for use as a critical component in life support systems or any FDA Class 3 medical devices or medical devices with a same or similar classification in a foreign jurisdiction or any devices intended for implantation in the human body. Should Buyer purchase or use **onsemi** products for any such unintended or unauthorized application, Buyer shall indemnify and hold **onsemi** and its officers, employees, subsidiaries, affiliates, and distributors harmless against all claims, costs, damages, and expenses, and reasonable attorney fees arising out of, directly or indirectly, any claim of personal injury or death associated with such unintended or unauthorized use, even if such claim alleges that **onsemi** was negligent regarding the design or manufacture of the part. **onsemi** is an Equal Opportunity/Affirmative Action Employer. This literature is subject to all applicable copyright laws and is not for resale in any manner.

ADDITIONAL INFORMATION

TECHNICAL PUBLICATIONS:

Technical Library: www.onsemi.com/design/resources/technical-documentation
onsemi Website: www.onsemi.com

ONLINE SUPPORT: www.onsemi.com/support

For additional information, please contact your local Sales Representative at www.onsemi.com/support/sales