



Is Now Part of



ON Semiconductor®

To learn more about ON Semiconductor, please visit our website at
www.onsemi.com

Please note: As part of the Fairchild Semiconductor integration, some of the Fairchild orderable part numbers will need to change in order to meet ON Semiconductor's system requirements. Since the ON Semiconductor product management systems do not have the ability to manage part nomenclature that utilizes an underscore (_), the underscore (_) in the Fairchild part numbers will be changed to a dash (-). This document may contain device numbers with an underscore (_). Please check the ON Semiconductor website to verify the updated device numbers. The most current and up-to-date ordering information can be found at www.onsemi.com. Please email any questions regarding the system integration to Fairchild_questions@onsemi.com.

ON Semiconductor and the ON Semiconductor logo are trademarks of Semiconductor Components Industries, LLC dba ON Semiconductor or its subsidiaries in the United States and/or other countries. ON Semiconductor owns the rights to a number of patents, trademarks, copyrights, trade secrets, and other intellectual property. A listing of ON Semiconductor's product/patent coverage may be accessed at www.onsemi.com/site/pdf/Patent-Marking.pdf. ON Semiconductor reserves the right to make changes without further notice to any products herein. ON Semiconductor makes no warranty, representation or guarantee regarding the suitability of its products for any particular purpose, nor does ON Semiconductor assume any liability arising out of the application or use of any product or circuit, and specifically disclaims any and all liability, including without limitation special, consequential or incidental damages. Buyer is responsible for its products and applications using ON Semiconductor products, including compliance with all laws, regulations and safety requirements or standards, regardless of any support or applications information provided by ON Semiconductor. "Typical" parameters which may be provided in ON Semiconductor data sheets and/or specifications can and do vary in different applications and actual performance may vary over time. All operating parameters, including "Typicals" must be validated for each customer application by customer's technical experts. ON Semiconductor does not convey any license under its patent rights nor the rights of others. ON Semiconductor products are not designed, intended, or authorized for use as a critical component in life support systems or any FDA Class 3 medical devices or medical devices with a same or similar classification in a foreign jurisdiction or any devices intended for implantation in the human body. Should Buyer purchase or use ON Semiconductor products for any such unintended or unauthorized application, Buyer shall indemnify and hold ON Semiconductor and its officers, employees, subsidiaries, affiliates, and distributors harmless against all claims, costs, damages, and expenses, and reasonable attorney fees arising out of, directly or indirectly, any claim of personal injury or death associated with such unintended or unauthorized use, even if such claim alleges that ON Semiconductor was negligent regarding the design or manufacture of the part. ON Semiconductor is an Equal Opportunity/Affirmative Action Employer. This literature is subject to all applicable copyright laws and is not for resale in any manner.

FNB41560 / FNB41560B2

Motion SPM® 45 Series

Features

- UL Certified No. E209204 (UL1557)
- 600 V - 15 A 3-Phase IGBT Inverter with Integral Gate Drivers and Protection
- Low Thermal Resistance Using Ceramic Substrate
- Low-Loss, Short-Circuit Rated IGBTs
- Built-In Bootstrap Diodes and Dedicated Vs Pins Simplify PCB Layout
- Built-In NTC Thermistor for Temperature Monitoring
- Separate Open-Emitter Pins from Low-Side IGBTs for Three-Phase Current Sensing
- Single-Grounded Power Supply
- Isolation Rating: 2000 V_{rms} / min.

Applications

- Motion Control - Home Appliance / Industrial Motor

Related Resources

- [AN-9070 - Motion SPM® 45 Series Users Guide](#)
- [AN-9071 - Motion SPM® 45 Series Thermal Performance Information](#)
- [AN-9072 - Motion SPM® 45 Series Mounting Guidance](#)
- [RD-344 - Reference Design \(Three Shunt Solution\)](#)
- [RD-345 - Reference Design \(One Shunt Solution\)](#)

General Description

FNB41560 / FNB41560B2 is an advanced Motion SPM® 45 module providing a fully-featured, high-performance inverter output stage for AC Induction, BLDC, and PMSM motors. These modules integrate optimized gate drive of the built-in IGBTs to minimize EMI and losses, while also providing multiple on-module protection features including under-voltage lockouts, over-current shutdown, thermal monitoring, and fault reporting. The built-in, high-speed HVIC requires only a single supply voltage and translates the incoming logic-level gate inputs to the high-voltage, high-current drive signals required to properly drive the module's robust short-circuit-rated IGBTs. Separate negative IGBT terminals are available for each phase to support the widest variety of control algorithms.

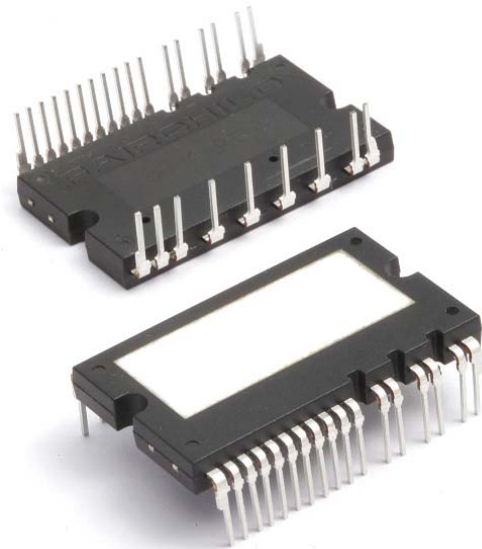

Figure 1. Package Overview

Package Marking and Ordering Information

Device	Device Marking	Package	Packing Type	Quantity
FNB41560	FNB41560	SPMAA-A26	Rail	12
FNB41560B2	FNB41560B2	SPMAA-C26	Rail	12

Integrated Power Functions

- 600 V - 15 A IGBT inverter for three-phase DC / AC power conversion (please refer to Figure 3)

Integrated Drive, Protection, and System Control Functions

- For inverter high-side IGBTs: gate drive circuit, high-voltage isolated high-speed level shifting control circuit Under-Voltage Lock-Out (UVLO) protection
- For inverter low-side IGBTs: gate drive circuit, Short-Circuit Protection (SCP) control supply circuit Under-Voltage Lock-Out (UVLO) protection
- Fault signaling: corresponding to UVLO (low-side supply) and SC faults
- Input interface: active-HIGH interface, works with 3.3 / 5 V logic, Schmitt trigger input

Pin Configuration



Figure 2. Top View

Pin Descriptions

Pin Number	Pin Name	Pin Description
1	V_{TH}	Thermistor Bias Voltage
2	R_{TH}	Series Resistor for the Use of Thermistor (Temperature Detection)
3	P	Positive DC-Link Input
4	U	Output for U-Phase
5	V	Output for V-Phase
6	W	Output for W-Phase
7	N_U	Negative DC-Link Input for U-Phase
8	N_V	Negative DC-Link Input for V-Phase
9	N_W	Negative DC-Link Input for W-Phase
10	C_{SC}	Capacitor (Low-Pass Filter) for Short-circuit Current Detection Input
11	V_{FO}	Fault Output
12	$IN_{(WL)}$	Signal Input for Low-Side W-Phase
13	$IN_{(VL)}$	Signal Input for Low-Side V-Phase
14	$IN_{(UL)}$	Signal Input for Low-Side U-Phase
15	COM	Common Supply Ground
16	$V_{CC(L)}$	Low-Side Common Bias Voltage for IC and IGBTs Driving
17	$V_{CC(H)}$	High-Side Common Bias Voltage for IC and IGBTs Driving
18	$IN_{(WH)}$	Signal Input for High-Side W-Phase
19	$IN_{(VH)}$	Signal Input for High-Side V-Phase
20	$IN_{(UH)}$	Signal Input for High-Side U-Phase
21	$V_{S(W)}$	High-Side Bias Voltage Ground for W-Phase IGBT Driving
22	$V_{B(W)}$	High-Side Bias Voltage for W-Phase IGBT Driving
23	$V_{S(V)}$	High-Side Bias Voltage Ground for V-Phase IGBT Driving
24	$V_{B(V)}$	High-Side Bias Voltage for V-Phase IGBT Driving
25	$V_{S(U)}$	High-Side Bias Voltage Ground for U-Phase IGBT Driving
26	$V_{B(U)}$	High-Side Bias Voltage for U-Phase IGBT Driving

Internal Equivalent Circuit and Input/Output Pins



Figure 3. Internal Block Diagram

1st Notes:

1. Inverter high-side is composed of three IGBTs, freewheeling diodes, and one control IC for each IGBT.
2. Inverter low-side is composed of three IGBTs, freewheeling diodes, and one control IC for each IGBT. It has gate drive and protection functions.
3. Inverter power side is composed of four inverter DC-link input terminals and three inverter output terminals.

Absolute Maximum Ratings (T_J = 25°C, unless otherwise specified.)

Inverter Part

Symbol	Parameter	Conditions	Rating	Unit
V _{PN}	Supply Voltage	Applied between P - N _U , N _V , N _W	450	V
V _{PN(Surge)}	Supply Voltage (Surge)	Applied between P - N _U , N _V , N _W	500	V
V _{CES}	Collector - Emitter Voltage		600	V
I _{O,25}	Output Phase Current	T _C = 25°C, T _J < 150°C (2nd Note 1)	15	A
I _{O,100}	Output Phase Current	T _C = 100°C, T _J < 150°C (2nd Note 1)	7.5	A
I _{pk}	Output Peak Phase Current	T _C = 25°C, T _J < 150°C, Under 1 ms Pulse Width	22	A
P _C	Collector Dissipation	T _C = 25°C per Chip	34	W
T _J	Operating Junction Temperature	(2nd Note 2)	-40 ~ 150	°C

2nd Notes:

- Sinusoidal PWM at V_{PN} = 300 V, V_{CC} = V_{BS} = 15 V, T_J < 150°C, F_{SW} = 20 kHz, MI = 0.9, PF = 0.8
- The maximum junction temperature rating of the power chips integrated within the Motion SPM® 45 product is 150°C.

Control Part

Symbol	Parameter	Conditions	Rating	Unit
V _{CC}	Control Supply Voltage	Applied between V _{CC(H)} , V _{CC(L)} - COM	20	V
V _{BS}	High - Side Control Bias Voltage	Applied between V _{B(U)} - V _{S(U)} , V _{B(V)} - V _{S(V)} , V _{B(W)} - V _{S(W)}	20	V
V _{IN}	Input Signal Voltage	Applied between IN _(UH) , IN _(VH) , IN _(WH) , IN _(UL) , IN _(VL) , IN _(WL) - COM	-0.3 ~ V _{CC} + 0.3	V
V _{FO}	Fault Output Supply Voltage	Applied between V _{FO} - COM	-0.3 ~ V _{CC} + 0.3	V
I _{FO}	Fault Output Current	Sink Current at V _{FO} pin	1	mA
V _{SC}	Current-Sensing Input Voltage	Applied between C _{SC} - COM	-0.3 ~ V _{CC} + 0.3	V

Bootstrap Diode Part

Symbol	Parameter	Conditions	Rating	Unit
V _{RRM}	Maximum Repetitive Reverse Voltage		600	V
I _F	Forward Current	T _C = 25°C, T _J < 150°C	0.50	A
I _{FP}	Forward Current (Peak)	T _C = 25°C, T _J < 150°C, Under 1 ms Pulse Width	1.50	A
T _J	Operating Junction Temperature		-40 ~ 150	°C

Total System

Symbol	Parameter	Conditions	Rating	Unit
V _{PN(PROT)}	Self-Protection Supply Voltage Limit (Short-Circuit Protection Capability)	V _{CC} = V _{BS} = 13.5 ~ 16.5 V T _J = 150°C, Non-Repetitive, < 2 μs	400	V
T _{STG}	Storage Temperature		-40 ~ 125	°C
V _{ISO}	Isolation Voltage	60 Hz, Sinusoidal, AC 1 Minute, Connect Pins to Heat Sink Plate	2000	V _{rms}

Thermal Resistance

Symbol	Parameter	Conditions	Min.	Typ.	Max.	Unit
R _{th(j-c)Q}	Junction to Case Thermal Resistance	Inverter IGBT Part (per 1 / 6 module)	-	-	3.6	°C / W
R _{th(j-c)F}		Inverter FWDi Part (per 1 / 6 module)	-	-	4.8	°C / W

2nd Notes:

- For the measurement point of case temperature (T_C), please refer to Figure 2.

Electrical Characteristics ($T_J = 25^\circ\text{C}$, unless otherwise specified.)

Inverter Part

Symbol	Parameter	Conditions	Min.	Typ.	Max.	Unit	
$V_{CE(SAT)}$	Collector - Emitter Saturation Voltage	$V_{CC} = V_{BS} = 15\text{ V}$ $V_{IN} = 5\text{ V}$ $I_C = 7.5\text{ A}, T_J = 25^\circ\text{C}$	-	1.6	2.1	V	
V_F	FWDI Forward Voltage	$V_{IN} = 0\text{ V}$ $I_F = 7.5\text{ A}, T_J = 25^\circ\text{C}$	-	1.7	2.2	V	
HS	Switching Times	$V_{PN} = 300\text{ V}, V_{CC} = V_{BS} = 15\text{ V}, I_C = 7.5\text{ A}$ $T_J = 25^\circ\text{C}$ $V_{IN} = 0\text{ V} \leftrightarrow 5\text{ V}$, Inductive Load (2nd Note 4)	t_{ON}	0.40	0.70	1.20	μs
			$t_{C(ON)}$	-	0.15	0.40	μs
			t_{OFF}	-	0.65	1.15	μs
			$t_{C(OFF)}$	-	0.15	0.40	μs
			t_{rr}	-	0.15	-	μs
LS	Switching Times	$V_{PN} = 300\text{ V}, V_{CC} = V_{BS} = 15\text{ V}, I_C = 7.5\text{ A}$ $T_J = 25^\circ\text{C}$ $V_{IN} = 0\text{ V} \leftrightarrow 5\text{ V}$, Inductive Load (2nd Note 4)	t_{ON}	0.40	0.70	1.20	μs
			$t_{C(ON)}$	-	0.15	0.40	μs
			t_{OFF}	-	0.65	1.15	μs
			$t_{C(OFF)}$	-	0.15	0.40	μs
			t_{rr}	-	0.10	-	μs
I_{CES}	Collector - Emitter Leakage Current	$V_{CE} = V_{CES}$	-	-	1	mA	

2nd Notes:

4. t_{ON} and t_{OFF} include the propagation delay of the internal drive IC. $t_{C(ON)}$ and $t_{C(OFF)}$ are the switching time of IGBT itself under the given gate driving condition internally. For the detailed information, please see Figure 4.

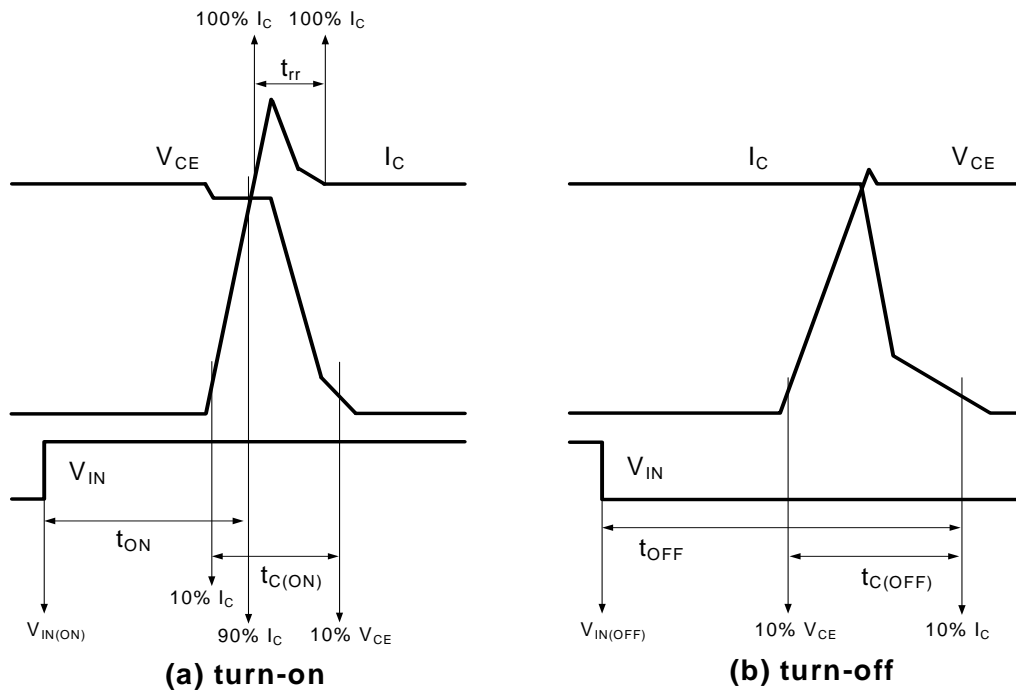

Figure 4. Switching Time Definition

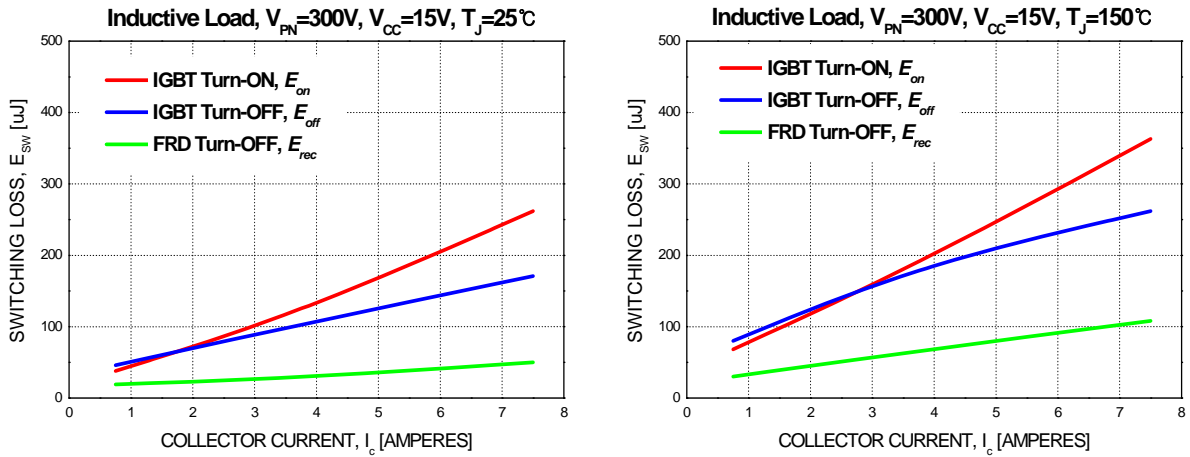

Figure 5. Switching Loss Characteristics (Typical)

Control Part

Symbol	Parameter	Conditions	Min.	Typ.	Max.	Unit	
I _{QCCH}	Quiescent V _{CC} Supply Current	V _{CC(H)} = 15 V, I _{N(UH,VH,WH)} = 0 V	V _{CC(H)} - COM	-	-	0.10	mA
I _{QCCL}		V _{CC(L)} = 15 V, I _{N(UL,VL,WL)} = 0 V	V _{CC(L)} - COM	-	-	2.65	mA
I _{PCCH}	Operating V _{CC} Supply Current	V _{CC(L)} = 15 V, f _{PWM} = 20 kHz, duty = 50%, Applied to One PWM Signal Input for High-Side	V _{CC(H)} - COM	-	-	0.15	mA
I _{PCCL}		V _{CC(L)} = 15 V, f _{PWM} = 20 kHz, duty = 50%, Applied to One PWM Signal Input for Low-Side	V _{CC(L)} - COM	-	-	3.65	mA
I _{QBS}	Quiescent V _{BS} Supply Current	V _{BS} = 15 V, I _{N(UH, VH, WH)} = 0 V	V _{B(U)} - V _{S(U)} , V _{B(V)} - V _{S(V)} , V _{B(W)} - V _{S(W)}	-	-	0.30	mA
I _{PBS}	Operating V _{BS} Supply Current	V _{CC} = V _{BS} = 15 V, f _{PWM} = 20 kHz, Duty = 50%, Applied to One PWM Signal Input for High-Side	V _{B(U)} - V _{S(U)} , V _{B(V)} - V _{S(V)} , V _{B(W)} - V _{S(W)}	-	-	2.00	mA
V _{FOH}	Fault Output Voltage	V _{SC} = 0 V, V _{FO} Circuit: 10 kΩ to 5 V Pull-up	4.5	-	-	V	
V _{FOL}		V _{SC} = 1 V, V _{FO} Circuit: 10 kΩ to 5 V Pull-up	-	-	0.5	V	
V _{SC(ref)}	Short-Circuit Current Trip Level	V _{CC} = 15 V (2nd Note 5)	0.45	0.50	0.55	V	
UV _{CCD}	Supply Circuit Under-Voltage Protection	Detection level	10.5	-	13.0	V	
UV _{CCR}		Reset level	11.0	-	13.5	V	
UV _{BSD}		Detection level	10.0	-	12.5	V	
UV _{BSR}		Reset level	10.5	-	13.0	V	
t _{FOD}	Fault-Out Pulse Width		30	-	-	μs	
V _{IN(ON)}	ON Threshold Voltage	Applied between I _{N(UH)} , I _{N(VH)} , I _{N(WH)} , I _{N(UL)} , I _{N(VL)} , I _{N(WL)} - COM	-	-	2.6	V	
V _{IN(OFF)}	OFF Threshold Voltage		0.8	-	-	V	
R _{TH}	Resistance of Thermister	@ T _{TH} = 25°C, (2nd Note 6)	-	47	-	kΩ	
		@ T _{TH} = 100°C	-	2.9	-	kΩ	

2nd Notes:

- Short-circuit protection is functioning only at the low-sides.
- T_{TH} is the temperature of thermister itself. To know case temperature (T_C), please make the experiment considering your application.



Figure. 6. R-T Curve of The Built-In Thermistor

Bootstrap Diode Part

Symbol	Parameter	Conditions	Min.	Typ.	Max.	Unit
V_F	Forward Voltage	$I_F = 0.1 \text{ A}, T_C = 25^\circ\text{C}$	-	2.5	-	V
t_{rr}	Reverse-Recovery Time	$I_F = 0.1 \text{ A}, T_C = 25^\circ\text{C}$	-	80	-	ns

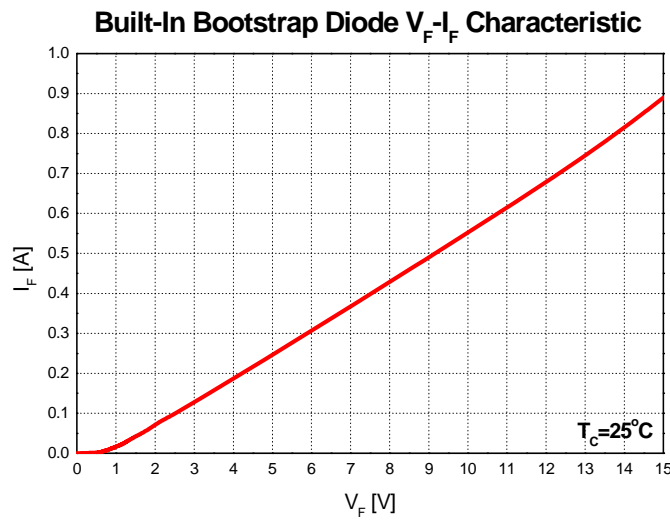

Figure 7. Built-In Bootstrap Diode Characteristic

2nd Notes:

7. Built-in bootstrap diode includes around 15 Ω resistance characteristic.

Recommended Operating Conditions

Symbol	Parameter	Conditions	Min.	Typ.	Max.	Unit
V_{PN}	Supply Voltage	Applied between P - N_U, N_V, N_W	-	300	400	V
V_{CC}	Control Supply Voltage	Applied between $V_{CC(H)}, V_{CC(L)}$ - COM	13.5	15	16.5	V
V_{BS}	High-Side Bias Voltage	Applied between $V_{B(U)} - V_{S(U)}, V_{B(V)} - V_{S(V)}, V_{B(W)} - V_{S(W)}$	13.0	15	18.5	V
$dV_{CC}/dt, dV_{BS}/dt$	Control Supply Variation		- 1	-	1	V / μ s
t_{dead}	Blanking Time for Preventing Arm-Short	For each input signal	1.5	-	-	μ s
f_{PWM}	PWM Input Signal	$-40^\circ\text{C} < T_J < 150^\circ\text{C}$	-	-	20	kHz
V_{SEN}	Voltage for Current Sensing	Applied between N_U, N_V, N_W - COM (Including Surge-Voltage)	- 4		4	V
$P_{WIN(ON)}$	Minimum Input Pulse Width	(2nd Note 8)	0.5	-	-	μ s
$P_{WIN(OFF)}$			0.5	-	-	

2nd Notes:

8. This product might not make response if input pulse width is less than the recommended value.

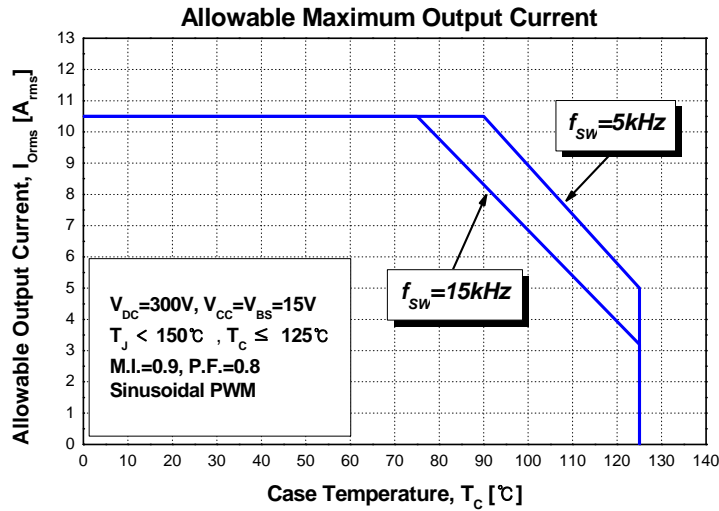

Figure 8. Allowable Maximum Output Current

2nd Notes:

9. This allowable output current value is the reference data for the safe operation of this product. This may be different from the actual application and operating condition.

Mechanical Characteristics and Ratings

Parameter	Conditions	Min.	Typ.	Max.	Unit	
Device Flatness	See Figure 9	0	-	+ 120	μm	
Mounting Torque	Mounting Screw: M3	Recommended 0.7 N • m	0.6	0.7	0.8	N • m
	See Figure 10	Recommended 7.1 kg • cm	6.2	7.1	8.1	kg • cm
Weight		-	11	-	g	



Figure 9. Flatness Measurement Position

Pre - Screwing : 1→2

Final Screwing : 2→1



Figure 10. Mounting Screws Torque Order

2nd Notes:

- 10. Do not make over torque when mounting screws. Much mounting torque may cause ceramic cracks, as well as bolts and Al heat-sink destruction.
- 11. Avoid one side tightening stress. Figure 10 shows the recommended torque order for mounting screws. Uneven mounting can cause the ceramic substrate of the SPM® 45 package to be damaged. The pre-screwing torque is set to 20 ~ 30% of maximum torque rating.

Time Charts of Protective Function



- a1 : Control supply voltage rises: after the voltage rises UV_{CCR} , the circuits start to operate when next input is applied.
- a2 : Normal operation: IGBT ON and carrying current.
- a3 : Under-voltage detection (UV_{CCD}).
- a4 : IGBT OFF in spite of control input condition.
- a5 : Fault output operation starts.
- a6 : Under-voltage reset (UV_{CCR}).
- a7 : Normal operation: IGBT ON and carrying current.

Figure 11. Under-Voltage Protection (Low-Side)



- b1 : Control supply voltage rises: after the voltage reaches UV_{BSR} , the circuits start to operate when next input is applied.
- b2 : Normal operation: IGBT ON and carrying current.
- b3 : Under-voltage detection (UV_{BSD}).
- b4 : IGBT OFF in spite of control input condition, but there is no fault output signal.
- b5 : Under-voltage reset (UV_{BSR}).
- b6 : Normal operation: IGBT ON and carrying current.

Figure 12. Under-Voltage Protection (High-Side)



(with the external shunt resistance and CR connection)

- c1 : Normal operation: IGBT ON and carrying current.
- c2 : Short-circuit current detection (SC trigger).
- c3 : Hard IGBT gate interrupt.
- c4 : IGBT turns OFF.
- c5 : Input "LOW": IGBT OFF state.
- c6 : Input "HIGH": IGBT ON state, but during the active period of fault output, the IGBT doesn't turn ON.
- c7 : IGBT OFF state.

Figure 13. Short-Circuit Protection (Low-Side Operation Only)

Input/Output Interface Circuit



Figure 14. Recommended MCU I/O Interface Circuit

2nd Notes:

12. RC coupling at each input (parts shown dotted) might change depending on the PWM control scheme in the application and the wiring impedance of the application's printed circuit board. The input signal section of the Motion SPM® 45 product integrates a 5 kΩ (typ.) pull-down resistor. Therefore, when using an external filtering resistor, pay attention to the signal voltage drop at input terminal.

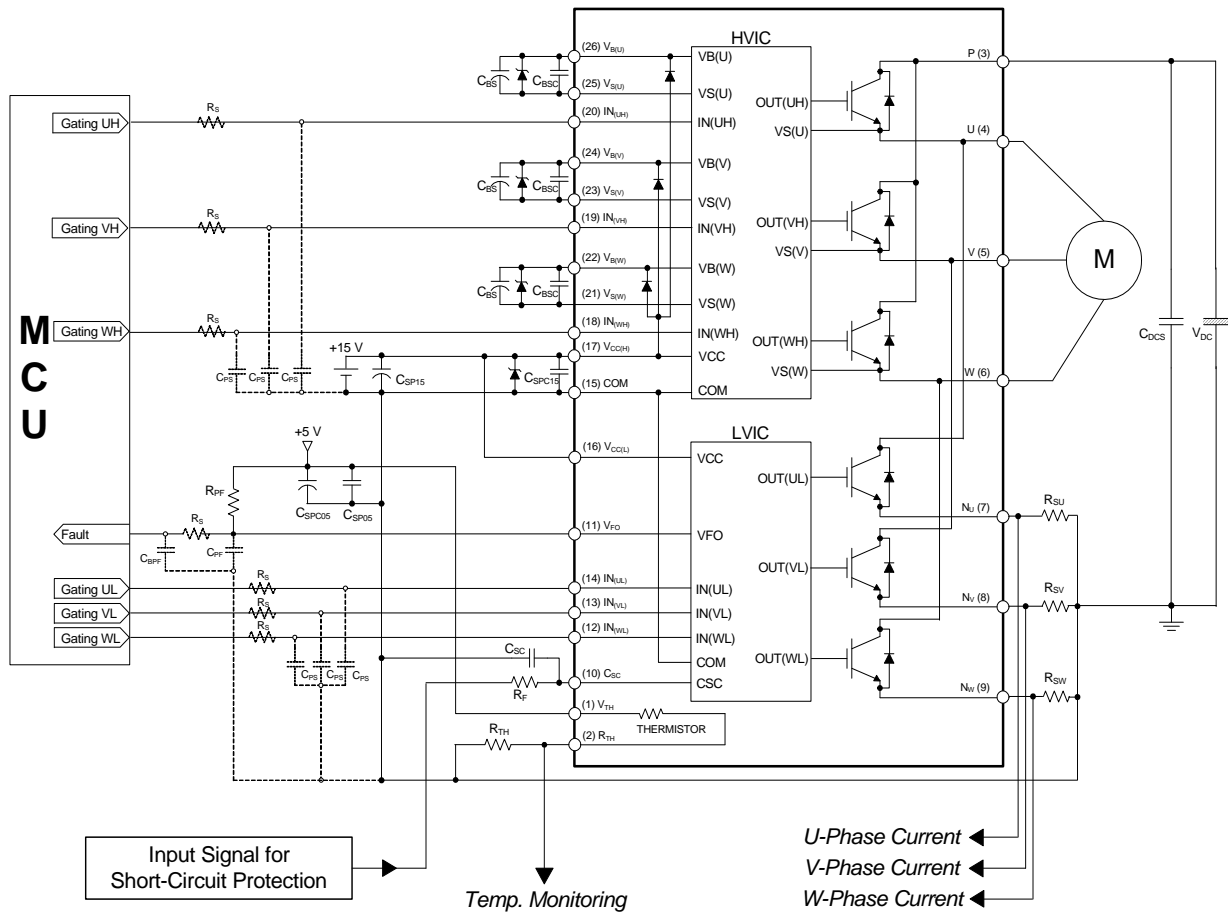
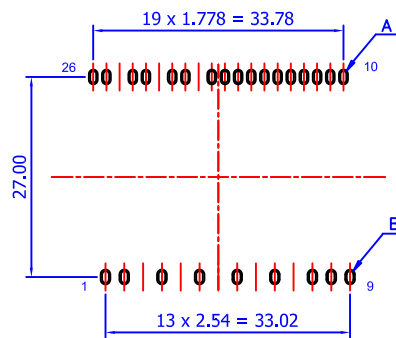

Figure 15. Typical Application Circuit

3rd Notes:

- 1) To avoid malfunction, the wiring of each input should be as short as possible (less than 2 - 3 cm).
- 2) By virtue of integrating an application-specific type of HVIC inside the Motion SPM® 45 product, direct coupling to MCU terminals without any optocoupler or transformer isolation is possible.
- 3) V_{FO} output is open-drain type. This signal line should be pulled up to the positive side of the MCU or control power supply with a resistor that makes I_{FO} up to 1 mA (please refer to Figure 14).
- 4) C_{SP15} of around seven times larger than bootstrap capacitor C_{BS} is recommended.
- 5) Input signal is active-HIGH type. There is a 5 kΩ resistor inside the IC to pull down each input signal line to GND. RC coupling circuits is recommended for the prevention of input signal oscillation. R_{SPS} time constant should be selected in the range 50 ~ 150 ns (recommended R_S = 100 Ω, C_{PS} = 1 nF).
- 6) To prevent errors of the protection function, the wiring around R_F and C_{SC} should be as short as possible.
- 7) In the short-circuit protection circuit, please select the R_FC_{SC} time constant in the range 1.5 ~ 2 μs.
- 8) The connection between control GND line and power GND line which includes the N_U, N_V, N_W must be connected to only one point. Please do not connect the control GND to the power GND by the broad pattern. Also, the wiring distance between control GND and power GND should be as short as possible.
- 9) Each capacitor should be mounted as close to the pins of the Motion SPM 45 product as possible.
- 10) To prevent surge destruction, the wiring between the smoothing capacitor and the P & GND pins should be as short as possible. The use of a high-frequency non-inductive capacitor of around 0.1 ~ 0.22 μF between the P and GND pins is recommended.
- 11) Relays are used in almost every systems of electrical equipment in home appliances. In these cases, there should be sufficient distance between the MCU and the relays.
- 12) The zener diode or transient voltage suppressor should be adopted for the protection of ICs from the surge destruction between each pair of control supply terminals (recommended zener diode is 22 V / 1 W, which has the lower zener impedance characteristic than about 15 Ω).
- 13) Please choose the electrolytic capacitor with good temperature characteristic in C_{BS}. Also, choose 0.1 ~ 0.2 μF R-category ceramic capacitors with good temperature and frequency characteristics in C_{BSC}.
- 14) For the detailed information, please refer to the AN-9070, AN-9071, AN-9072, RD-344, and RD-345.



- NOTES: UNLESS OTHERWISE SPECIFIED
 A) THIS PACKAGE DOES NOT COMPLY TO ANY CURRENT PACKAGING STANDARD
 B) ALL DIMENSIONS ARE IN MILLIMETERS
 C) DIMENSIONS ARE EXCLUSIVE OF BURRS, MOLD FLASH, AND TIE BAR EXTRUSIONS
 D) () IS REFERENCE
 E) [] IS ASS'Y QUALITY
 F) DRAWING FILENAME: MOD26ACREV3

LAND PATTERN RECOMMENDATIONS



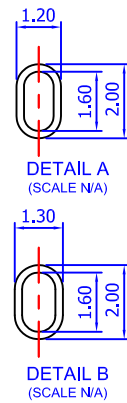
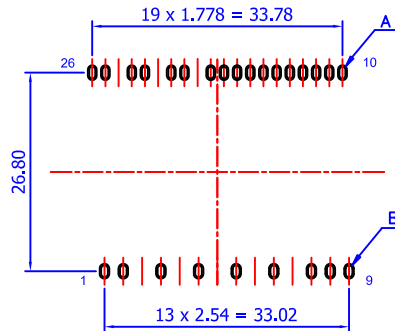
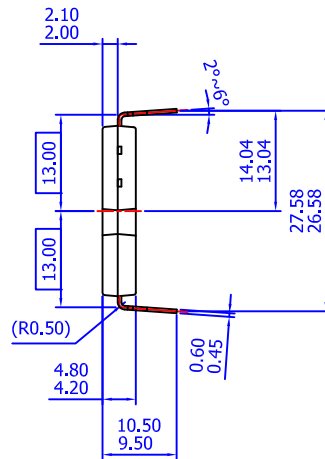

- NOTES: UNLESS OTHERWISE SPECIFIED
 A) THIS PACKAGE DOES NOT COMPLY TO ANY CURRENT PACKAGING STANDARD
 B) ALL DIMENSIONS ARE IN MILLIMETERS
 C) DIMENSIONS ARE EXCLUSIVE OF BURRS, MOLD FLASH, AND TIE BAR EXTRUSIONS
 D) () IS REFERENCE
 E) [] IS ASS'Y QUALITY
 F) DRAWING FILENAME: MOD26AAREV3

LAND PATTERN RECOMMENDATIONS



ON Semiconductor and  are trademarks of Semiconductor Components Industries, LLC dba ON Semiconductor or its subsidiaries in the United States and/or other countries. ON Semiconductor owns the rights to a number of patents, trademarks, copyrights, trade secrets, and other intellectual property. A listing of ON Semiconductor's product/patent coverage may be accessed at www.onsemi.com/site/pdf/Patent-Marking.pdf. ON Semiconductor reserves the right to make changes without further notice to any products herein. ON Semiconductor makes no warranty, representation or guarantee regarding the suitability of its products for any particular purpose, nor does ON Semiconductor assume any liability arising out of the application or use of any product or circuit, and specifically disclaims any and all liability, including without limitation special, consequential or incidental damages. Buyer is responsible for its products and applications using ON Semiconductor products, including compliance with all laws, regulations and safety requirements or standards, regardless of any support or applications information provided by ON Semiconductor. "Typical" parameters which may be provided in ON Semiconductor data sheets and/or specifications can and do vary in different applications and actual performance may vary over time. All operating parameters, including "Typicals" must be validated for each customer application by customer's technical experts. ON Semiconductor does not convey any license under its patent rights nor the rights of others. ON Semiconductor products are not designed, intended, or authorized for use as a critical component in life support systems or any FDA Class 3 medical devices or medical devices with a same or similar classification in a foreign jurisdiction or any devices intended for implantation in the human body. Should Buyer purchase or use ON Semiconductor products for any such unintended or unauthorized application, Buyer shall indemnify and hold ON Semiconductor and its officers, employees, subsidiaries, affiliates, and distributors harmless against all claims, costs, damages, and expenses, and reasonable attorney fees arising out of, directly or indirectly, any claim of personal injury or death associated with such unintended or unauthorized use, even if such claim alleges that ON Semiconductor was negligent regarding the design or manufacture of the part. ON Semiconductor is an Equal Opportunity/Affirmative Action Employer. This literature is subject to all applicable copyright laws and is not for resale in any manner.

PUBLICATION ORDERING INFORMATION

LITERATURE FULFILLMENT:

Literature Distribution Center for ON Semiconductor
19521 E. 32nd Pkwy, Aurora, Colorado 80011 USA
Phone: 303-675-2175 or 800-344-3860 Toll Free USA/Canada
Fax: 303-675-2176 or 800-344-3867 Toll Free USA/Canada
Email: orderlit@onsemi.com

N. American Technical Support: 800-282-9855 Toll Free
USA/Canada
Europe, Middle East and Africa Technical Support:
Phone: 421 33 790 2910
Japan Customer Focus Center
Phone: 81-3-5817-1050

ON Semiconductor Website: www.onsemi.com
Order Literature: <http://www.onsemi.com/orderlit>
For additional information, please contact your local
Sales Representative