

# IntelliMAX™ 3 A-Capable, Slew-Rate-Controlled Load Switch with True Reverse Current Blocking

## FPF1048

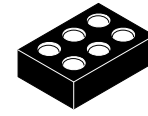

WLCSP6  
 CASE 567RM

### Description

The FPF1048 advanced load management switch targets applications requiring a highly integrated solution. It disconnects loads powered from the DC power rail (<6 V) with stringent off-state current targets and high load capacitances (up to 100  $\mu$ F). The FPF1048 consists of slew-rate controlled lowimpedance MOSFET switch (23 m $\Omega$  typical) and integrated analog features. The slew-rate controlled turn-on characteristic prevents inrush current and the resulting excessive voltage droop on power rails.

The FPF1048 has a True Reverse Current Blocking (TRCB) function that obstructs unwanted reverse current from  $V_{OUT}$  to  $V_{IN}$  during both ON and OFF states. The exceptionally low off-state current drain (<1  $\mu$ A maximum) facilitates compliance with standby power requirements. The input voltage range operates from 1.5 V to 5.5  $V_{DC}$  to support a wide range of applications in consumer, optical, medical, storage, portable, and industrial-device power management. Switch control is managed by a logic input (active HIGH) capable of interfacing directly with low-voltage control signal / General-Purpose Input / Output (GPIO) without an external pull-down resistor.

The device is packaged in advanced, fully “green” compliant, 1.0 mm x 1.5 mm, Wafer-Level Chip-Scale Package (WLCSP) with backside lamination.

### Features

- Input Voltage Operating Range: 1.5 V to 5.5 V
- Typical  $R_{DS(ON)}$ :
  - ◆ 21 m $\Omega$  at  $V_{IN} = 5.5$  V
  - ◆ 23 m $\Omega$  at  $V_{IN} = 4.5$  V
  - ◆ 41 m $\Omega$  at  $V_{IN} = 1.8$  V
  - ◆ 90 m $\Omega$  at  $V_{IN} = 1.5$  V
- Slew Rate/Inrush Control with  $t_R$ : 2.7 ms (Typ.)
- 3 A Maximum Continuous Current Capability
- Low Off Switch Current: <1  $\mu$ A
- True Reverse Current Blocking (TRCB)
- Logic CMOS IO Meets JESD76 Standard for GPIO Interface and Related Power Supply Requirements
- ESD Protected:
  - ◆ Human Body Model: >8 kV
  - ◆ Charged Device Model: >1.5 kV
  - ◆ IEC 61000-4-2 Air Discharge: >15 kV
  - ◆ IEC 61000-4-2 Contact Discharge: >8 kV
- This is a Pb-Free Device

### MARKING DIAGRAM

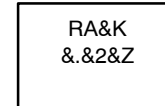

- RA = Device Code
- K = 2-Digits Lot Run Traceability Code
- &. = Pin One Dot
- &2 = 2-Digit Date Code
- &Z = Assembly Plant Code

### ORDERING INFORMATION

See detailed ordering and shipping information on page 11 of this data sheet.

### Applications

- Smart Phones, Tablet PCs
- Storage, DSLR, and Portable Devices

# FPF1048

## Application Diagram

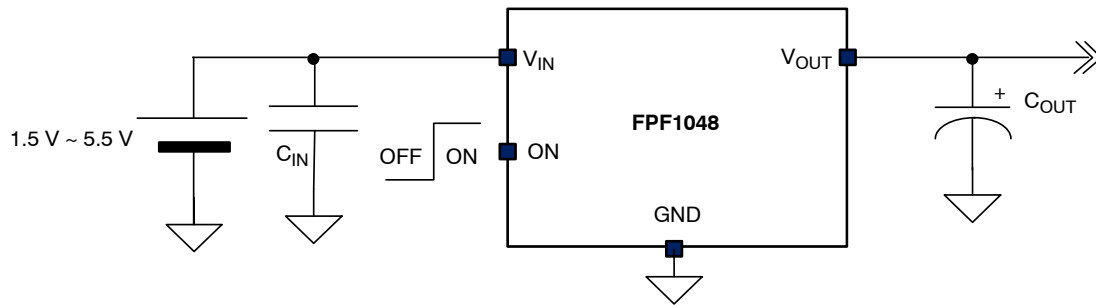

Figure 1. General Application

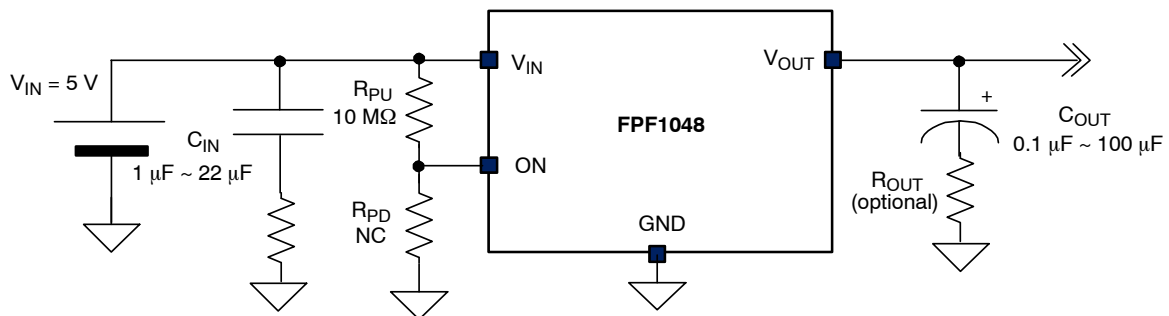

Figure 2. Specific Application with 10 MΩ Pull-Up Resistor at ON Pin

### NOTES:

1. Turn-on operation with a 10 MΩ pull-up resistor at ON pin is acceptable.
2.  $V_{IN}$  should be high enough to generate  $V_{ON}$  greater than  $V_{IH}$  at the ON pin.
3. NC means no connection.
4.  $R_{IN}$  and  $R_{OUT}$  can be added to reduce transient peak voltage. 1 Ω ~ 10 Ω is recommended.

# FPF1048

## Functional Block Diagram

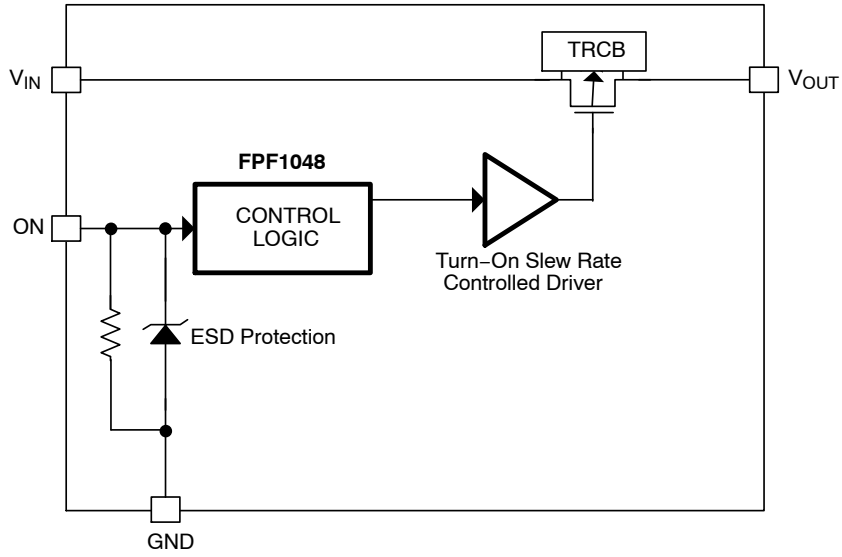

Figure 3. Functional Block Diagram

## Pin Configurations

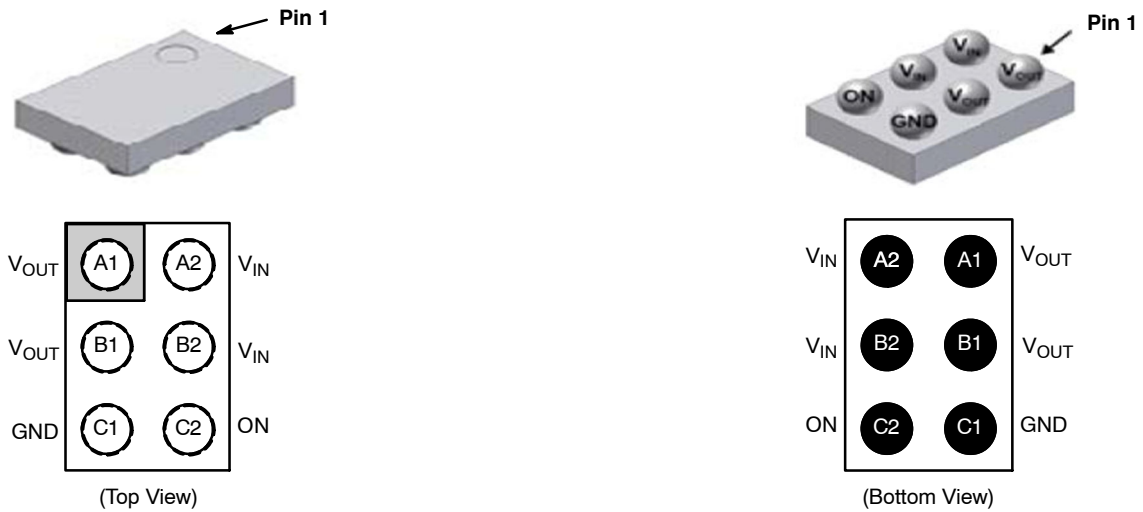

Figure 4. Pin Assignments

## PIN DESCRIPTIONS

Pin #	Name	Description
A1, B1	$V_{OUT}$	Switch Output
A2, B2	$V_{IN}$	Supply Input: Input to the Power Switch
C1	GND	Ground
C2	ON	ON/OFF Control, Active High, GPIO Compatible

**ABSOLUTE MAXIMUM RATINGS**

Symbol	Parameter		Min	Max	Unit	
$V_{IN}$	$V_{IN}$ , $V_{OUT}$ , $V_{ON}$ to GND		-0.3	6.0	V	
$I_{SW}$	Maximum Continuous Switch Current		-	3.0	A	
$P_D$	Power Dissipation at $T_A = 25^\circ\text{C}$		-	1.2	W	
$T_{STG}$	Storage Junction Temperature		-65	+150	$^\circ\text{C}$	
$T_A$	Operating Temperature Range		-40	+85	$^\circ\text{C}$	
$\theta_{JA}$	Thermal Resistance, Junction to Ambient		-	85 (Note 5)	$^\circ\text{C/W}$	
			-	110 (Note 6)		
ESD	Electrostatic Discharge Capability	Human Body Model, JESD22-A114	8.0	-	kV	
		Charged Device Model, JESD22-C101	1.5	-		
		IEC61000-4-2 System Level	Air Discharge ( $V_{IN}$ , $V_{ON}$ , $V_{OUT}$ to GND)	15.0		-
			Contact Discharge ( $V_{IN}$ , $V_{ON}$ , $V_{OUT}$ to GND)	8.0		-

Stresses exceeding those listed in the Maximum Ratings table may damage the device. If any of these limits are exceeded, device functionality should not be assumed, damage may occur and reliability may be affected.

5. Measured using 2S2P JEDEC std. PCB.

6. Measured using 2S2P JEDEC PCB cold plate method.

**RECOMMENDED OPERATING RANGE**

Symbol	Parameter	Min	Typ	Max	Unit
$V_{IN}$	Input Voltage	1.5	-	5.5	V
$T_A$	Ambient Operating Temperature	-40	-	+85	$^\circ\text{C}$
$I_{SW}$	Continuous Switch Current	-	2.5	3	A

Functional operation above the stresses listed in the Recommended Operating Ranges is not implied. Extended exposure to stresses beyond the Recommended Operating Ranges limits may affect device reliability.

# FPF1048

## ELECTRICAL CHARACTERISTICS

(Unless otherwise noted,  $V_{IN} = 1.5\text{ V to }5.5\text{ V}$ ,  $T_A = -40\text{ to }+85^\circ\text{C}$ , typical values are at  $V_{IN} = 4.5\text{ V}$  and  $T_A = 25^\circ\text{C}$ .)

Symbol	Parameter	Test Condition	Min	Typ	Max	Unit
<b>BASIC OPERATION</b>						
$V_{IN}$	Input Voltage		1.5	–	5.5	V
$I_{Q(OFF)}$	Off Supply Current	$V_{ON} = \text{GND}$ , $V_{OUT} = \text{Open}$	–	–	1	$\mu\text{A}$
$I_{SD}$	Shutdown Current	$V_{ON} = \text{GND}$ , $V_{OUT} = \text{GND}$ , $T_A = -40\text{ to }+85^\circ\text{C}$	–	0.2	4.0	$\mu\text{A}$
$I_Q$	Quiescent Current	$I_{OUT} = 0\text{ mA}$	–	–	11	$\mu\text{A}$
$R_{ON}$	On-Resistance	$V_{IN} = 5.5\text{ V}$ , $I_{OUT} = 3\text{ A}$ (Note 7)	–	22.0	–	$\text{m}\Omega$
		$V_{IN} = 5.5\text{ V}$ , $I_{OUT} = 2\text{ A}$ (Note 7)	–	21.5	–	
		$V_{IN} = 5.5\text{ V}$ , $I_{OUT} = 1\text{ A}$ , $T_A = 25^\circ\text{C}$	–	21.0	28.0	
		$V_{IN} = 4.5\text{ V}$ , $I_{OUT} = 3\text{ A}$ (Note 7)	–	24.0	–	
		$V_{IN} = 4.5\text{ V}$ , $I_{OUT} = 2\text{ A}$ (Note 7)	–	23.5	–	
		$V_{IN} = 4.5\text{ V}$ , $I_{OUT} = 1\text{ A}$ , $T_A = 25^\circ\text{C}$	–	23.0	30.0	
		$V_{IN} = 3.3\text{ V}$ , $I_{OUT} = 500\text{ mA}$ , $T_A = 25^\circ\text{C}$	–	26.0	–	
		$V_{IN} = 2.5\text{ V}$ , $I_{OUT} = 500\text{ mA}$ , $T_A = 25^\circ\text{C}$	–	30.0	–	
		$V_{IN} = 1.8\text{ V}$ , $I_{OUT} = 250\text{ mA}$ , $T_A = 25^\circ\text{C}$	–	41.0	–	
$V_{IN} = 1.5\text{ V}$ , $I_{OUT} = 250\text{ mA}$ , $T_A = 25^\circ\text{C}$	–	90.0	110.0			
$V_{IH}$	ON Input Logic High Voltage	$V_{IN} = 1.5\text{ V to }5.5\text{ V}$	1.15	–	–	V
$V_{IL}$	ON Input Logic Low Voltage	$V_{IN} = 1.8\text{ V to }5.5\text{ V}$	–	–	0.65	V
		$V_{IN} = 1.5\text{ V to }1.8\text{ V}$	–	–	0.60	
$I_{ON}$	ON Input Leakage	$V_{ON} = V_{IN}$ or GND	–	–	1.0	$\mu\text{A}$
$R_{ON\_PD}$	Pull-Down Resistance at ON Pin	$V_{IN} = V_{ON} = 1.5\text{ V to }5.5\text{ V}$ , $T_A = -40^\circ\text{C} - +85^\circ\text{C}$	6.38	7.65	8.86	$\text{M}\Omega$

## TRUE REVERSE CURRENT BLOCKING

$V_{T\_RCB}$	RCB Protection Trip Point	$V_{OUT} - V_{IN}$	–	45	–	mV
$V_{R\_RCB}$	RCB Protection Release Trip Point	$V_{IN} - V_{OUT}$	–	25	–	mV
	RCB Hysteresis		–	70	–	mV
$I_{SD\_OUT}$	$V_{OUT}$ Shutdown Current	$V_{ON} = 0$ , $V_{OUT} = 4.5\text{ V}$ , $V_{IN} = \text{Short to GND}$	–	–	2	$\mu\text{A}$
$t_{RCB\_ON}$	RCB Response Time, Device ON	$V_{OUT} - V_{IN} = 100\text{ mV}$ , $V_{ON} = \text{HIGH}$	–	4	–	$\mu\text{s}$
$t_{RCB\_OFF}$	RCB Response Time, Device OFF	$V_{OUT} - V_{IN} = 100\text{ mV}$ , $V_{ON} = \text{LOW}$	–	2.5	–	$\mu\text{s}$

## DYNAMIC CHARACTERISTICS

$t_{DON}$	Turn-On Delay (Notes 8, 9)	$V_{IN} = 4.5\text{ V}$ , $R_L = 5\ \Omega$ , $C_L = 100\ \mu\text{F}$ , $T_A = 25^\circ\text{C}$	–	1.7	–	ms
$t_R$	$V_{OUT}$ Rise Time (Notes 8, 9)		–	2.7	–	ms
$t_{ON}$	Turn-On Time (Notes 8, 9)		–	4.4	–	ms
$t_{DON}$	Turn-On Delay (Notes 8, 9)	$V_{IN} = 4.5\text{ V}$ , $R_L = 150\ \Omega$ , $C_L = 100\ \mu\text{F}$ , $T_A = 25^\circ\text{C}$	–	1.7	–	ms
$t_R$	$V_{OUT}$ Rise Time (Notes 8, 9)		–	1.5	–	ms
$t_{ON}$	Turn-On Time (Notes 8, 9)		–	3.2	–	ms
$t_{DOFF}$	Turn-Off Delay (Notes 8, 10)	$V_{IN} = 4.5\text{ V}$ , $R_L = 150\ \Omega$ , $C_L = 100\ \mu\text{F}$ , $T_A = 25^\circ\text{C}$	–	1.8	–	ms
$t_F$	$V_{OUT}$ Fall Time (Notes 8, 10)		–	34	–	ms
$t_{OFF}$	Turn-Off Time (Notes 8, 10)		–	35	–	ms

Product parametric performance is indicated in the Electrical Characteristics for the listed test conditions, unless otherwise noted. Product performance may not be indicated by the Electrical Characteristics if operated under different conditions.

7. This parameter is guaranteed by design and characterization; not production tested.

8.  $t_{DON}/t_{DOFF}/t_R/t_F$  are defined in Figure 21.

9.  $t_{ON} = t_R + t_{DON}$ .

10.  $t_{OFF} = t_F + t_{DOFF}$ .

TYPICAL CHARACTERISTICS

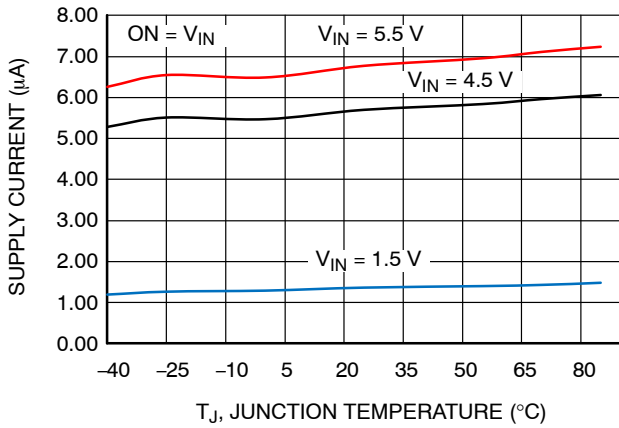

Figure 5. Supply Current vs. Temperature

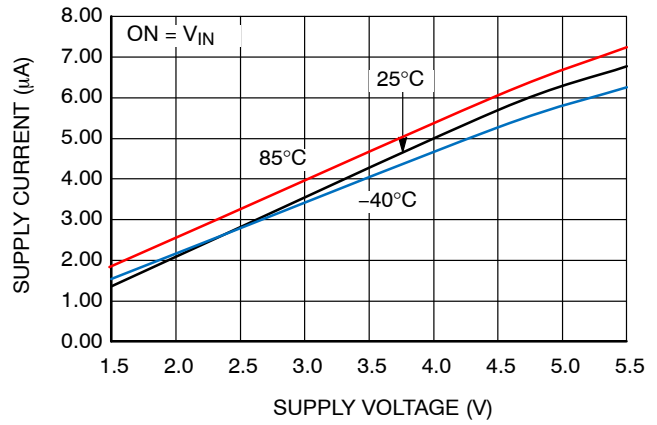

Figure 6. Supply Current vs. Supply Voltage

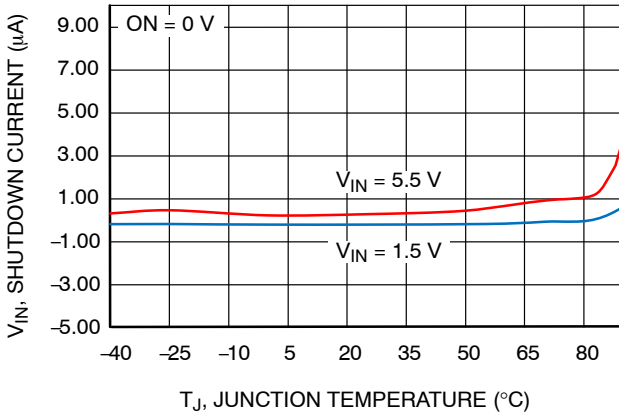

Figure 7. Shutdown Current vs. Temperature

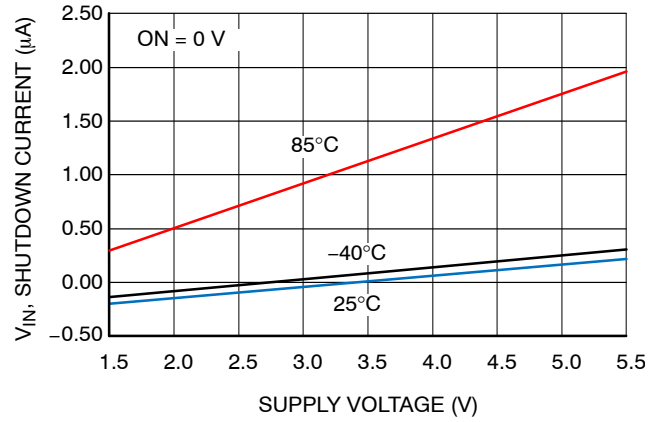

Figure 8. Shutdown Current vs. Supply Voltage

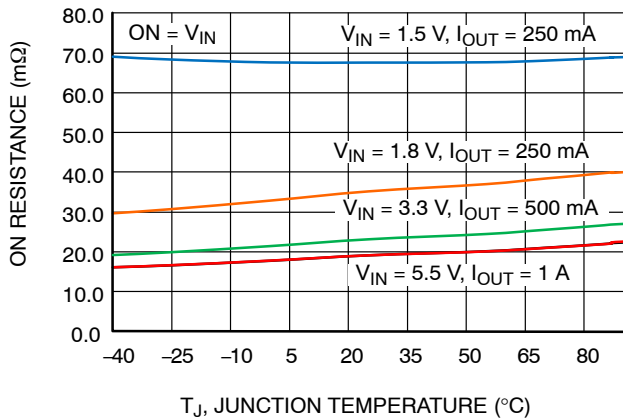

Figure 9.  $R_{ON}$  vs. Temperature

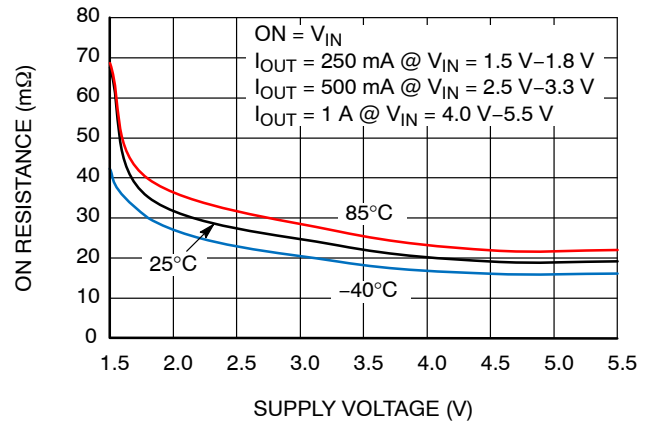

Figure 10.  $R_{ON}$  vs. Supply Voltage

TYPICAL CHARACTERISTICS (continued)

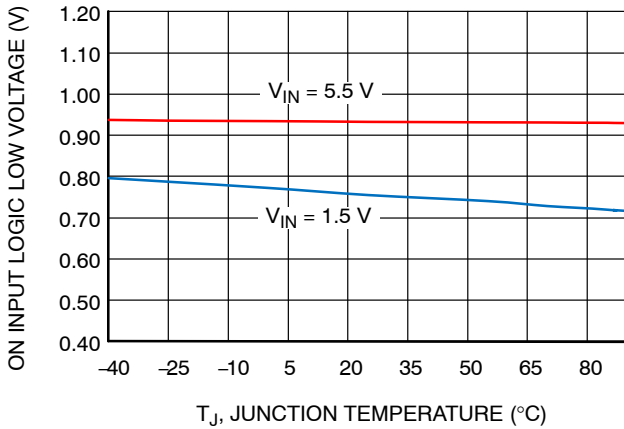

Figure 11.  $V_{IL}$  vs. Temperature

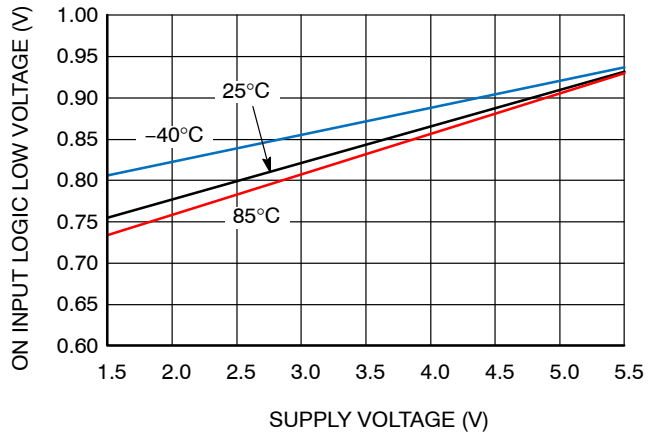

Figure 12.  $V_{IL}$  vs. Supply Voltage

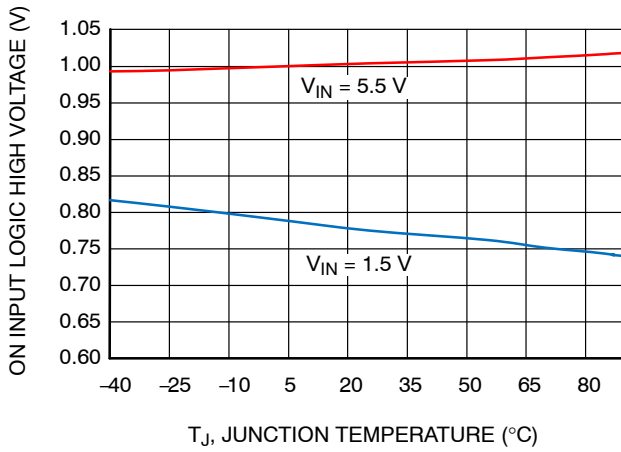

Figure 13.  $V_{IH}$  vs. Temperature

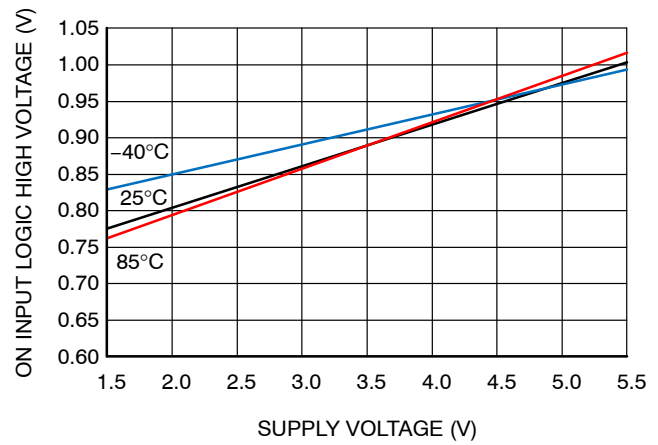

Figure 14.  $V_{IH}$  vs. Supply Voltage

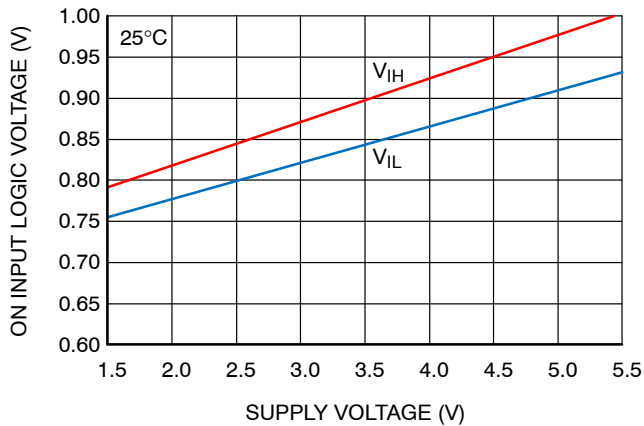

Figure 15. On Pin Threshold vs. Supply Voltage

TYPICAL CHARACTERISTICS (continued)

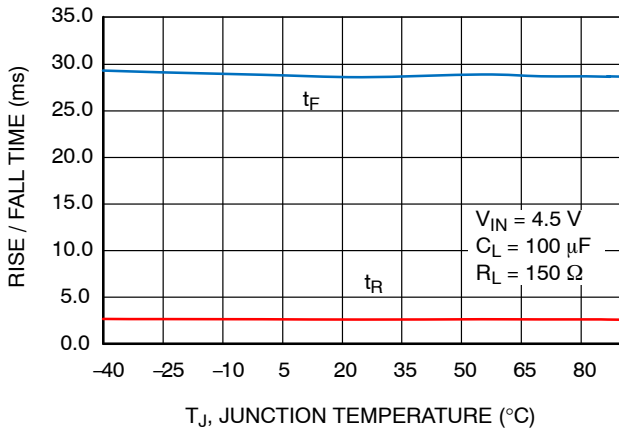

Figure 16.  $t_R$  /  $t_F$  vs. Temperature

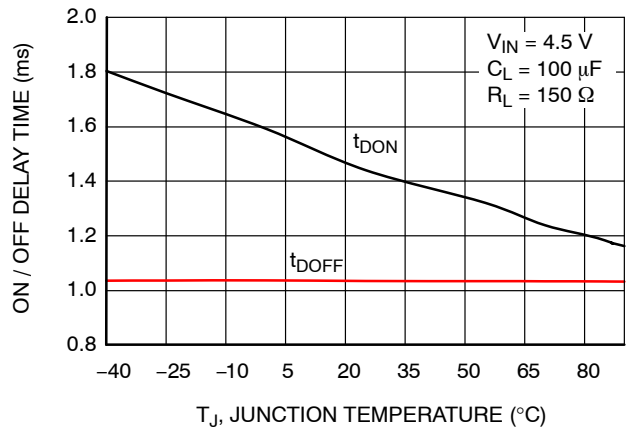

Figure 17.  $t_{DON}$  vs. Temperature

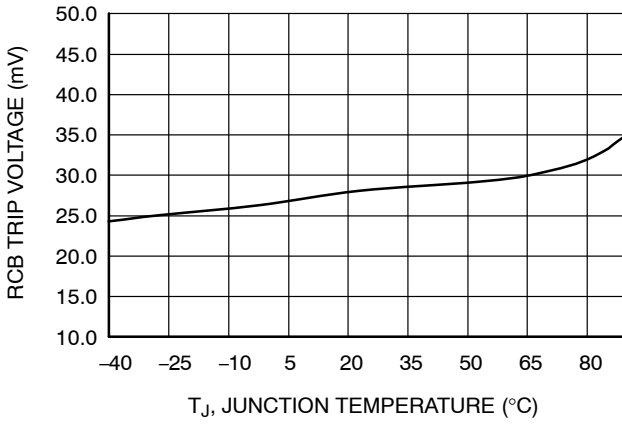

Figure 18. RCB Trip vs. Temperature

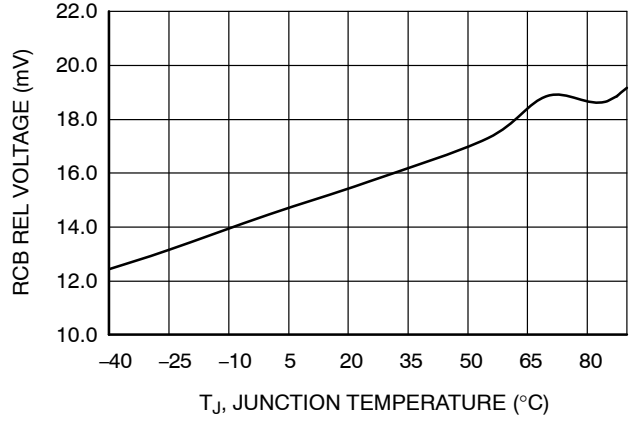

Figure 19. RCB Release vs. Temperature

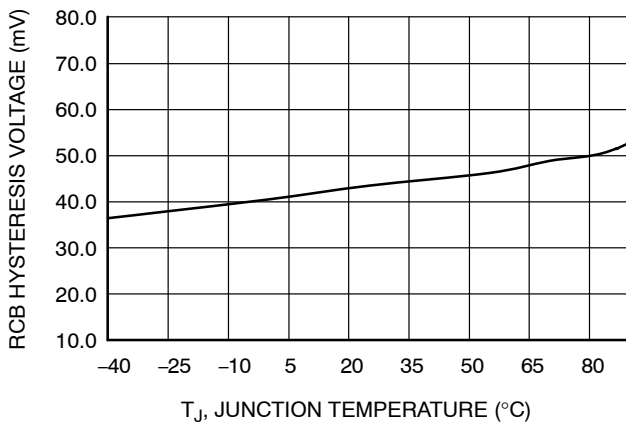

Figure 20. RCB Hysteresis vs. Temperature

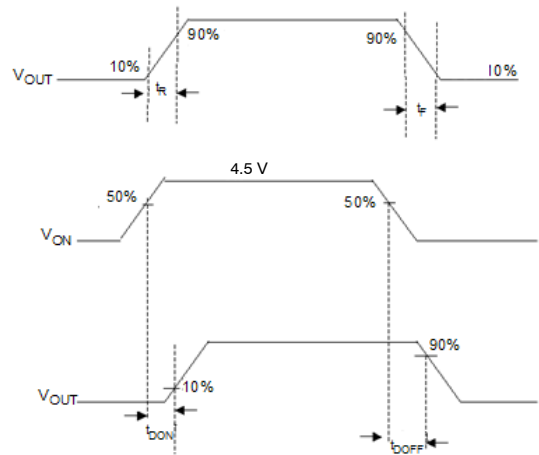

Figure 21. Timing Diagram



TYPICAL CHARACTERISTICS (continued)

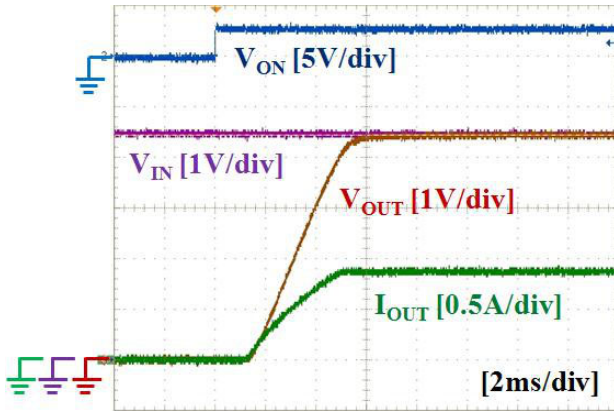

Figure 22. Turn-On Response  
 ( $V_{IN} = 4.5\text{ V}$ ,  $C_{IN} = 10\text{ }\mu\text{F}$ ,  $C_{OUT} = 100\text{ }\mu\text{F}$ ,  $R_L = 5\text{ }\Omega$ )

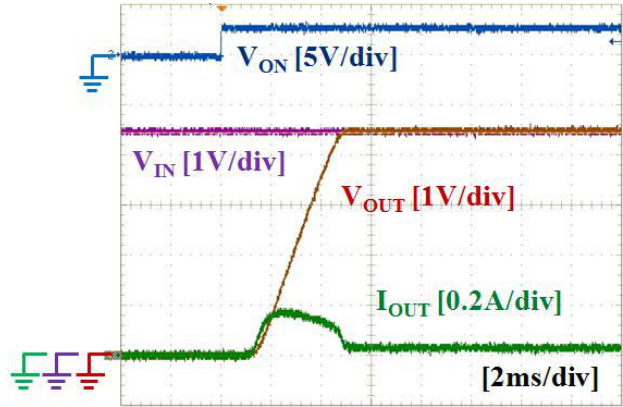

Figure 23. Turn-On Response  
 ( $V_{IN} = 4.5\text{ V}$ ,  $C_{IN} = 10\text{ }\mu\text{F}$ ,  $C_{OUT} = 100\text{ }\mu\text{F}$ ,  $R_L = 150\text{ }\Omega$ )

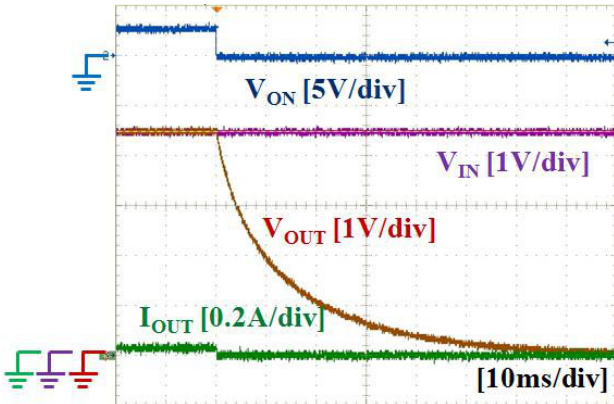

Figure 24. Turn-Off Response  
 ( $V_{IN} = 4.5\text{ V}$ ,  $C_{IN} = 10\text{ }\mu\text{F}$ ,  $C_{OUT} = 100\text{ }\mu\text{F}$ ,  $R_L = 150\text{ }\Omega$ )

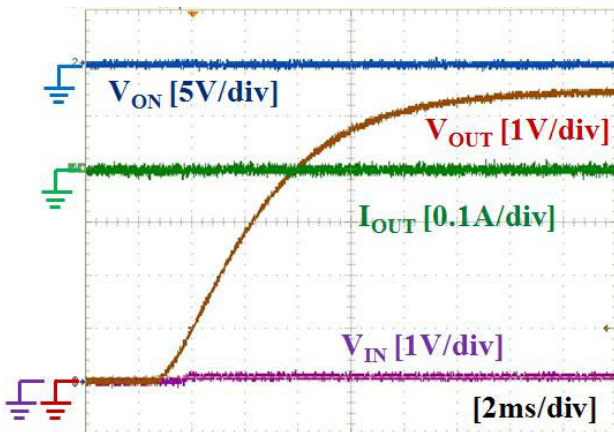

Figure 25. RCB Response During Off  
 ( $V_{IN} = \text{Open}$ ,  $V_{ON} = \text{GND}$ ,  $V_{OUT} = 5.5\text{ V}$ ,  $C_{IN} = 10\text{ }\mu\text{F}$ ,  $C_{OUT} = 100\text{ }\mu\text{F}$ )

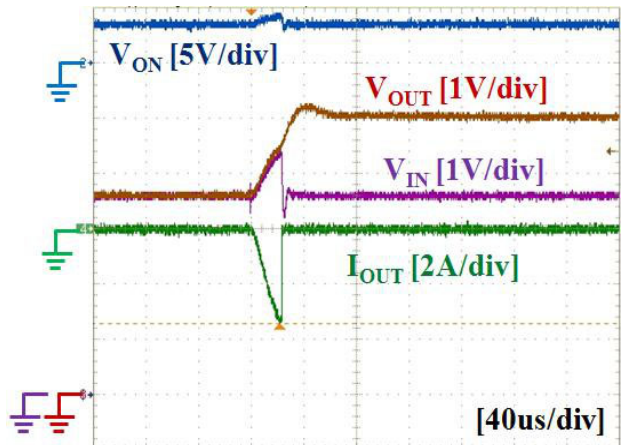

Figure 26. RCB Response During On  
 ( $V_{IN} = V_{ON} = 3.6\text{ V}$ ,  $V_{OUT} = 5\text{ V}$ ,  $C_{IN} = 10\text{ }\mu\text{F}$ ,  $C_{OUT} = 100\text{ }\mu\text{F}$ )

**Operation and Application Description**

The FPF1048 is a low- $R_{ON}$  P-channel load switch with controlled turn-on and True Reverse Current Blocking (TRCB). The core is a 23 m $\Omega$  P-channel MOSFET and controller capable of functioning over a wide input operating range of 1.5 V to 5.5 V. The ON pin, an active-HIGH, GPIO/CMOS-compatible input; controls the state of the switch. TRCB functionality blocks unwanted reverse current during both ON and OFF states when higher  $V_{OUT}$  than  $V_{IN}$  is applied.

**Input Capacitor**

To limit the voltage drop on the input supply caused by transient inrush current when the switch turns on into a discharged load capacitor; a capacitor must be placed between the  $V_{IN}$  and GND pins. At least 1  $\mu$ F ceramic capacitor,  $C_{IN}$ , placed close to the pins is usually sufficient. Higher-value  $C_{IN}$  can be used to reduce the voltage drop in higher-current applications.

**Inrush Current**

Inrush current occurs when the device is turned on. Inrush current is dependent on output capacitance and slew rate control capability, as expressed by:

$$I_{INRUSH} = C_{OUT} \times \frac{V_{IN} - V_{INITIAL}}{t_R} + I_{LOAD} \quad (\text{eq. 1})$$

Where:

- $C_{OUT}$  Output capacitance;
- $t_R$  Slew rate or rise time at  $V_{OUT}$ ;
- $V_{IN}$  Input voltage;
- $V_{INITIAL}$  Initial voltage at  $C_{OUT}$ , usually GND; and
- $I_{LOAD}$  Load current.

Higher inrush current causes higher input voltage drop, depending on the distributed input resistance and input capacitance. High inrush current can cause problems.

FPF1048 has a 2.7 ms of slew rate capability under 4.5  $V_{IN}$  at 1000  $\mu$ F of  $C_{OUT}$  and 5  $\Omega$  of  $R_L$  so inrush current can be minimized and no input voltage drop appears. Table 1 and Figure 27 show the values and actual waveforms with  $C_{IN} = 10 \mu$ F,  $C_{OUT} = 100 \mu$ F, and no load current.

**Table 1. INRUSH CURRENT BY INPUT VOLTAGE**

$V_{IN}$ [V]	$t_R$ [ms]	Inrush Current [mA]	
		Measured	Calculated with 2.7 ms $t_R$
1.5	1.62	76	56
3.3	2.03	140	122
5.0	2.33	196	185

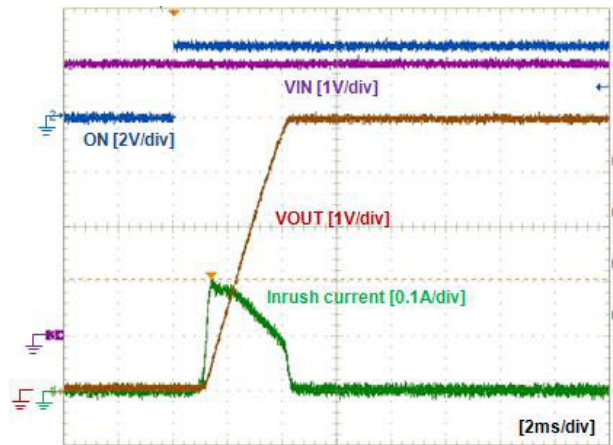

**Figure 27. Inrush Current Waveform, Under 5  $V_{IN}$ ,  $C_{OUT} = 100 \mu$ F, no Load**

**Output Capacitor**

At least 0.1  $\mu$ F capacitor,  $C_{OUT}$ , should be placed between the  $V_{OUT}$  and GND pins. This capacitor prevents parasitic board inductance from forcing  $V_{OUT}$  below GND when the switch is on.

**True Reverse Current Blocking**

The true reverse current blocking feature protects the input source against current flow from output to input regardless of whether the load switch is on or off.

**Board Layout**

For best performance, all traces should be as short as possible. To be most effective, the input and output capacitors should be placed close to the device to minimize the effect that parasitic trace inductance on normal and short-circuit operation. Using wide traces or large copper planes for all pins ( $V_{IN}$ ,  $V_{OUT}$ , ON, and GND) minimizes the parasitic electrical effects and the case-to-ambient thermal impedance.

# FPF1048

## ORDERING INFORMATION

Part Number	Top Mark	Switch $R_{ON}$ (Typical) at 4.5 $V_{IN}$	Input Buffer	Output Discharge	ON Pin Activity	$t_R$	Package
FPF1048BUCX	RA	23 m $\Omega$	CMOS	NA	Active HIGH	2.7 ms	6-Ball, WLCSP with Backside Laminate, 2 x 3 Array, 0.5 mm Pitch, 300 $\mu$ m Balls

## PRODUCT-SPECIFIC DIMENSIONS

Product	D	E	X	Y
FPF1048BUCX	1460 $\mu$ m $\pm$ 30 $\mu$ m	960 $\mu$ m $\pm$ 30 $\mu$ m	230 $\mu$ m	230 $\mu$ m

IntelliMAX is trademark of Semiconductor Components Industries, LLC dba "onsemi" or its affiliates and/or subsidiaries in the United States and/or other countries.

**WLCSP6 1.46x0.96x0.582**  
CASE 567RM  
ISSUE O

DATE 30 NOV 2016

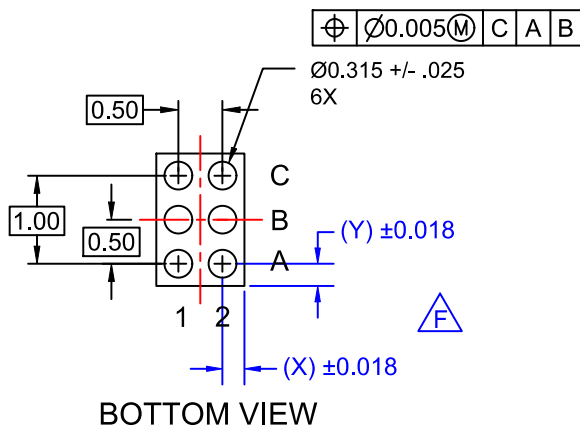
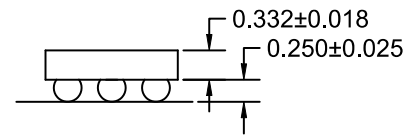
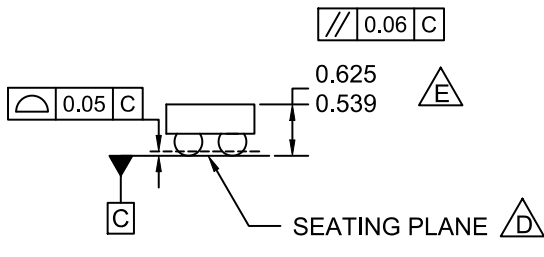
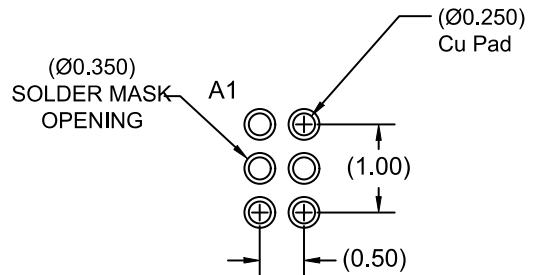
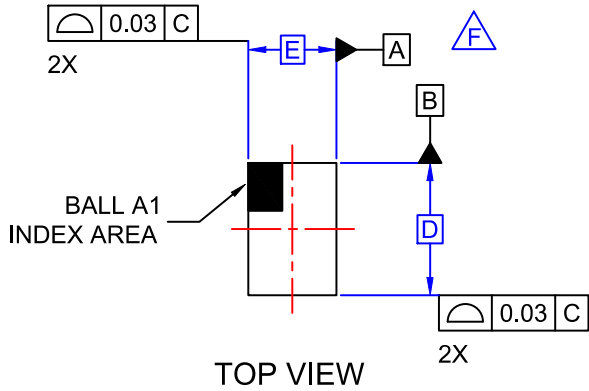

**NOTES:**

- A. NO JEDEC REGISTRATION APPLIES.
- B. DIMENSIONS ARE IN MILLIMETERS.
- C. DIMENSIONS AND TOLERANCE PER ASMEY14.5M, 1994.
- △** DATUM C IS DEFINED BY THE SPHERICAL CROWNS OF THE BALLS.
- △** PACKAGE NOMINAL HEIGHT IS 582 MICRONS ±43 MICRONS (539-625 MICRONS).
- △** FOR DIMENSIONS D, E, X, AND Y SEE PRODUCT DATASHEET.

<b>DOCUMENT NUMBER:</b>	<b>98AON16579G</b>	Electronic versions are uncontrolled except when accessed directly from the Document Repository. Printed versions are uncontrolled except when stamped "CONTROLLED COPY" in red.
<b>DESCRIPTION:</b>	<b>WLCSP6 1.46x0.96x0.582</b>	<b>PAGE 1 OF 1</b>

ON Semiconductor and are trademarks of Semiconductor Components Industries, LLC dba ON Semiconductor or its subsidiaries in the United States and/or other countries. ON Semiconductor reserves the right to make changes without further notice to any products herein. ON Semiconductor makes no warranty, representation or guarantee regarding the suitability of its products for any particular purpose, nor does ON Semiconductor assume any liability arising out of the application or use of any product or circuit, and specifically disclaims any and all liability, including without limitation special, consequential or incidental damages. ON Semiconductor does not convey any license under its patent rights nor the rights of others.

**onsemi**, **Onsemi**, and other names, marks, and brands are registered and/or common law trademarks of Semiconductor Components Industries, LLC dba "**onsemi**" or its affiliates and/or subsidiaries in the United States and/or other countries. **onsemi** owns the rights to a number of patents, trademarks, copyrights, trade secrets, and other intellectual property. A listing of **onsemi**'s product/patent coverage may be accessed at [www.onsemi.com/site/pdf/Patent-Marking.pdf](http://www.onsemi.com/site/pdf/Patent-Marking.pdf). **onsemi** reserves the right to make changes at any time to any products or information herein, without notice. The information herein is provided "as-is" and **onsemi** makes no warranty, representation or guarantee regarding the accuracy of the information, product features, availability, functionality, or suitability of its products for any particular purpose, nor does **onsemi** assume any liability arising out of the application or use of any product or circuit, and specifically disclaims any and all liability, including without limitation special, consequential or incidental damages. Buyer is responsible for its products and applications using **onsemi** products, including compliance with all laws, regulations and safety requirements or standards, regardless of any support or applications information provided by **onsemi**. "Typical" parameters which may be provided in **onsemi** data sheets and/or specifications can and do vary in different applications and actual performance may vary over time. All operating parameters, including "Typicals" must be validated for each customer application by customer's technical experts. **onsemi** does not convey any license under any of its intellectual property rights nor the rights of others. **onsemi** products are not designed, intended, or authorized for use as a critical component in life support systems or any FDA Class 3 medical devices or medical devices with a same or similar classification in a foreign jurisdiction or any devices intended for implantation in the human body. Should Buyer purchase or use **onsemi** products for any such unintended or unauthorized application, Buyer shall indemnify and hold **onsemi** and its officers, employees, subsidiaries, affiliates, and distributors harmless against all claims, costs, damages, and expenses, and reasonable attorney fees arising out of, directly or indirectly, any claim of personal injury or death associated with such unintended or unauthorized use, even if such claim alleges that **onsemi** was negligent regarding the design or manufacture of the part. **onsemi** is an Equal Opportunity/Affirmative Action Employer. This literature is subject to all applicable copyright laws and is not for resale in any manner.

## PUBLICATION ORDERING INFORMATION

### LITERATURE FULFILLMENT:

Email Requests to: [orderlit@onsemi.com](mailto:orderlit@onsemi.com)

**onsemi Website:** [www.onsemi.com](http://www.onsemi.com)

### TECHNICAL SUPPORT

**North American Technical Support:**

Voice Mail: 1 800-282-9855 Toll Free USA/Canada

Phone: 011 421 33 790 2910

**Europe, Middle East and Africa Technical Support:**

Phone: 00421 33 790 2910

For additional information, please contact your local Sales Representative