

Bridge Rectifiers

GBU6A - GBU6M

Features

- Glass–Passivated Junction
- Surge Overload Rating: 175 A Peak
- Reliable Low–Cost Construction Utilizing Molded Plastic Technique
- Ideal for Printed Circuit Board
- UL Certified: UL #E258596

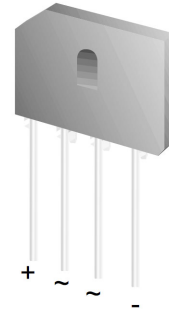

SIP4
CASE 127EL

PACKAGE MARKING AND ORDERING INFORMATION

Part Number	Marking	Package	Packing Method
GBU6A	GBU6A	GBU 4L	Rail
GBU6B	GBU6B		
GBU6D	GBU6D		
GBU6G	GBU6G		
GBU6J	GBU6J		
GBU6K	GBU6K		
GBU6M	GBU6M		

MARKING DIAGRAM

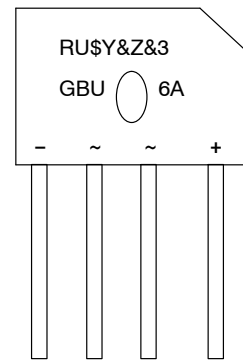

- | | |
|-------|-------------------------|
| RU | = UL Marking |
| \$Y | = ON Semiconductor Logo |
| &Z | = Assembly Plant Code |
| &3 | = Numeric Date Code |
| GBU6A | = Specific Device Code |

GBU6A – GBU6M

ABSOLUTE MAXIMUM RATINGS ($T_A = 25^\circ\text{C}$ unless otherwise noted) (Note 1)

Symbol	Parameter	Value							Units	
		6A	6B	6D	6G	6J	6K	6M		
V_{RRM}	Maximum Repetitive Reverse Voltage	50	100	200	400	600	800	1000	V	
V_{RMS}	Maximum RMS Bridge Input Voltage	35	70	140	280	420	560	700	V	
V_R	DC Reverse Voltage (Rated V_R)	50	100	200	400	600	800	1000	V	
$I_{F(AV)}$	Average Rectified Forward Current	$T_A = 100^\circ\text{C}$							6.0	A
I_{FSM}	Non-Repetitive Peak Forward Surge Current 8.3 ms Single Half-Sine-Wave	175							A	
T_{STG}	Storage Temperature Range	-55 to +150							$^\circ\text{C}$	
T_J	Operating Junction Temperature	-55 to +150							$^\circ\text{C}$	

Stresses exceeding those listed in the Maximum Ratings table may damage the device. If any of these limits are exceeded, device functionality should not be assumed, damage may occur and reliability may be affected.

1. These ratings are limiting values above which the serviceability of any semiconductor device may be impaired.

THERMAL CHARACTERISTICS ($T_A = 25^\circ\text{C}$ unless otherwise noted)

Symbol	Parameter	Value	Units
P_D	Power Dissipation	12	W
$R_{\theta JA}$	Thermal Resistance per Leg, Junction to Ambient (Note 2)	18.6	$^\circ\text{C}/\text{W}$
$R_{\theta JL}$	Thermal Resistance per Leg, Junction to Lead (Note 3)	3.1	$^\circ\text{C}/\text{W}$

2. Device mounted on PCB with 0.5×0.5 inch (12×12 mm)

3. Device mounted on Al plate with $2.6 \times 1.4 \times 0.06$ inch ($6.5 \times 3.5 \times 0.15$ cm)

ELECTRICAL CHARACTERISTICS ($T_J = 25^\circ\text{C}$ unless otherwise noted)

Symbol	Parameter	Value	Units	
V_F	Forward Voltage, per Element	6.0 A	1.0	V
I_R	Reverse Current, per Element at Rated V_R	$T_A = 25^\circ\text{C}$	5.0	μA
		$T_A = 125^\circ\text{C}$	500	μA
I^2t	I^2t Rating for Fusing	$t < 8.35$ ms	127	A^2s

Product parametric performance is indicated in the Electrical Characteristics for the listed test conditions, unless otherwise noted. Product performance may not be indicated by the Electrical Characteristics if operated under different conditions.

GBU6A – GBU6M

TYPICAL PERFORMANCE CHARACTERISTICS

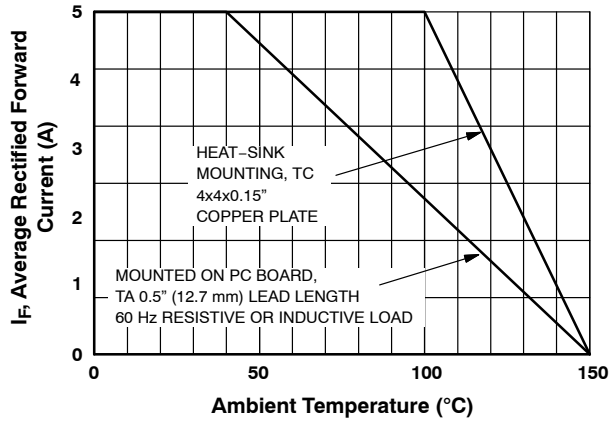

Figure 1. Forward Current Derating Curve

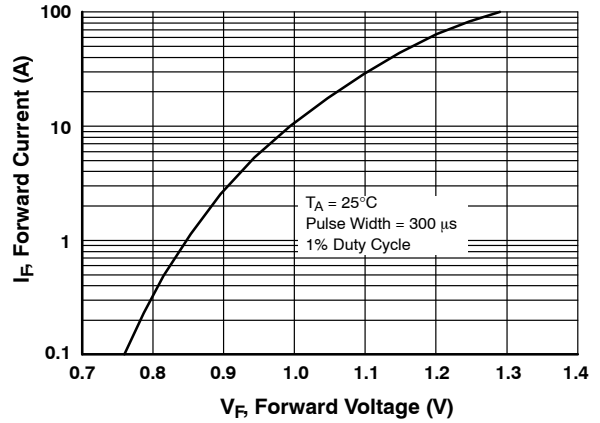

Figure 2. Forward Voltage Characteristics

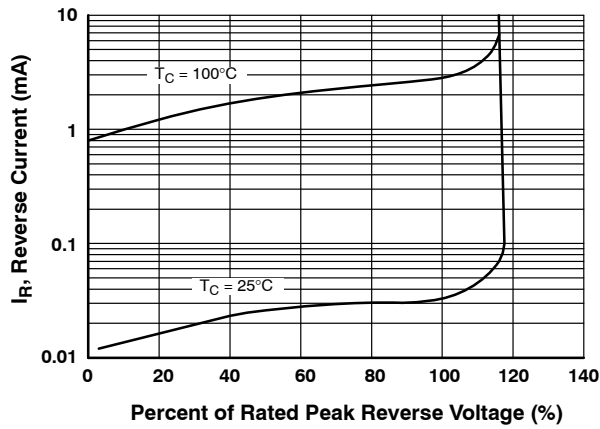

Figure 3. Reverse Current vs. Reverse Voltage

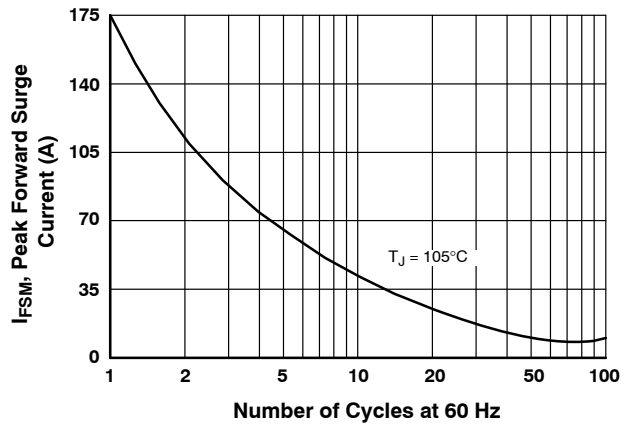

Figure 4. Non-Repetitive Surge Current

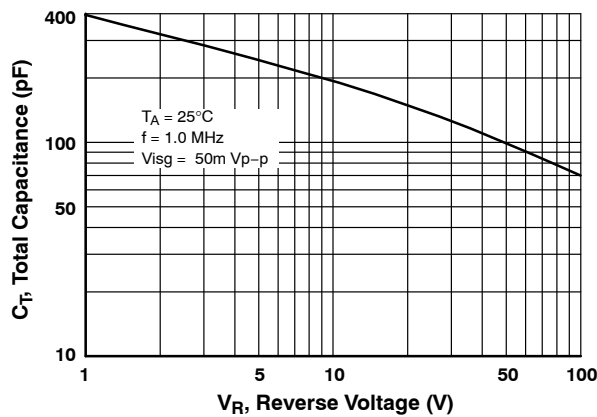
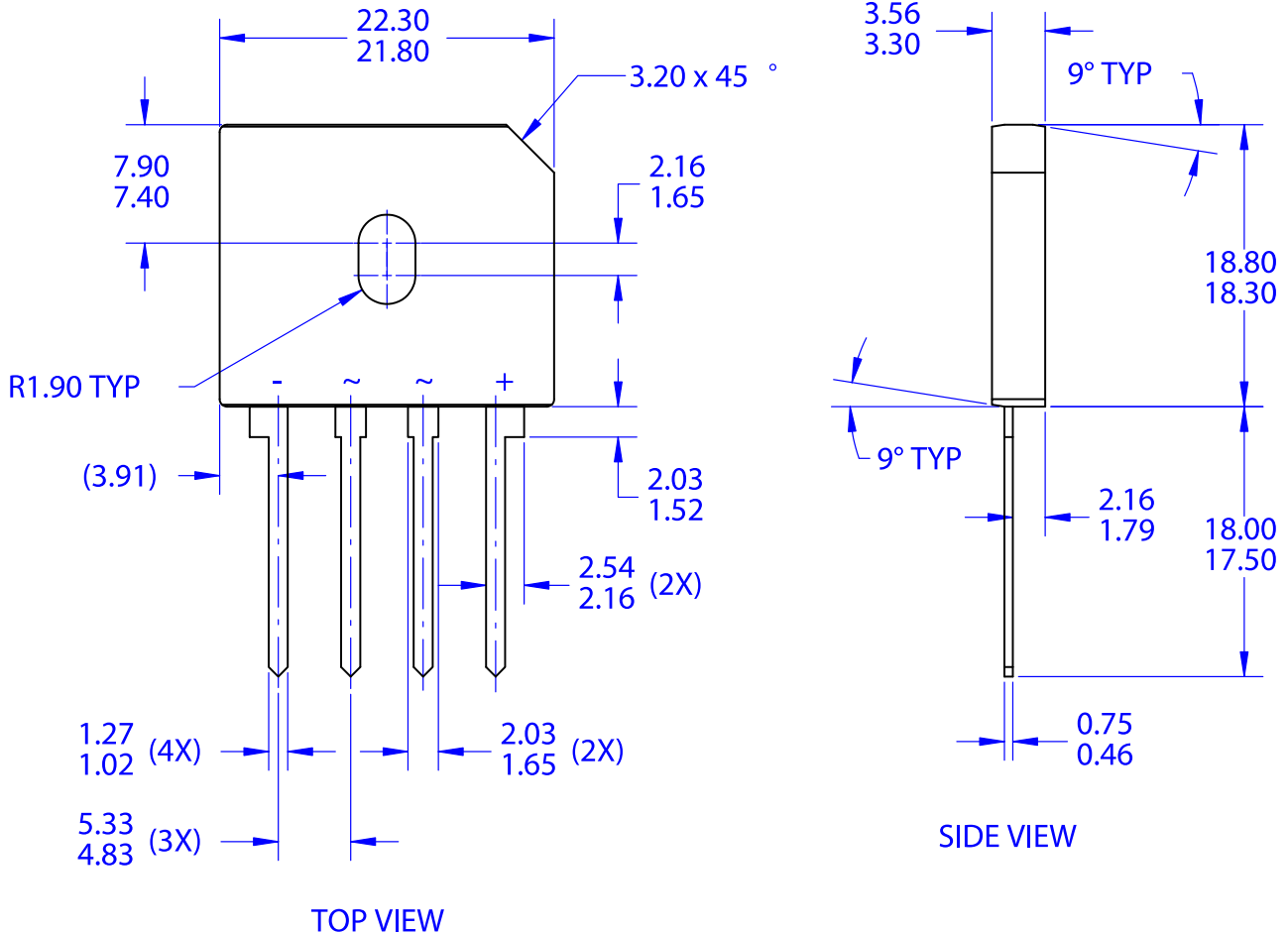

Figure 5. Total Capacitance

MECHANICAL CASE OUTLINE
PACKAGE DIMENSIONS

SIP4 22.05x18.55
CASE 127EL
ISSUE 0

DATE 31 DEC 2016



- NOTES:
- A. NO INDUSTRY STANDARD APPLIES TO THIS PACKAGE
 - B. ALL DIMENSIONS ARE IN MILLIMETERS
 - C. DIMENSIONS ARE EXCLUSIVE OF BURRS, MOLD FLASH AND TIE BAR PROTRUSIONS.
 - D. DIMENSIONS AND TOLERANCES AS PER ASME Y14.5-2009

DOCUMENT NUMBER:	98AON13717G	Electronic versions are uncontrolled except when accessed directly from the Document Repository. Printed versions are uncontrolled except when stamped "CONTROLLED COPY" in red.
DESCRIPTION:	SIP4 22.05x18.55	PAGE 1 OF 1

ON Semiconductor and **ON** are trademarks of Semiconductor Components Industries, LLC dba ON Semiconductor or its subsidiaries in the United States and/or other countries. ON Semiconductor reserves the right to make changes without further notice to any products herein. ON Semiconductor makes no warranty, representation or guarantee regarding the suitability of its products for any particular purpose, nor does ON Semiconductor assume any liability arising out of the application or use of any product or circuit, and specifically disclaims any and all liability, including without limitation special, consequential or incidental damages. ON Semiconductor does not convey any license under its patent rights nor the rights of others.

onsemi, **Onsemi**, and other names, marks, and brands are registered and/or common law trademarks of Semiconductor Components Industries, LLC dba "**onsemi**" or its affiliates and/or subsidiaries in the United States and/or other countries. **onsemi** owns the rights to a number of patents, trademarks, copyrights, trade secrets, and other intellectual property. A listing of **onsemi**'s product/patent coverage may be accessed at www.onsemi.com/site/pdf/Patent-Marking.pdf. **onsemi** reserves the right to make changes at any time to any products or information herein, without notice. The information herein is provided "as-is" and **onsemi** makes no warranty, representation or guarantee regarding the accuracy of the information, product features, availability, functionality, or suitability of its products for any particular purpose, nor does **onsemi** assume any liability arising out of the application or use of any product or circuit, and specifically disclaims any and all liability, including without limitation special, consequential or incidental damages. Buyer is responsible for its products and applications using **onsemi** products, including compliance with all laws, regulations and safety requirements or standards, regardless of any support or applications information provided by **onsemi**. "Typical" parameters which may be provided in **onsemi** data sheets and/or specifications can and do vary in different applications and actual performance may vary over time. All operating parameters, including "Typicals" must be validated for each customer application by customer's technical experts. **onsemi** does not convey any license under any of its intellectual property rights nor the rights of others. **onsemi** products are not designed, intended, or authorized for use as a critical component in life support systems or any FDA Class 3 medical devices or medical devices with a same or similar classification in a foreign jurisdiction or any devices intended for implantation in the human body. Should Buyer purchase or use **onsemi** products for any such unintended or unauthorized application, Buyer shall indemnify and hold **onsemi** and its officers, employees, subsidiaries, affiliates, and distributors harmless against all claims, costs, damages, and expenses, and reasonable attorney fees arising out of, directly or indirectly, any claim of personal injury or death associated with such unintended or unauthorized use, even if such claim alleges that **onsemi** was negligent regarding the design or manufacture of the part. **onsemi** is an Equal Opportunity/Affirmative Action Employer. This literature is subject to all applicable copyright laws and is not for resale in any manner.

PUBLICATION ORDERING INFORMATION

LITERATURE FULFILLMENT:

Email Requests to: orderlit@onsemi.com

onsemi Website: www.onsemi.com

TECHNICAL SUPPORT

North American Technical Support:

Voice Mail: 1 800-282-9855 Toll Free USA/Canada

Phone: 011 421 33 790 2910

Europe, Middle East and Africa Technical Support:

Phone: 00421 33 790 2910

For additional information, please contact your local Sales Representative