

Smart LiB Gauge Battery Fuel Gauge LSI For 1-Cell Lithium-ion/ Polymer (Li+)



ON Semiconductor®

www.onsemi.com

LC709203F

Overview

LC709203F is a Fuel Gauge for a single lithium ion/polymer battery. It is part of our *Smart LiB Gauge* family of Fuel Gauges which measure the battery RSOC (Relative State Of Charge) using its unique algorithm called **HG-CVR**. The **HG-CVR** algorithm eliminates the use of a sense resistor and provides accurate RSOC information even under unstable conditions (e.g. changes of battery; temperature, loading, aging and self-discharge). An accurate RSOC contributes to the operating time of portable devices.

LC709203F is available in two small packages realizing the industries smallest PCB footprint for the complete solution. It has minimal parameters to be set by the user enabling simple, quick setup and operation.

Features

- **HG-CVR** Algorithm Technology
 - ◆ No External Sense Resistor
 - ◆ 2.8% Accuracy of RSOC
 - ◆ Accurate RSOC of Aging Battery
 - ◆ Automatic Convergence of Error
 - ◆ Adjustment for the Parasitic Impedance around the Battery
 - ◆ Simple and Quick Setup
- Low Power Consumption
 - ◆ 3 μ A Operational Mode
- Precision Voltage Measurement
 - ◆ ± 7.5 mV
- Precision Timer
 - ◆ $\pm 3.5\%$
- Alerts for Low RSOC and/or Low Voltage
- Temperature Compensation
 - ◆ Sense Thermistor Input
 - ◆ Via I²C
- Detect Battery Insertion
- I²C Interface (up to 400 kHz Supported)
- These Devices are Pb-Free, Halogen Free/BFR Free and are RoHS Compliant

Applications

- Wireless Handsets
- Smartphones/PDA Devices
- MP3 Players
- Digital Cameras
- Portable Game Players
- USB-related Devices

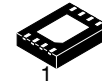

WDFN8
CASE 509AF



WLCSP9
CASE 567JH

MARKING DIAGRAMS

WDFN8

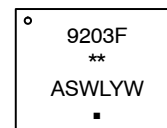

9203F** = Specific Device Code
 ** = 01 (LC709203FQH-01TWG)
 02 (LC709203FQH-02TWG)
 03 (LC709203FQH-03TWG)
 04 (LC709203FQH-04TWG)
 AS = Assembly Location
 WL = Lot Number
 YW = Work Week
 ■ = Pb-Free Package

(Note: Microdot may be in either location)

WLCSP9

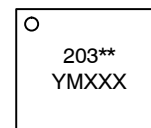

203** = Specific Device Code
 ** = 01 (LC709203FXE-01MH)
 02 (LC709203FXE-02MH)
 03 (LC709203FXE-03MH)
 04 (LC709203FXE-04MH)
 05 (LC709203FXE-05MH)
 Y = Year
 M = Month Code
 XXX = Lot Number

ORDERING INFORMATION

See detailed ordering and shipping information on page 19 of this data sheet.

LC709203F

Application Circuit Example

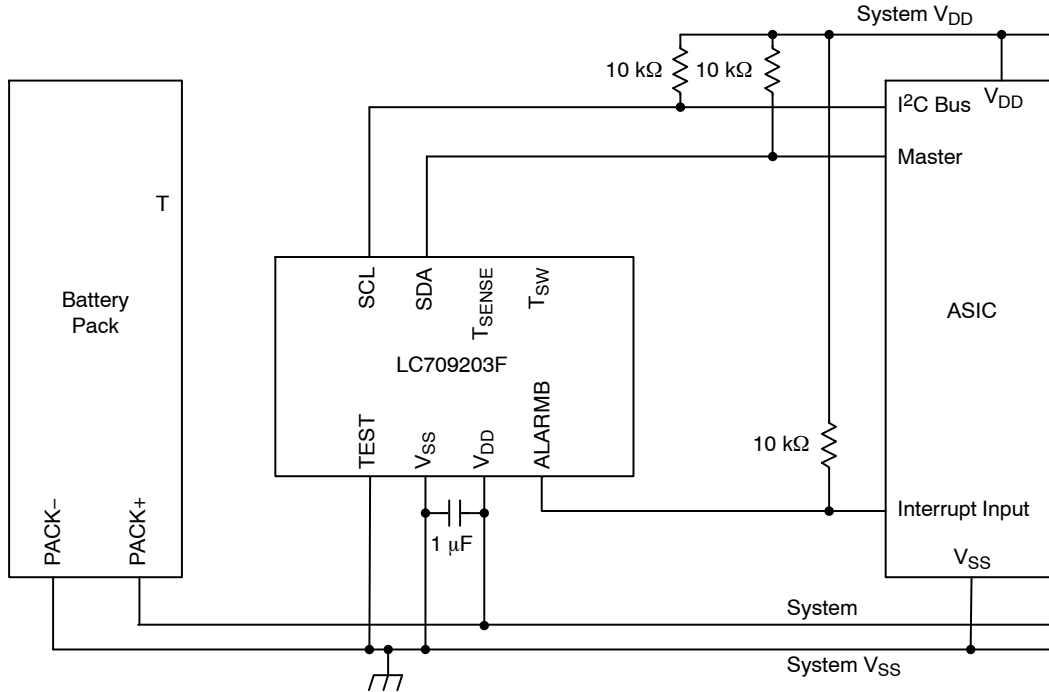

Figure 1. Example of an Application Schematic using LC709203F (Temperature Input via I²C)

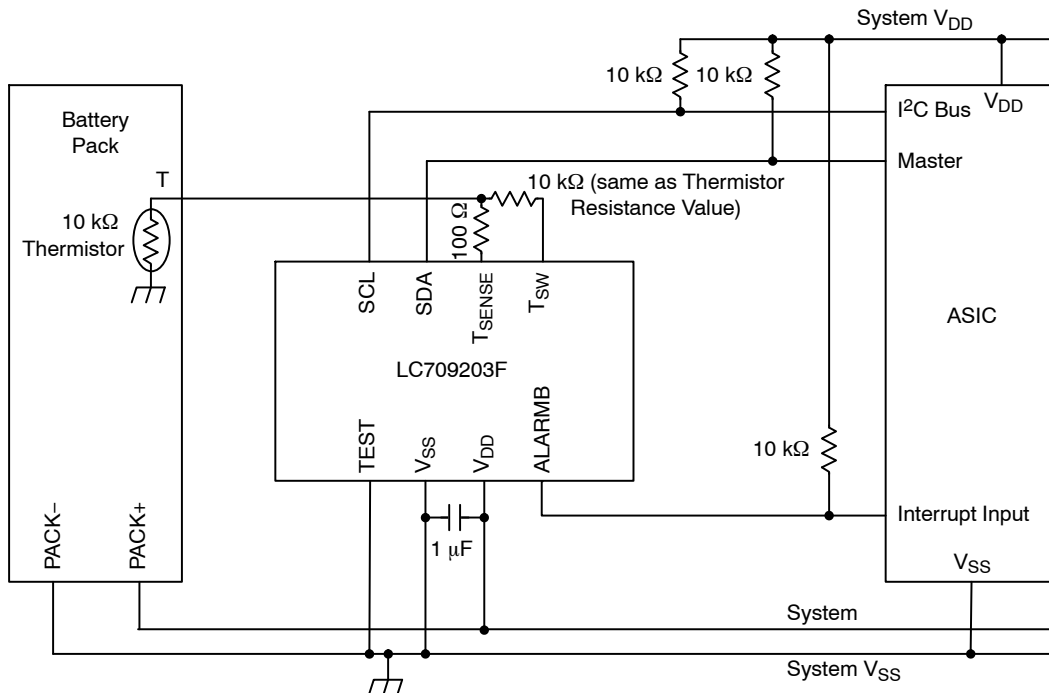

Figure 2. Example of an Application Schematic using LC709203F (The Temperature is Measured Directly by a Thermistor)

LC709203F

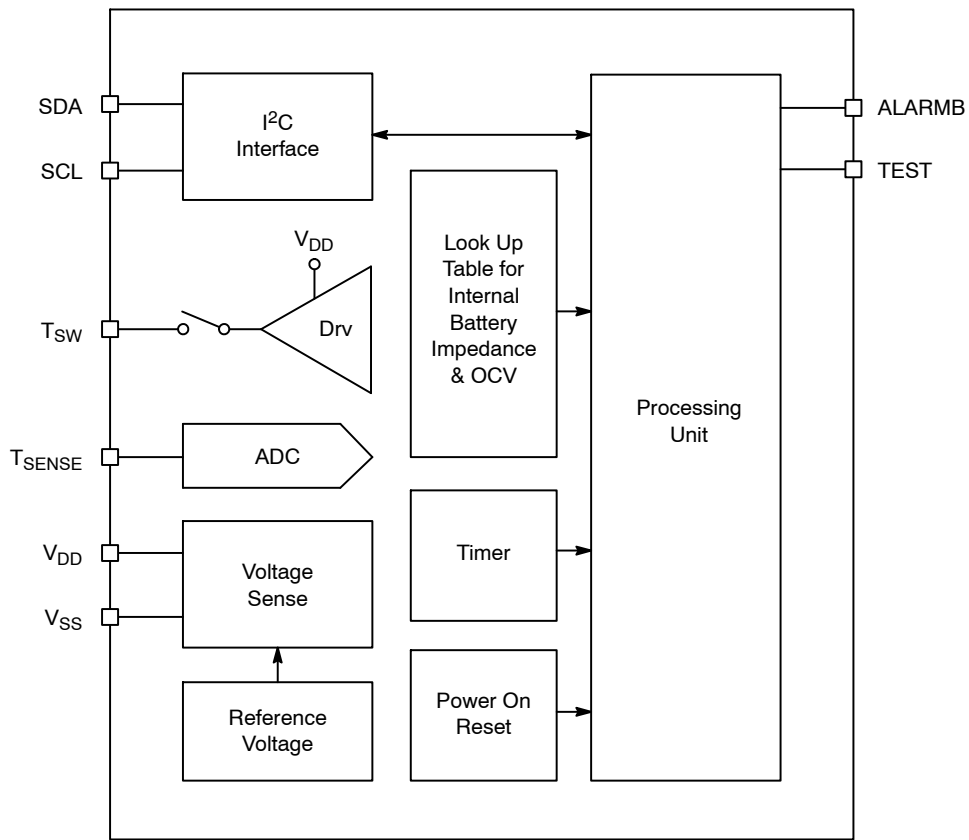
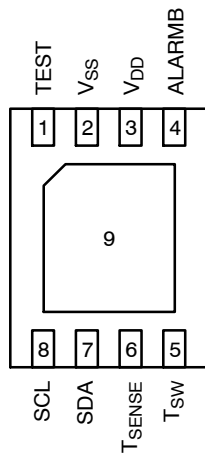

Figure 3. Simplified Block Diagram

WDFN8 3x4, 065P
 "Pb-Free, Halogen Free Type"
 (Bottom View)



WLCSP9 1.60x1.76
 "Pb-Free, Halogen Free Type"
 (Bottom View)

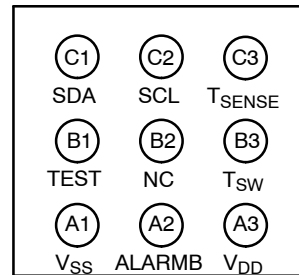

Figure 4. Pin Assignment

LC709203F

Table 1. PIN FUNCTION

WDFN8	WLP9	Pin Name	I/O	Description
1	B1	TEST	I	Connect this pin to V _{SS} .
2	A1	V _{SS}	–	Connect this pin to the battery's negative (–) pin.
3	A3	V _{DD}	–	Connect this pin to the battery's positive (+) pin.
4	A2	ALARMB	O	This pin indicates alarm by low output(open drain). Pull-up must be done externally. Alarm conditions are specified by registers (0x13 or 0x14). Connect this pin to V _{SS} when not in use.
5	B3	T _{SW}	O	Power supply output for thermistor. This pin goes HIGH during temperature read operation. Resistance value of TSW (for thermistor pull-up) must be the same value as the thermistor. (Note 1)
6	C3	T _{SENSE}	I	Thermistor sense input. If you connect this pin to thermistor, insert 100 Ω resistance between them for ESD. (Note 1)
7	C1	SDA	I/O	I ² C Data pin (open drain). Pull-up must be done externally.
8	C2	SCL	I/O	I ² C Clock pin (open drain). Pull-up must be done externally.
–	B2	NC	–	Don't care.
9	–	Exposed PAD	–	Don't care.

1. T_{SW} and T_{SENSE} must be disconnected as Figure 1 when not in use.

Table 2. ABSOLUTE MAXIMUM RATINGS (T_A = 25°C, V_{SS} = 0 V)

Parameter	Symbol	Pin/Remarks	Conditions	V _{DD} (V)	Specification			Unit
					Min	Typ	Max	
Maximum Supply Voltage	V _{DD max}	V _{DD}		–	–0.3	–	+6.5	V
Input Voltage	V _I (1)	T _{SENSE}		–	–0.3	–	V _{DD} + 0.3	
Output Voltage	V _o (1)	T _{SW}		–	–0.3	–	V _{DD} + 0.3	
	V _o (2)	ALARMB		–	–0.3	–		
Input/Output Voltage	V _{IO} (1)	SDA, SCL		–	–0.3	–	+5.5	
Allowable Power Dissipation	P _{d max}	WDFN8	T _A = –40 to +85°C	–	–	–	480	mW
		WLP9		–	–	–	210	
Operating Ambient Temperature	T _{opr}			–	–40	–	+85	°C
Storage Ambient Temperature	T _{stg}			–	–55	–	+125	

Stresses exceeding those listed in the Maximum Ratings table may damage the device. If any of these limits are exceeded, device functionality should not be assumed, damage may occur and reliability may be affected.

Table 3. ALLOWABLE OPERATING CONDITIONS (T_A = –40 to +85°C, V_{SS} = 0 V)

Parameter	Symbol	Pin/Remarks	Conditions	V _{DD} (V)	Specification			Unit
					Min	Typ	Max	
Operating Supply Voltage	V _{DD} (1)	V _{DD}		–	2.5	–	4.5	V
High Level Input Voltage	V _{IH} (1)	T _{SENSE}		2.5 to 4.5	0.7 V _{DD}	–	V _{DD}	
	V _{IH} (2)	ALARMB, SDA, SCL		2.5 to 4.5	1.4	–	–	
Low Level Input Voltage	V _{IL} (1)	T _{SENSE}		2.5 to 4.5	V _{SS}	–	0.25 V _{DD}	
	V _{IL} (2)	ALARMB, SDA, SCL		2.5 to 4.5	–	–	0.5	

Functional operation above the stresses listed in the Recommended Operating Ranges is not implied. Extended exposure to stresses beyond the Recommended Operating Ranges limits may affect device reliability.

LC709203F

Table 4. ELECTRICAL CHARACTERISTICS ($T_A = -40$ to $+85^\circ\text{C}$, $V_{SS} = 0$ V)

Parameter	Symbol	Pin/Remarks	Conditions	V_{DD} (V)	Specification			Unit
					Min	Typ	Max	
High Level Input Current	I_{IH} (1)	SDA, SCL	$V_{IN} = V_{DD}$ (including output transistor off leakage current)	2.5 to 4.5	-	-	1	μA
Low Level Input Current	I_{IL} (1)	SDA, SCL	$V_{IN} = V_{SS}$ (including output transistor off leakage current)	2.5 to 4.5	-1	-	-	
High Level Output Voltage	V_{OH} (1)	T_{SW}	$I_{OH} = -0.4$ mA	3.0 to 4.5	$V_{DD} - 0.4$	-	-	V
	V_{OH} (2)		$I_{OH} = -0.2$ mA	2.5 to 4.5	$V_{DD} - 0.4$	-	-	
Low Level Output Voltage	V_{OL} (1)	T_{SW} , ALARMB, SDA, SCL	$I_{OL} = 3.0$ mA	3.0 to 4.5	-	-	0.4	
	V_{OL} (2)		$I_{OL} = 1.3$ mA	2.5 to 4.5	-	-	0.4	
Hysteresis Voltage	V_{HYS} (1)	SDA, SCL		2.5 to 4.5	-	$0.1 V_{DD}$	-	
Pin Capacitance	CP	All pins	Pins other than the pin under test $V_{IN} = V_{SS}$ $T_A = 25^\circ\text{C}$	2.5 to 4.5	-	10	-	pF
Reset Release Voltage (Note 2)	V_{RR}	V_{DD}			-	-	2.4	V
Initialization Time after Reset Release (Note 2)	T_{INIT}			2.4 to 4.5	-	-	90	ms
Auto Sleep Set Time	T_{ATS}			2.4 to 4.5	-	1	1.2	s
Time Measurement Accuracy	T_{ME}		$T_A = -20^\circ\text{C}$ to $+70^\circ\text{C}$	2.5 to 4.5	-3.5	-	+3.5	%
Consumption Current (Note 3)	I_{DD} (1)	V_{DD}	Operational mode	2.5 to 4.5	-	3	4.5	μA
	I_{DD} (2)		Sleep mode	2.5 to 4.5	-	1	2	
Voltage Measurement Accuracy	V_{ME} (1)	V_{DD}	$T_A = +25^\circ\text{C}$	3.6	-7.5	-	+7.5	mV/cell
	V_{ME} (2)		$T_A = -20^\circ\text{C}$ to $+70^\circ\text{C}$	2.5 to 4.5	-20	-	+20	

Product parametric performance is indicated in the Electrical Characteristics for the listed test conditions, unless otherwise noted. Product performance may not be indicated by the Electrical Characteristics if operated under different conditions.

2. Once V_{DD} voltage exceeds over the V_{RR} , this LSI will release RESET status. And the LSI goes into Sleep mode T_{INIT} after it.

3. Consumption current is a value in the range of -20°C to $+70^\circ\text{C}$.

LC709203F

Table 5. I²C SLAVE CHARACTERISTICS ($T_A = -40$ to $+85^\circ\text{C}$, $V_{SS} = 0$ V)

Parameter	Symbol	Pin/Remarks	Conditions	V _{DD} (V)	Specification		Unit
					Min	Max	
Clock Frequency	T _{SCL}	SCL		2.5 to 4.5	-	400	kHz
Bus Free Time between STOP Condition and START Condition	T _{BUF}	SCL, SDA	(See Figure 5)		1.3	-	μs
Hold Time START Condition. First clock pulse is generated after this interval	T _{HD:STA}	SCL, SDA	(See Figure 5)		1.1	-	μs
Hold Time Repeated START Condition	T _{HD:RSTA}	SCL, SDA	(See Figure 5)		0.6	-	μs
Repeated START Condition Setup Time	T _{SU:STA}	SCL, SDA	(See Figure 5)		0.6	-	μs
STOP Condition Setup Time	T _{SU:STO}	SCL, SDA	(See Figure 5)		0.6	-	μs
Data Hold Time	T _{HD:DAT}	SCL, SDA	(See Figure 5)		0	0.9	μs
Data Setup Time	T _{SU:DAT}	SCL, SDA	(See Figure 5)		100	-	ns
Clock Low Period	T _{LOW}	SCL	(See Figure 5)		1.3	-	μs
Clock High Period	T _{HIGH}	SCL	(See Figure 5)		0.6	-	μs
Clock/Data Fall Time	T _F	SCL, SDA			20 + 0.1C _B	300	ns
Clock/Data Rise Time	T _R	SCL, SDA			20 + 0.1C _B	300	ns
Time-out Interval (Notes 4, 5)	T _{TMO}	SCL, SDA	(See Figure 6)		9	11	s
Wake Up Time from Sleep Mode	T _{WU}	SDA	(See Figure 7)		-	400	μs
SDA Low Pulse Width to Wake Up	T _{SP}	SDA	(See Figure 7)		0.6	-	μs
Wake Up Retention Time from the Falling Edge of SDA	T _{WR1}	SDA	(See Figure 7)		500	-	ms
Wake Up Retention Time from STOP Condition	T _{WR2}	SCL, SDA	(See Figure 7)		500	-	ms

- This LSI resets I²C communication if the communication takes more than T_{TMO}. It initializes an internal timer to measure the interval when it detects ninth clock pulse. It can receive a new START condition after the reset.
- This LSI may lose I²C communication at this reset operation. Then if a master can't receive a response it must restart transaction from START condition.

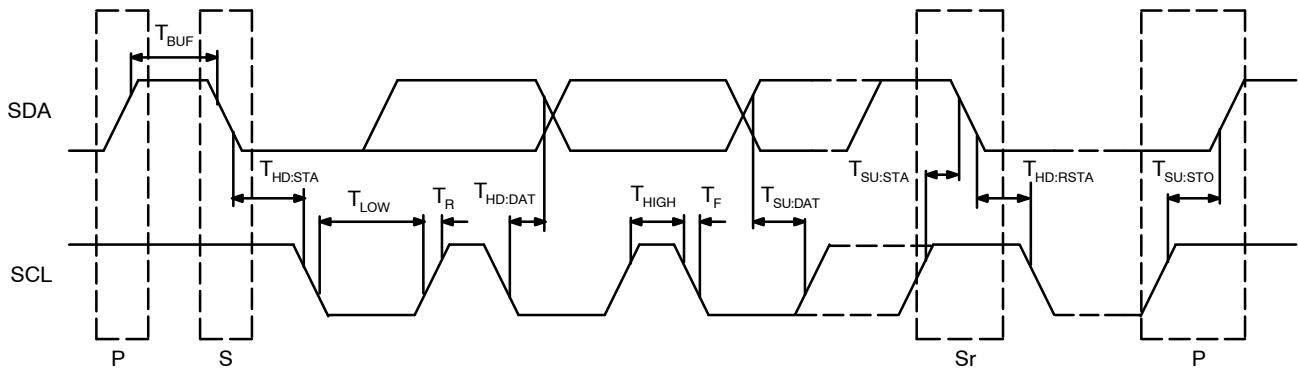

Figure 5. I²C Timing Diagram

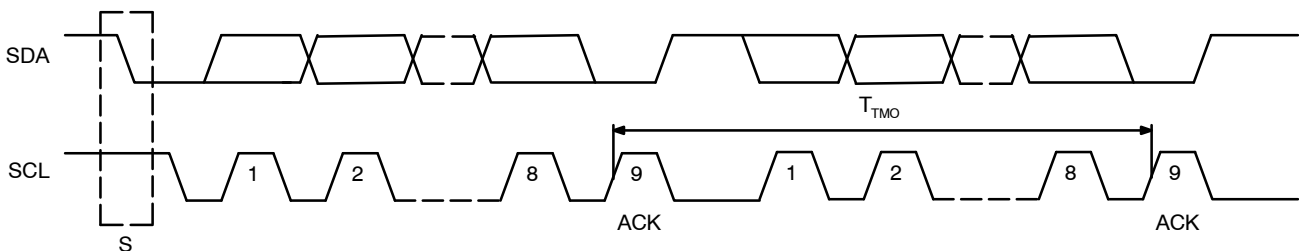

Figure 6. I²C Time-out Interval

I²C Communication Protocol

Communication protocol type: I²C

Frequency: Supported up to 400 kHz

Slave Address: 0001011 (The first 8-bits after the Strat Condition is 0x16 (WRITE) or 0x17 (READ).)

This LSI will stretch the clock.

Bus Protocols

S	:	Start Condition
Sr	:	Repeated Start Condition
Rd	:	Read (bit value of 1)
Wr	:	Write (bit value of 0)
A	:	ACK (bit value of 0)
N	:	NACK (bit value of 1)
P	:	Stop Condition
CRC-8	:	Slave Address to Last Data (CRC-8-ATM : ex.3778 mV : 0x16, 0x09, 0x17, 0xC2, 0x0E → 0x86)
<div style="border: 1px solid black; width: 40px; height: 15px; display: inline-block;"></div>	:	Master-to-Slave
<div style="border: 1px solid black; width: 40px; height: 15px; background-color: #cccccc; display: inline-block;"></div>	:	Slave-to-Master
...	:	Continuation of protocol

Read Word Protocol

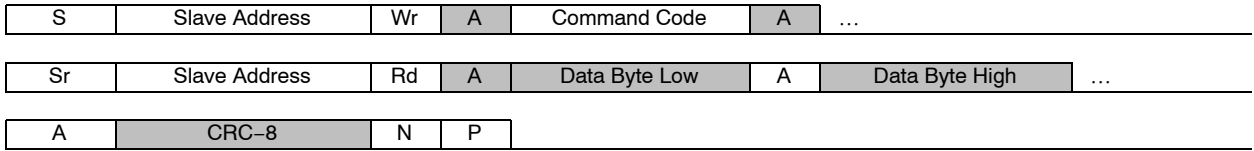

* When you do not read CRC-8, LSI data is not reliable. CRC-8-ATM ex: (5 bytes) 0x16, 0x09, 0x17, 0xC2, 0x0E → 0x86

Write Word Protocol

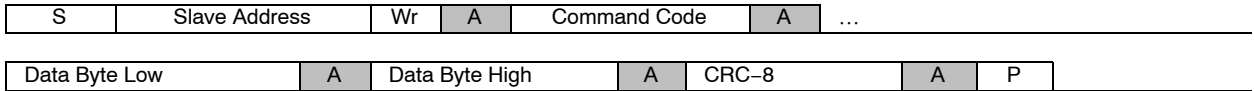

* When you do not add CRC-8, the Written data (Data byte Low/High) become invalid.
CRC-8-ATM ex: (4 bytes) 0x16, 0x09, 0x55, 0xAA → 0x3B

Wake Up from Sleep Mode

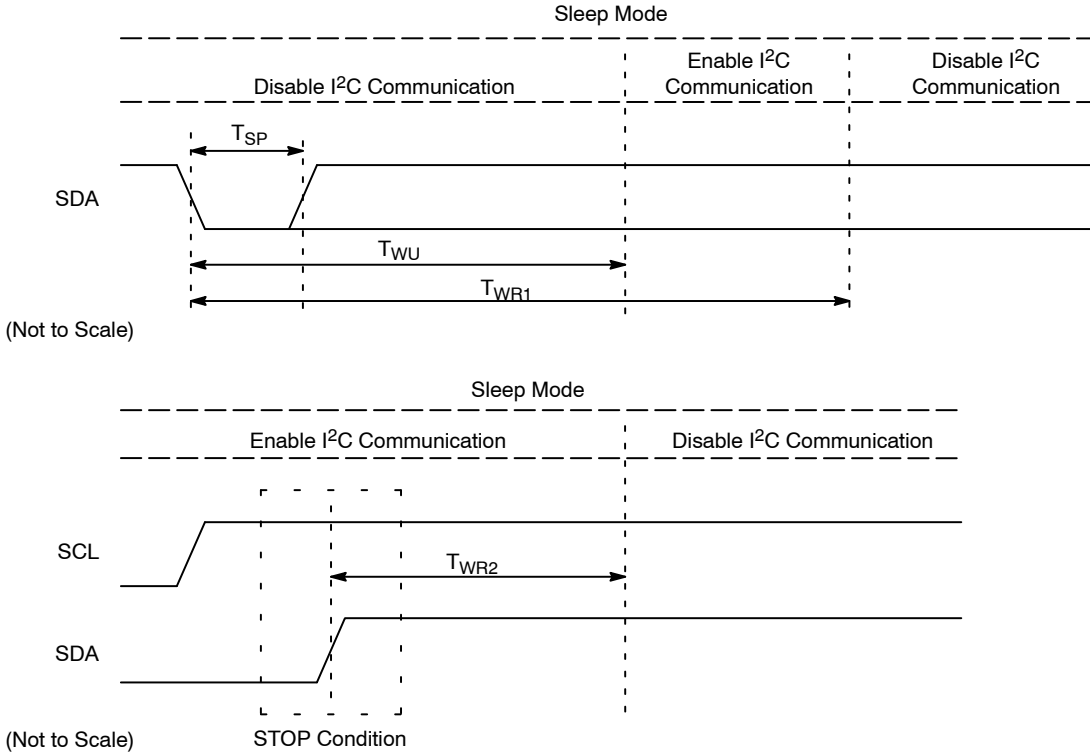

Figure 7. I²C Wake up Timing Diagram

To wake up from Sleep mode, and to start I²C communication, Host side must set SDA low prior to the I²C communication. The Fuel Gauge LSI enables I²C communication after the TWU time period which is measured from the falling edge of SDA, as above timing chart. This “Wake up condition” is invalid for the following two cases:

1. After TWR1 timing following the falling edge of SDA, the Fuel Gauge LSI “Wake up condition” goes into autonomous disable. Once I²C communication is started, the operation doesn’t go into disable until the TWR2 timing has elapsed after STOP condition (below case).
2. After TWR2 timing following I²C Bus STOP condition, the Fuel gauge LSI “Wake up condition” goes into autonomous disable.

If the “Wake up condition” goes into disable, set SDA low to once again wake up from the Sleep mode prior to the I²C communication. If Operational mode is set, it is possible to start I²C communication without this “Wake up operation”.

Notice for I²C Communication Shared with Another Device

When the I²C Bus™ (on which the Fuel Gauge LSI is connected) is shared with another device the Fuel Gauge LSI must be in its operation mode before the other Device starts I²C communication.

Table 6. FUNCTION OF REGISTERS

Command Code	Register Name	R/W	Range	Unit	Description	Initial Value
0x04	Before RSOC	W	0xAA55: Initialize RSOC		Executes RSOC initialization with sampled maximum voltage when 0xAA55 is set.	-
0x06	Thermistor B	R/W	0x0000 to 0xFFFF	1K	Sets B-constant of the thermistor to be measured.	0x0D34
0x07	Initial RSOC	W	0xAA55: Initialize RSOC		Executes RSOC initialization when 0xAA55 is set.	-
0x08	Cell Temperature	R	0x0000 to 0xFFFF	0.1K (0.0°C = 0x0AAC)	Displays Cell Temperature	0x0BA6 (25°C)
		W	0x09E4 to 0x0D04 (I ² C mode)		Sets Cell Temperature in I ² C mode	
0x09	Cell Voltage	R	0x0000 to 0xFFFF	1 mV	Displays Cell Voltage	-
0x0A	Current Direction	R/W	0x0000: Auto mode 0x0001: Charge mode 0xFFFF: Discharge mode		Selects Auto/Charge/Discharge mode	0x0000
0x0B	APA (Adjustment Pack Application)	R/W	0x0000 to 0x00FF		Sets Adjustment parameter	-
0x0C	APT (Adjustment Pack Thermistor)	R/W	0x0000 to 0xFFFF		Sets a value to adjust temperature measurement delay timing	0x001E
0x0D	RSOC	R/W	0x0000 to 0x0064	1%	Displays RSOC value based on a 0-100 scale	-
0x0F	ITE (Indicator to Empty)	R	0x0000 to 0x03E8	0.1%	Displays RSOC value based on a 0-1000 scale	-
0x11	IC Version	R	0x0000 to 0xFFFF		Displays an ID number of an IC	-
0x12	Change Of The Parameter	R/W	0x0000 or 0x0001		Selects a battery profile	0x0000
0x13	Alarm Low RSOC	R/W	0x0000: Disable 0x0001 to 0x0064: Threshold	1%	Sets RSOC threshold to generate Alarm signal	0x0008
0x14	Alarm Low Cell Voltage	R/W	0x0000: Disable 0x0001 to 0xFFFF: Threshold	1 mV	Sets Voltage threshold to generate Alarm signal	0x0000
0x15	IC Power Mode	R/W	0x0001: Operational mode 0x0002: Sleep mode		Selects Power mode	(Note 6)
0x16	Status Bit	R/W	0x0000: I ² C mode 0x0001: Thermistor mode		Selects Temperature obtaining method	0x0000
0x1A	Number of The Parameter	R	0x0301 or 0x0504		Displays Battery profile code	-

NOTE: 0xXXXX = Hexadecimal notation

6. See "Power-on Reset/Battery Insertion Detection" and Figure 17.

Before RSOC (0x04)

This LSI will get initial RSOC by Open Circuit Voltage (OCV) of a battery. It is desirable for battery current to be less than 0.025C to get expected OCV. (i.e. less than 75 mA for 3000 mAh design capacity battery.) This LSI initializes RSOC by measured battery voltage in initial sequence. (See Figure 8) But if reported RSOC after reset release is not expected value, "Before RSOC" command (0x04 = AA55) or "Initial RSOC" command (0x07 = AA55) can initialize RSOC again.

"Before RSOC" command can obtain historical voltage data in-between Release reset and "Before RSOC" command timing. And this command initializes RSOC with the maximum battery voltage which was obtained. (See Figure 9) Don't use this command if battery is charged in the term.

Thermistor B (0x06)

Sets B-constant of the thermistor to be measured. Refer to the specification sheet of the thermistor for the set value to use.

Initial RSOC (0x07)

The LSI can be forced to initialize RSOC by sending the Before RSOC Command (0x04 = AA55) or the Initial RSOC Command (0x07 = AA55).

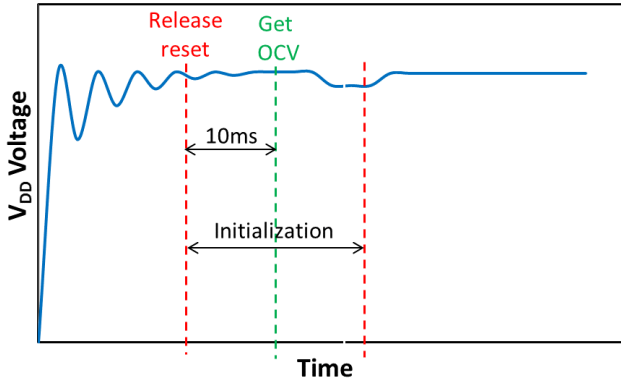

Figure 8. RSOC Automatic Initialization

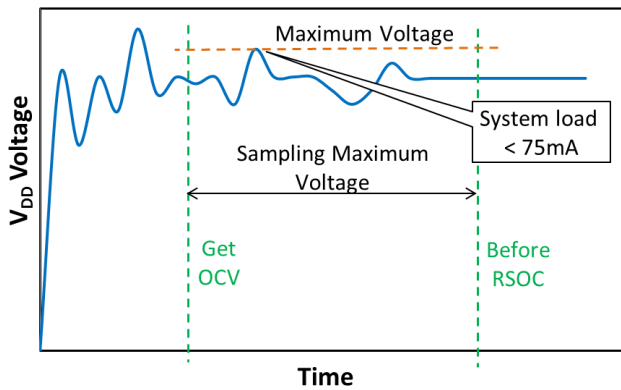

Figure 9. Before RSOC Command

The LSI initializes RSOC by the measured voltage at that time when the Initial RSOC command is written. (See Figure 10). The maximum time to initialize RSOC after the command is written is 1.5 ms.

Cell Temperature (0x08)

This register contains the cell temperature from -20°C (0x09E4) to $+60^{\circ}\text{C}$ (0x0D04) measured in 0.1°C units.

In the Thermistor mode (0x16 = 01) the LSI measures the attached thermistor and loads the temperature into the Cell Temperature register. In the Thermistor mode, the thermistor shall be connected to the LSI as shown in Figure 2. The temperature is measured by having TSW pin to provide power into the thermistor and TSENSE pin to sense the output voltage from the thermistor. Temperature measurement timing is controlled by the LSI, and the power to the thermistor is not supplied for other reasons except to measure the temperature.

In the I²C mode (0x16 = 00) the temperature is provided by the host processor. During discharge/charge the register should be updates when the temperature changes more than 1°C

Cell Voltage (0x09)

This register contains the voltage on V_{DD} 1 mV units.

Current Direction (0x0A)

This register is used to control the reporting of RSOC. In Auto mode the RSOC is reported as it increases or decreases. In Charge mode the RSOC is not permitted to decrease. In Discharge mode the RSOC is not permitted to increase.

With consideration of capacity influence by temperature, we recommend operating in Auto because RSOC is affected by the cell temperature. A warm cell has more capacity than a cold cell. Be sure not to charge in the Discharge mode and discharge in the Charge mode; it will create an error.

An example of RSOC reporting is shown in Figures 11 and 12.

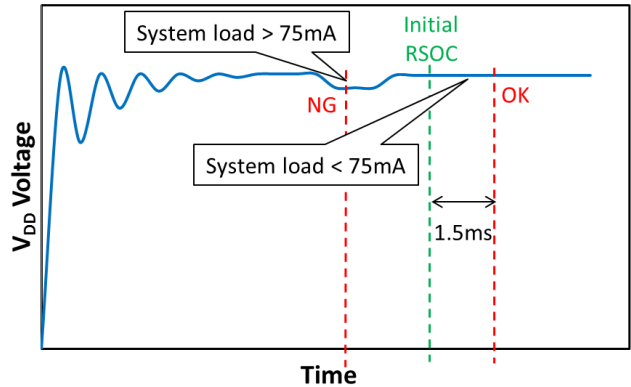

Figure 10. Initial RSOC Command

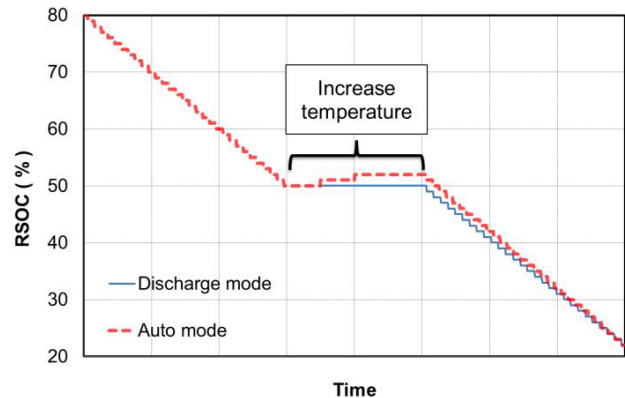

Figure 11. Discharge Mode
(An example with increasing in temperature. A warm cell has more capacity than a cold cell. Therefore RSOC increases without charging in Auto mode)

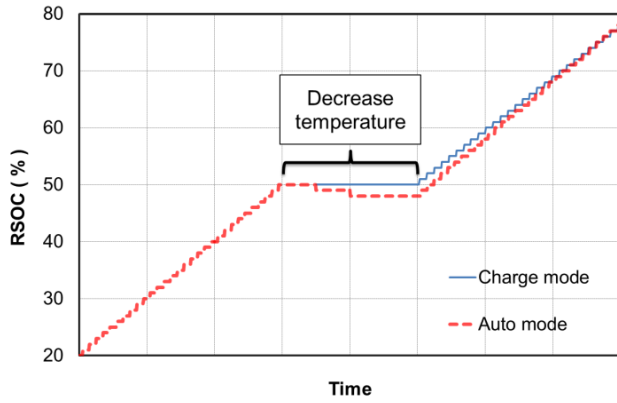

Figure 12. Charge Mode
 (An example with decreasing in temperature. A cold cell has less capacity than a warm cell. Therefore RSOC decreases without discharging in Auto mode)

Adjustment Pack Application (0x0B)

This register contains the adjustment value for a battery type to improve the RSOC precision. Figure 13 and Table 7 show typical values of APA according to the design capacities per 1 cell and battery type. When some batteries are connected in parallel, the design capacity per 1 cell is applied to the table. The APA values of Type-04 and Type-05 are used for battery type that is specified in Table 8. Please contact ON Semiconductor if you don't satisfy the RSOC precision. The deeper adjustment of APA may improve the accuracy.

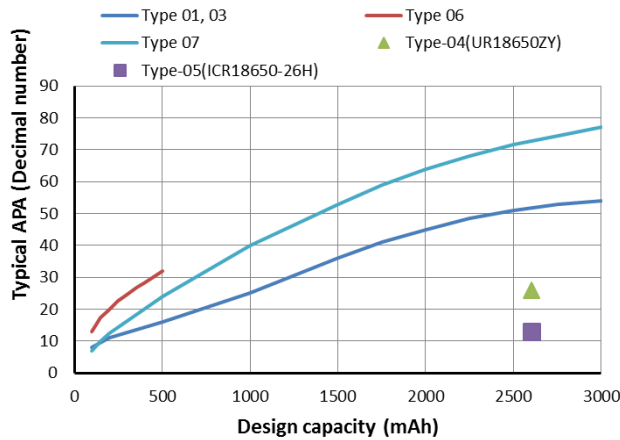

Figure 13. Typical APA

Adjustment Pack Thermistor (0x0C)

This is used to compensate for the delay of the thermistor measurement caused by a capacitor across the thermistor. The default value has been found to meet most of circuits where a capacitor like showing in Figure 14 is not put.

Please contact ON Semiconductor if you have an unusual circuit implementation.

Table 7. TYPICAL APA

Design Capacity of Battery	APA(0x0B)		
	Type-01, Type-03	Type-06	Type-07
100 mAh	0x08	0x0D	0x07
200 mAh	0x0B	0x15	0x0C
500 mAh	0x10	0x20	0x18
1000 mAh	0x19	-	0x28
2000 mAh	0x2D	-	0x40
3000 mAh	0x36	-	0x4D

Design Capacity of Battery	APA(0x0B)	
	Type-04	Type-05
2600 mAh	0x1A	0x0D

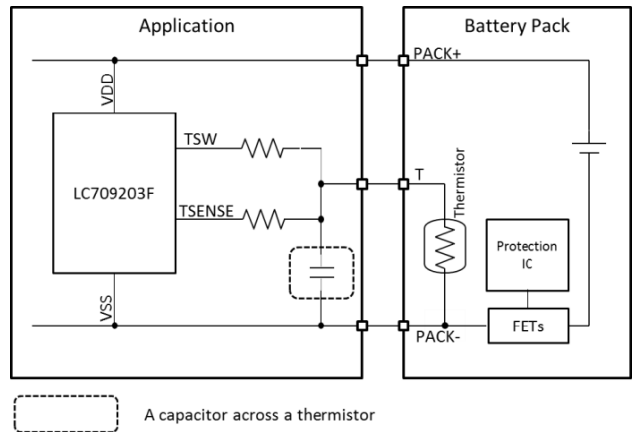

Figure 14. An Example of a Capacitor Across the Thermistor

RSOC (0x0D)

RSOC is reported in 1% units over the range 0% to 100%. When this register is written in operational mode the data may be updated to close it to actual RSOC of a battery. Set Sleep mode to keep the data. Writing to this register is not necessary in normal operation. ITE (0x0F) will be updated with the writing too.

Indicator to Empty (0x0F)

This is the same as RSOC with a resolution of 0.1% over the range 0.0% to 100.0%.

IC Version (0x11)

This is an ID number of an LSI.

Change of the Parameter (0x12)

The LSI contains a data file comprised of two battery profiles. This register is used to select the battery profile to be used. See Table 8. Register Number of the Parameter (0x1A) contains identity of the data file.

The Data file is loaded during final test depending on the part number ordered.

Most of the time, battery nominal/rated voltage or charging voltage values are used to determine which profile data shall be used. Please contact ON Semiconductor if you cannot identify which profile to select.

Alarm Low RSOC (0x13)

The ALARMB pin will be set low when the RSOC value falls below this value, will be released from low when RSOC value rises than this value. Set to Zero to disable. Figure 15.

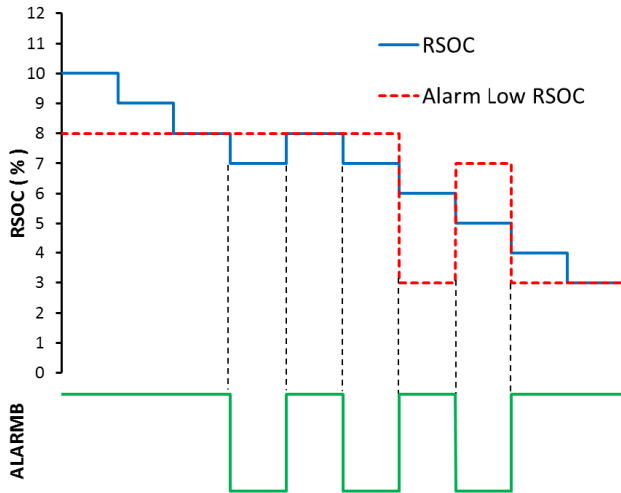

Figure 15. Alarm Low RSOC

Alarm Low Cell Voltage (0x14)

The ALARMB pin will be set low if VDD falls below this value, will be released from low if VDD rises than this value. Set to Zero to disable. Figure 16.

IC Power Mode (0x15)

The LSI has two power modes. Sleep (0x15 = 02) or Operational mode (0x15 = 01). In the Sleep mode only I²C communication functions. In the Operational mode all functions operate with full calculation and tracking of RSOC during charge and discharge.

If the battery is significantly charged or discharged during sleep mode, the RSOC will not be accurate. Moved charge

is counted continuously to measure the RSOC in Operational mode. If battery is discharged or charged in the Sleep mode, the count breaks off.

When it is switched from Sleep mode to Operational mode, RSOC calculation is continued by using the data which was measured in the previous Operational mode.

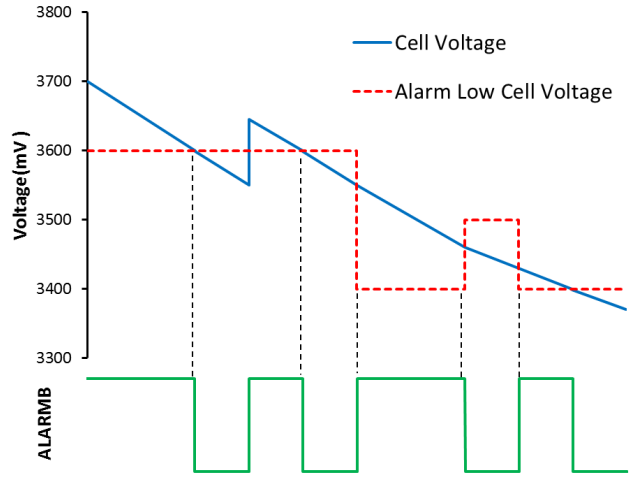

Figure 16. Alarm Low Cell Voltage

Status Bit (0x16)

This selects the Thermistor mode. Thermistor mode (0x16 = 01) the LSI measures the attached thermistor and loads the temperature into the Cell Temperature register.

I²C mode (0x16 = 00) the temperature is provided by the host processor.

Number of the Parameter (0x1A)

The LSI contains a data file comprised of two battery profiles. This register contains identity of the data file. Please see register *Change of the Parameter (0x12)* to select the battery profile to be used. See Table 8.

The Data file is loaded during final test depending on the part number ordered. This file can be loaded in the field if required.

Please contact ON Semiconductor if you cannot identify which profile to select.

Table 8. BATTERY PROFILE VS. REGISTER

IC Type	Battery Type	Nominal/Rated Voltage	Charging Voltage	Design Capacity	Number of the Parameter (0x1A)	Change of the Parameter (0x12)
LC709203Fxx-01xx	03	3.8 V	4.35 V	≥ 500 mAh	0x0301	0x0000
	01	3.7 V	4.2 V	–		0x0001
LC709203Fxx-03xx	06	3.8 V	4.35 V	< 500 mAh	0x0601	0x0000
	01	3.7 V	4.2 V	–		0x0001
LC709203Fxx-04xx	05	ICR18650-26H (SAMSUNG)			0x0504	0x0000
	04	UR18650ZY (Panasonic)				0x0001
LC709203Fxx-05xx	07	3.85 V	4.4 V	–	0x0706	0x0000
	06	3.8 V	4.35 V	< 500 mAh		0x0001

HG-CVR

$$RSOC = \frac{RM}{FCC} \times 100\% \quad (\text{eq. 3})$$

Hybrid Gauging by Current-Voltage Tracking with Internal Resistance

HG-CVR is ON Semiconductor’s unique method which is used to calculate accurate RSOC. **HG-CVR** first measures battery voltage and temperature. Precise reference voltage is essential for accurate voltage measurement. LC709203F has accurate internal reference voltage circuit with little temperature dependency.

It also uses the measured battery voltage and internal impedance and Open Circuit Voltage (OCV) of a battery for the current measurement. OCV is battery voltage without load current. The measured battery voltage is separated into OCV and varied voltage by load current. The varied voltage is the product of load current and internal impedance. Then the current is determined by the following formulas.

$$V(\text{VARIED}) = V(\text{MEASURED}) - \text{OCV} \quad (\text{eq. 1})$$

$$I = \frac{V(\text{VARIED})}{R(\text{INTERNAL})} \quad (\text{eq. 2})$$

Where $V(\text{VARIED})$ is varied voltage by load current, $V(\text{MEASURED})$ is measured voltage, $R(\text{INTERNAL})$ is internal impedance of a battery. Detailed information about the internal impedance and OCV is installed in the LSI. The internal impedance is affected by remaining capacity, load-current, temperature, and more. Then the LSI has the information as look up table. **HG-CVR** accumulates battery coulomb using the information of the current and a steady period by a high accuracy internal timer. The remaining capacity of a battery is calculated with the accumulated coulomb.

How to Identify Aging

By repeating discharge/charge, internal impedance of a battery will gradually increase, and the Full Charge Capacity (FCC) will decrease. In coulomb counting method RSOC is generally calculated using the FCC and the Remaining Capacity (RM).

Then the decreased FCC must be preliminarily measured with learning cycle. But **HG-CVR** can measure the RSOC of deteriorated battery without learning cycle. The internal battery impedance that **HG-CVR** uses to calculate the current correlates highly with FCC. The correlation is based on battery chemistry. The RSOC that this LSI reports using the correlation is not affected by aging.

Figures 24–26 show RSOC measurement result of a battery with decreased FCC due to its aging. The shown RSOC is based on the decreased FCC even with a battery with 80% FCC after executing 300 times of discharge/charge.

Automatic Convergence of the Error

A problem of coulomb counting method is the fact that the error is accumulated over time – This error must be corrected. The general gauges using coulomb counting method must find an opportunity to correct it.

This LSI with **HG-CVR** has the feature that the error of RSOC converges autonomously, and doesn’t require calibration opportunities. The error constantly converges in the value estimated from the Open Circuit Voltage. Figure 27 shows the convergent characteristic example from the initialize error.

Also, coulomb counting method cannot detect accurate residual change because the amount of the current from self-discharge is too small but **HG-CVR** is capable to deal with such detection by using the voltage information.

Simple and Quick Setup

In general, it is necessary to obtain multiple parameters for a fuel gauge and it takes a lot of resource and additional development time of the users. One of the unique features of LC709203F is very small number of parameters to be prepared by the beginning of battery measurement – the minimum amount of parameter which users may make is one because Adjustment pack application register has to

have one. Such simple and quick start-up is realized by having multiple profile data in the LSI to support various types of batteries. Please contact your local sales office to learn more information on how to measure a battery that cannot use already-prepared profile data.

Low Power Consumption

Low power consumption of 3 μ A is realized in the Operation mode. This LSI monitors charge/discharge condition of a battery and changes the sampling rate according to its change of current. Power consumption reduction without deteriorating its RSOC accuracy was enabled by utilizing this method.

Power-on Reset/Battery Insertion Detection

When this LSI detects battery insertion, it starts Power-on reset automatically. Once the battery voltage exceeds over the V_{RR} , it will release RESET status and will complete LSI initialization within T_{INT} to enter into Operational mode. All registers are initialized after Power-on reset. Then I²C communication can be started.

LC709203FXE-0xMH sets itself into Sleep mode automatically after T_{ATS} from the end of initialization. Therefore set to operational mode manually after it enters

into Sleep mode. LC709203FQH-0xTWG doesn't set itself into Sleep mode automatically. Figure 17.

This LSI will also execute system reset automatically if a battery voltage exceeds under the V_{RR} during operation. Furthermore after Change of the Parameter (0x12) command input it will execute LSI initialization like battery insertion. Figure 18.

Parasitic Resistance

The LSI measures RSOC by using internal impedance of a battery. Therefore, the parasitic resistance which exists in V_{DD}/V_{SS} Lines between measured Battery or Battery Pack to the LSI can become an error factor. But the resistance of Lines which is not connected other than the LSI is not included. Figure 19.

The lower resistance may improve the RSOC precision. Please see LC709203F Application note for information about layout method of V_{DD}/V_{SS} Lines to reduce it.

Measurement Starting Flow

After Reset release, users can start battery measurement by writing appropriate value into the registers by following the flow shown in Figures 20–21. Please refer to Register function section for more information about each register.

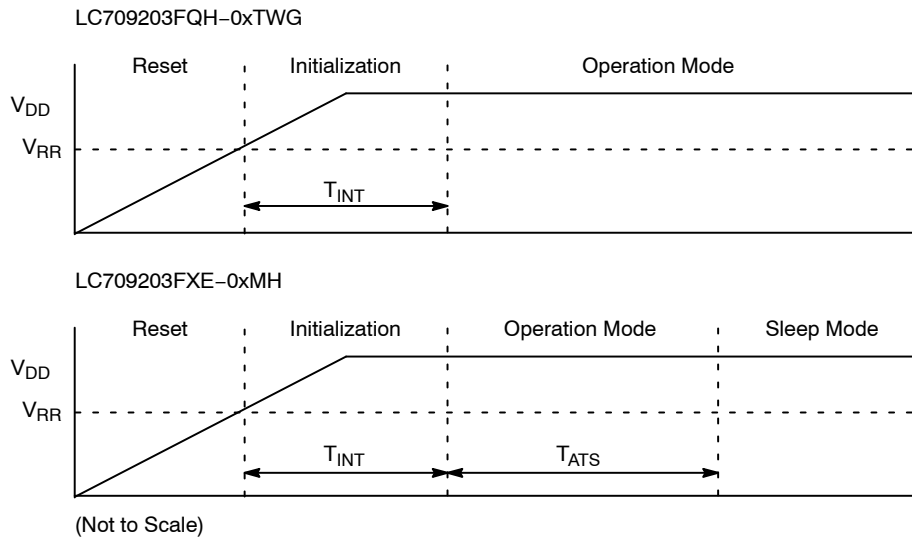

Figure 17. Power On Timing Diagram

LC709203F

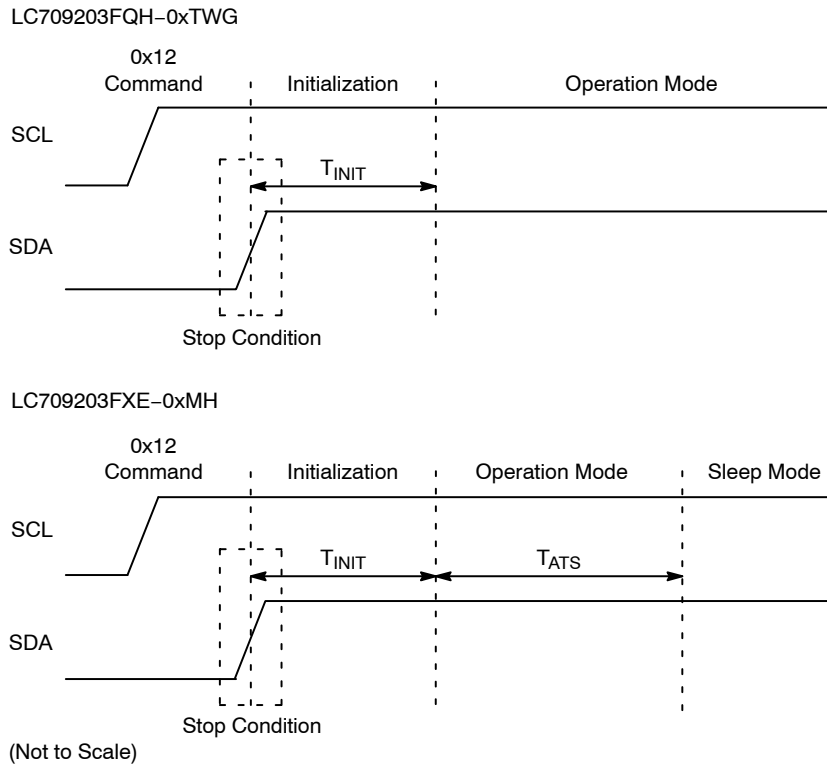

Figure 18. Timing Diagram after 0x12 Command

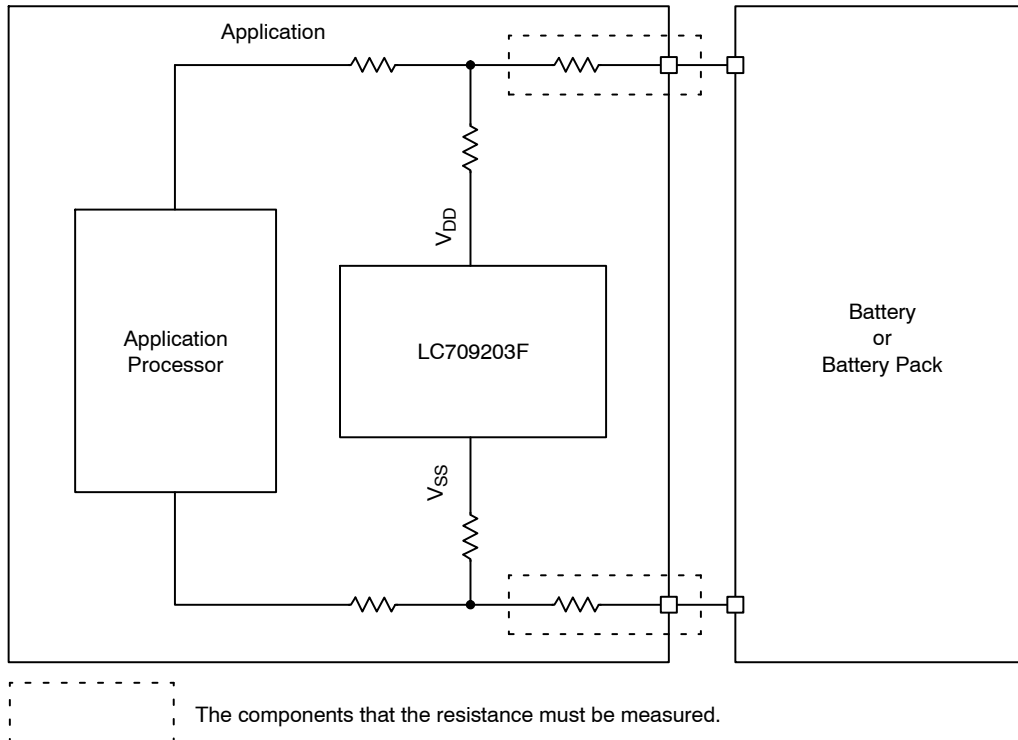

Figure 19. An Example of Parasitic Resistance

STARTING FLOW

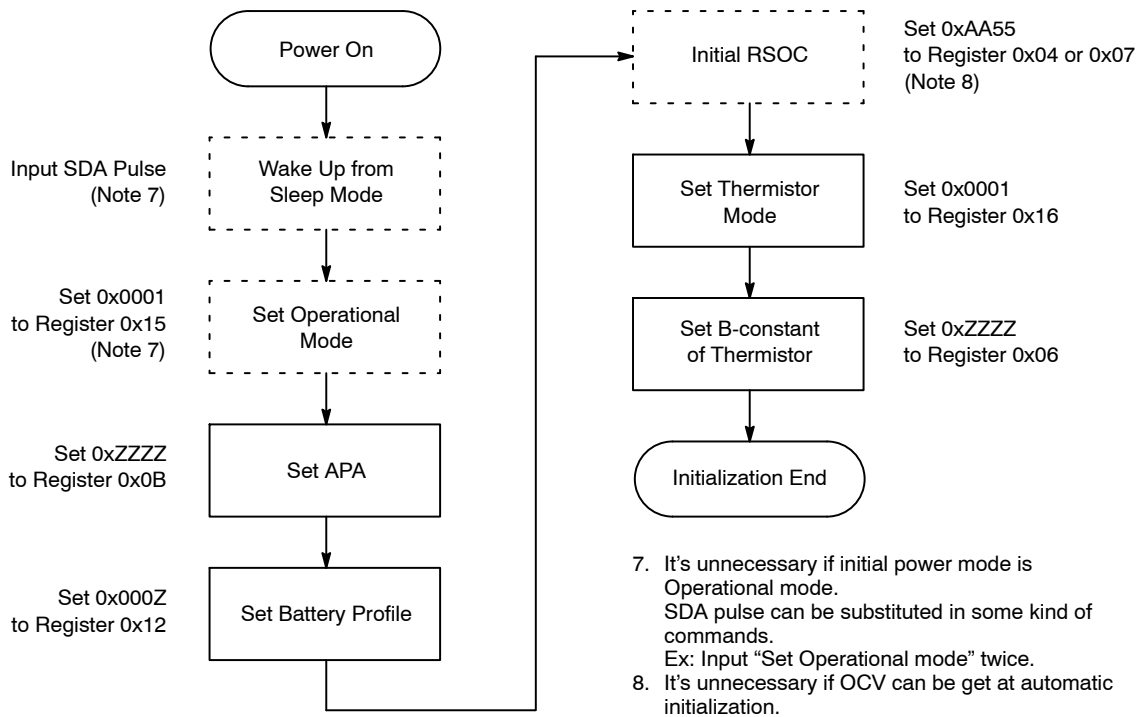

Figure 20. Starting Flow at Thermistor Mode

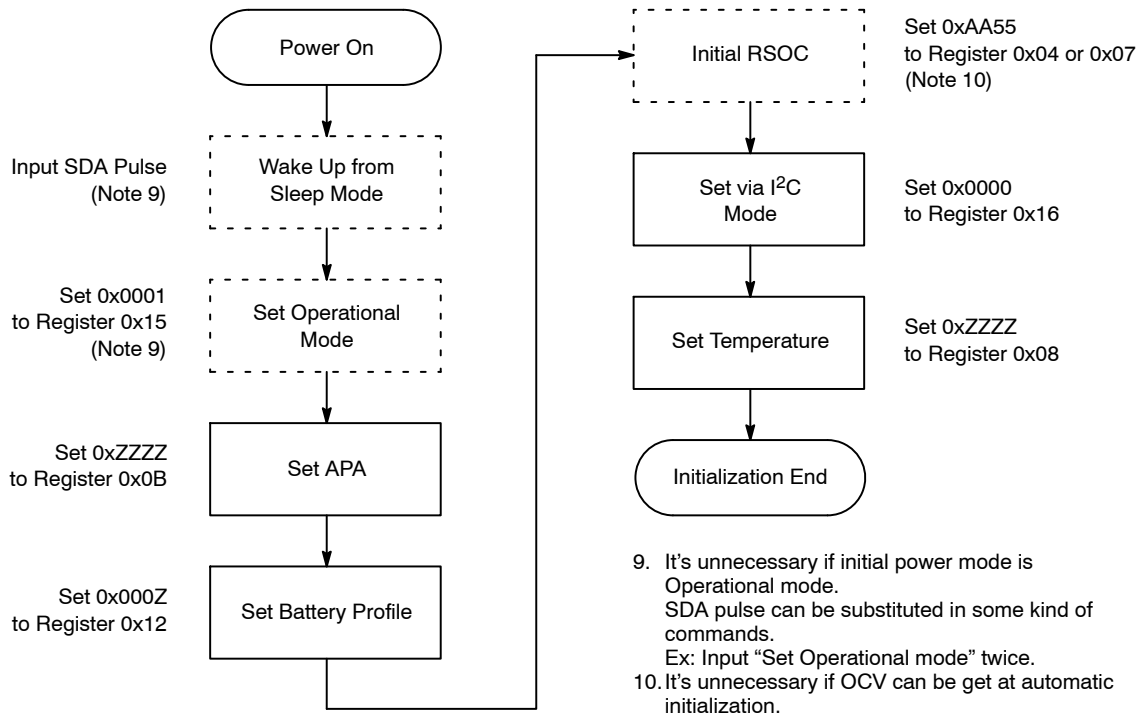

Figure 21. Starting Flow at I²C Mode

LC709203F

TYPICAL CHARACTERISTICS

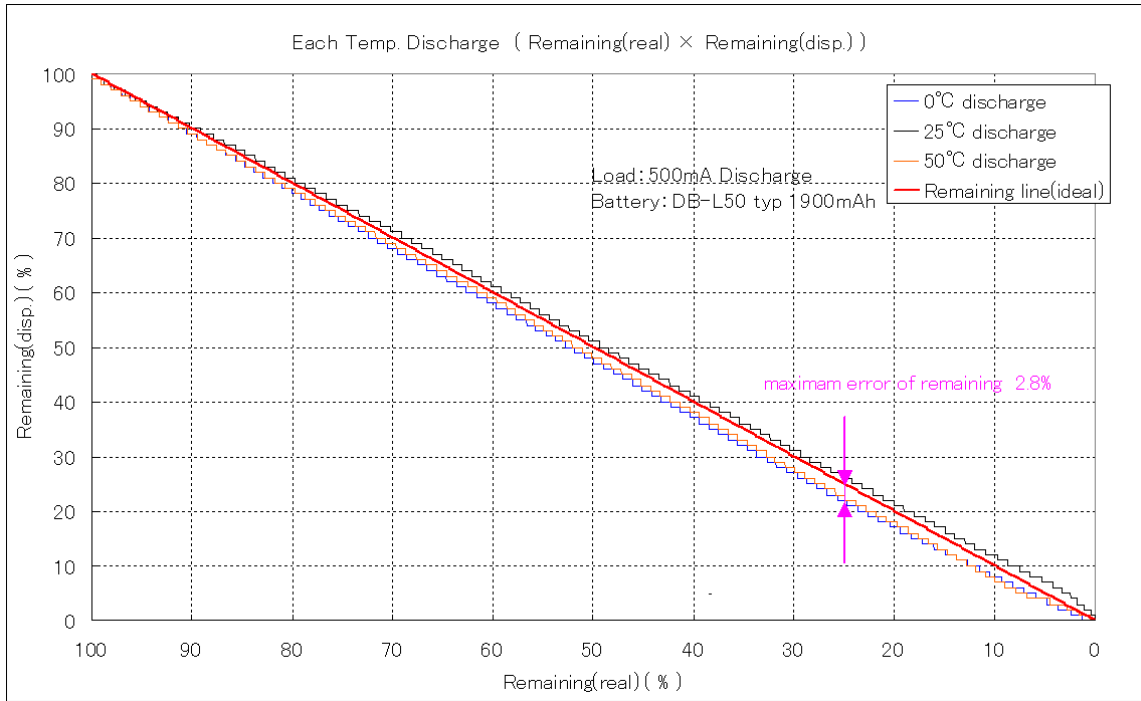

Figure 22. Discharge Characteristics by Temperature Change

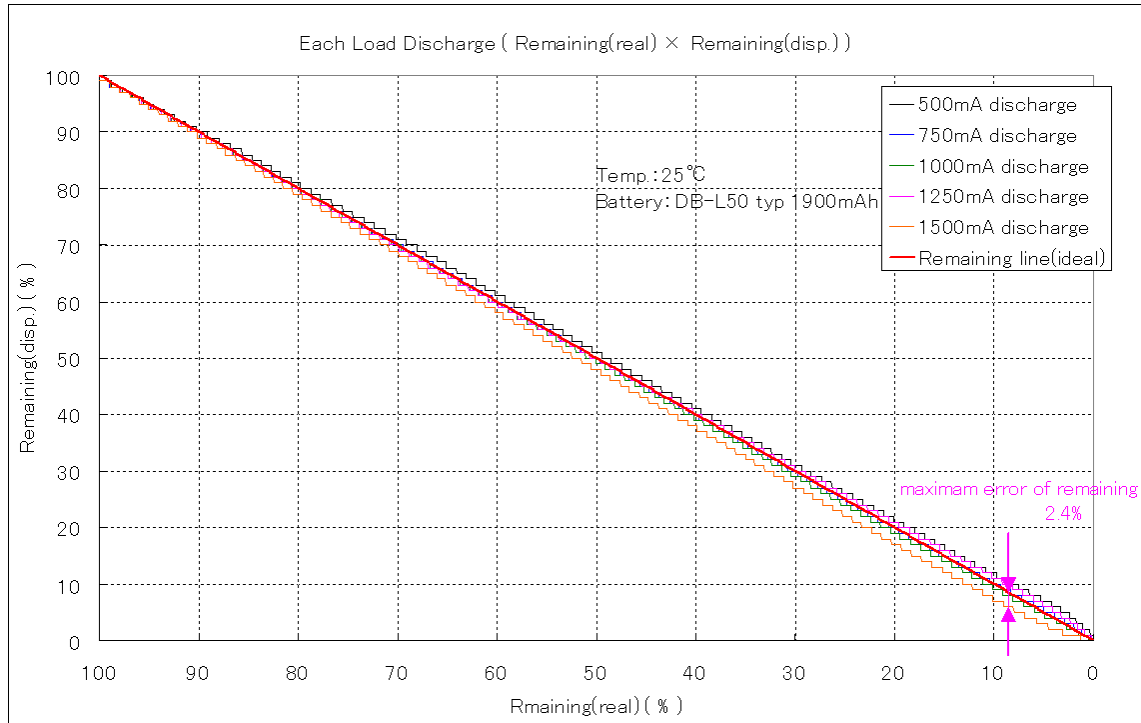

Figure 23. Discharge Characteristics by Load Change

TYPICAL CHARACTERISTICS

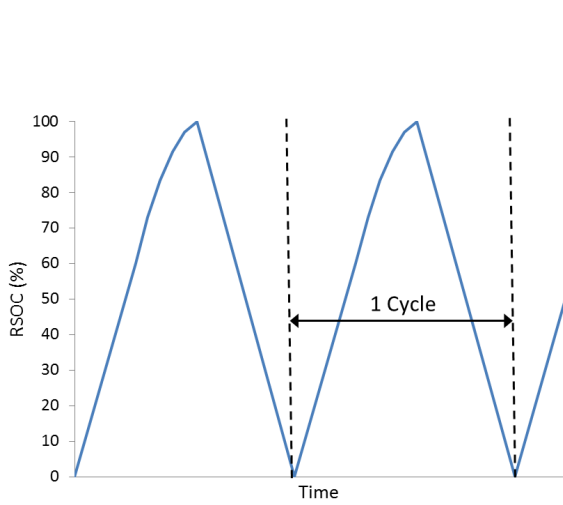

Figure 24. Discharge/Charge Cycle

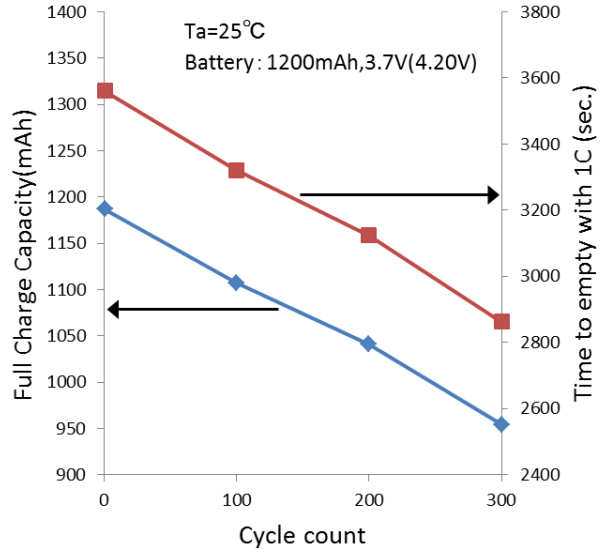

Figure 25. Battery Capacity Deterioration

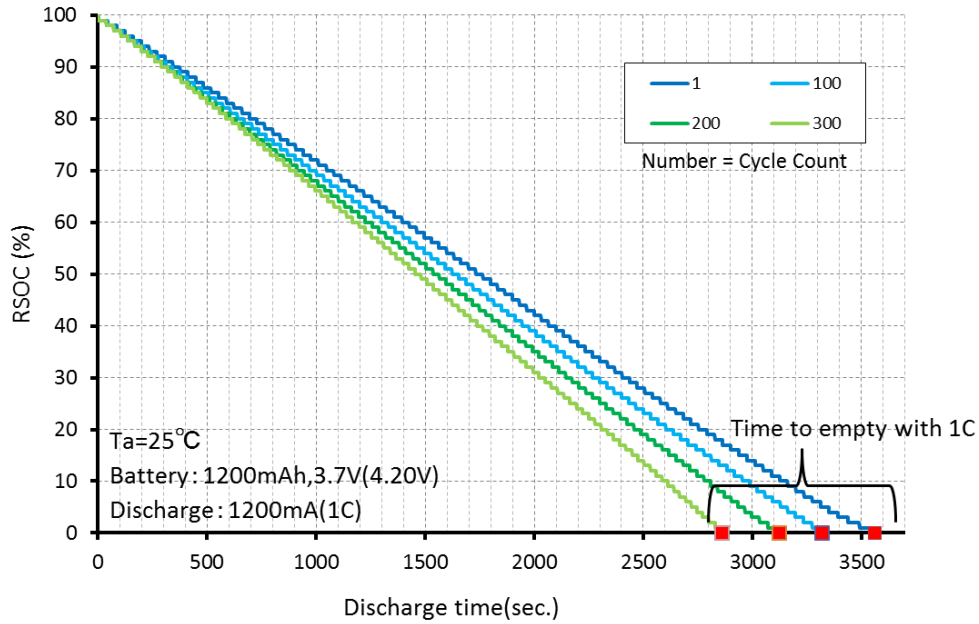

Figure 26. Discharge Characteristics of Deterioration Battery

LC709203F

TYPICAL CHARACTERISTICS

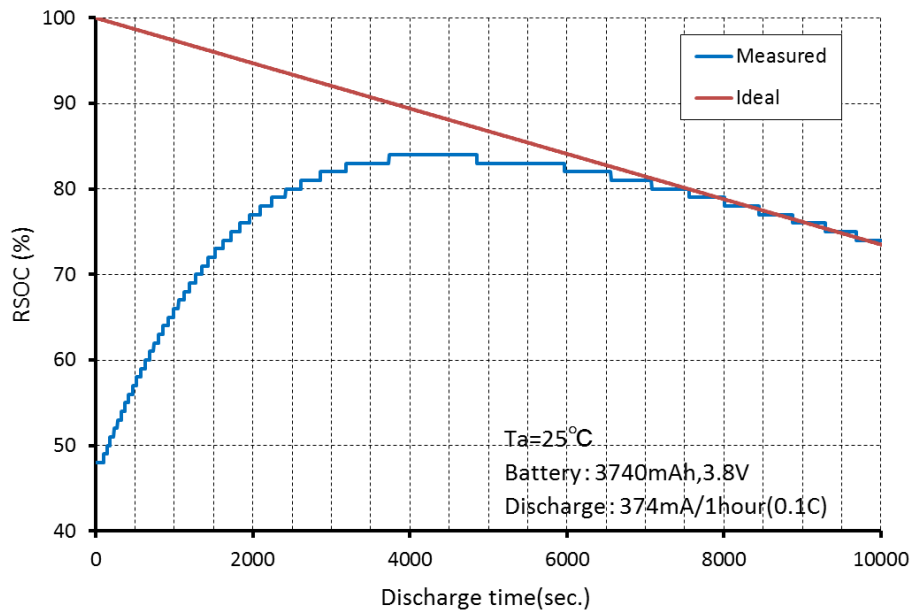

Figure 27. Convergent Characteristic from the Initialize Error
This Graph is the Example for Starting Point 48% (Includes 52% Error Case) Instead of 100% (No Error)

Table 9. ORDERING INFORMATION

Device	Package	Shipping [†]
LC709203FQH-01TWG	WDFN8 3x4, 0.65P (Pb-Free / Halogen Free)	2,000 / Tape & Reel
LC709203FQH-02TWG	WDFN8 3x4, 0.65P (Pb-Free / Halogen Free)	2,000 / Tape & Reel
LC709203FQH-03TWG	WDFN8 3x4, 0.65P (Pb-Free / Halogen Free)	2,000 / Tape & Reel
LC709203FQH-04TWG	WDFN8 3x4, 0.65P (Pb-Free / Halogen Free)	2,000 / Tape & Reel
LC709203FXE-01MH	WLCSP9, 1.60x1.76 (Pb-Free / Halogen Free)	5,000 / Tape & Reel
LC709203FXE-02MH	WLCSP9, 1.60x1.76 (Pb-Free / Halogen Free)	5,000 / Tape & Reel
LC709203FXE-03MH	WLCSP9, 1.60x1.76 (Pb-Free / Halogen Free)	5,000 / Tape & Reel
LC709203FXE-04MH	WLCSP9, 1.60x1.76 (Pb-Free / Halogen Free)	5,000 / Tape & Reel
LC709203FXE-05MH	WLCSP9, 1.60x1.76 (Pb-Free / Halogen Free)	5,000 / Tape & Reel

[†]For information on tape and reel specifications, including part orientation and tape sizes, please refer to our Tape and Reel Packaging Specifications Brochure, [BRD8011/D](#).

NOTE: IC performance may vary depend on the types of battery to be in use. Contact your local sales office for assistance in choosing the correct model.

ON Semiconductor is licensed by the Philips Corporation to carry the I²C bus protocol. All other brand names and product names appearing in this document are registered trademarks or trademarks of their respective holders.

MECHANICAL CASE OUTLINE

PACKAGE DIMENSIONS

ON Semiconductor®

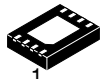

SCALE 2:1

WDFN8 3x4, 0.65P
CASE 509AF
ISSUE C

DATE 06 MAY 2014

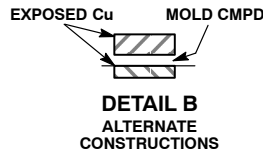
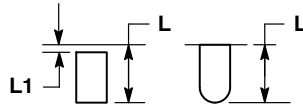
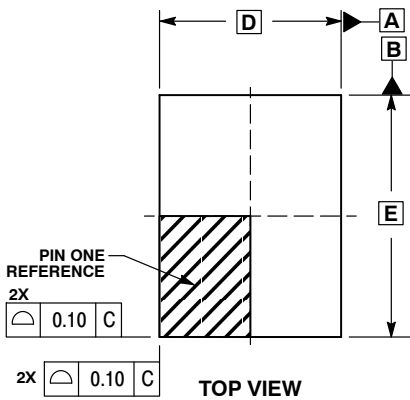

NOTES:

1. DIMENSIONING AND TOLERANCING PER ASME Y14.5M, 1994.
2. CONTROLLING DIMENSION: MILLIMETERS.
3. DIMENSION b APPLIES TO PLATED TERMINAL AND IS MEASURED BETWEEN 0.15 AND 0.30mm FROM THE TERMINAL TIP.
4. PROFILE TOLERANCE APPLIES TO THE EXPOSED PAD AS WELL AS THE LEADS.

DIM	MILLIMETERS	
	MIN	MAX
A	---	0.80
A1	0.00	0.05
A3	0.20	REF
b	0.20	0.30
D	3.00	BSC
D2	1.70	1.90
E	4.00	BSC
E2	2.30	2.50
e	0.65	BSC
L	0.45	0.55
L1	---	0.10

GENERIC MARKING DIAGRAM*

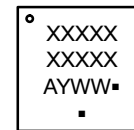

- A = Assembly Location
- Y = Year
- WW = Work Week
- = Pb-Free Package

(Note: Microdot may be in either location)

*This information is generic. Please refer to device data sheet for actual part marking. Pb-Free indicator, "G" or microdot "▪", may or may not be present.

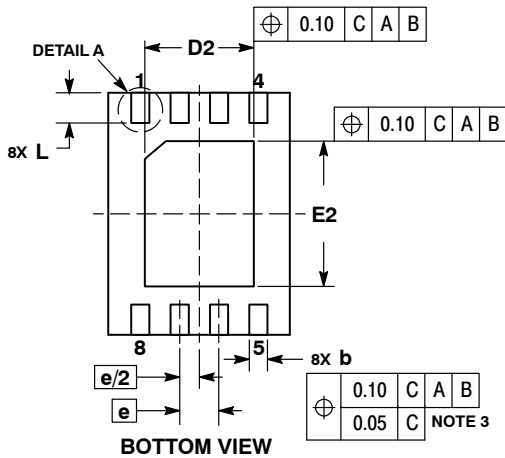
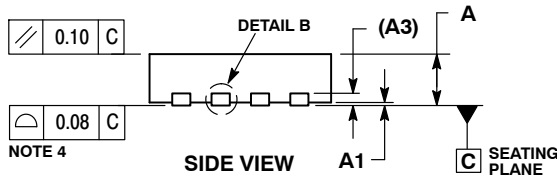

RECOMMENDED SOLDERING FOOTPRINT*

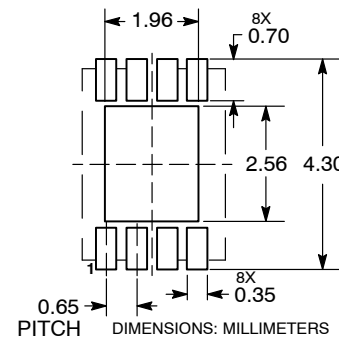

*For additional information on our Pb-Free strategy and soldering details, please download the ON Semiconductor Soldering and Mounting Techniques Reference Manual, SOLDERRM/D.

DOCUMENT NUMBER:	98AON80983E	Electronic versions are uncontrolled except when accessed directly from the Document Repository. Printed versions are uncontrolled except when stamped "CONTROLLED COPY" in red.
DESCRIPTION:	WDFN8 3X4, 0.65P	PAGE 1 OF 1

ON Semiconductor and ON are trademarks of Semiconductor Components Industries, LLC dba ON Semiconductor or its subsidiaries in the United States and/or other countries. ON Semiconductor reserves the right to make changes without further notice to any products herein. ON Semiconductor makes no warranty, representation or guarantee regarding the suitability of its products for any particular purpose, nor does ON Semiconductor assume any liability arising out of the application or use of any product or circuit, and specifically disclaims any and all liability, including without limitation special, consequential or incidental damages. ON Semiconductor does not convey any license under its patent rights nor the rights of others.

MECHANICAL CASE OUTLINE

PACKAGE DIMENSIONS

ON Semiconductor®



SCALE 4:1

WLCSP9, 1.60x1.76
CASE 567JH
ISSUE B

DATE 23 JAN 2014

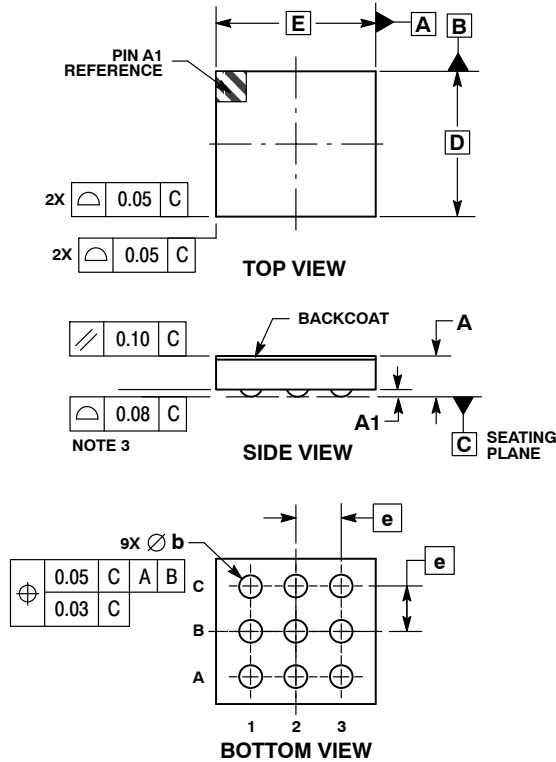

- NOTES:
1. DIMENSIONING AND TOLERANCING PER ASME Y14.5M, 1994.
 2. CONTROLLING DIMENSION: MILLIMETERS.
 3. COPLANARITY APPLIES TO THE SPHERICAL CROWNS OF THE SOLDER BALLS.

DIM	MILLIMETERS	
	MIN	MAX
A	---	0.51
A1	0.09	0.19
b	0.20	0.30
D	1.60 BSC	
E	1.76 BSC	
e	0.50 BSC	

RECOMMENDED SOLDERING FOOTPRINT*

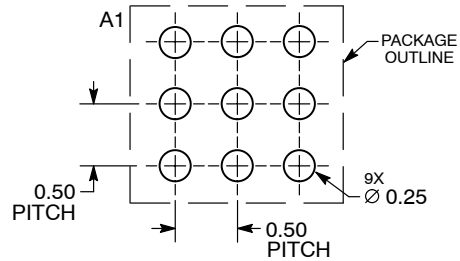

DIMENSIONS: MILLIMETERS

*For additional information on our Pb-Free strategy and soldering details, please download the ON Semiconductor Soldering and Mounting Techniques Reference Manual, SOLDERRM/D.

DOCUMENT NUMBER:	98AON79525F	Electronic versions are uncontrolled except when accessed directly from the Document Repository. Printed versions are uncontrolled except when stamped "CONTROLLED COPY" in red.
DESCRIPTION:	WLCSP9, 1.60X1.76	PAGE 1 OF 1

ON Semiconductor and are trademarks of Semiconductor Components Industries, LLC dba ON Semiconductor or its subsidiaries in the United States and/or other countries. ON Semiconductor reserves the right to make changes without further notice to any products herein. ON Semiconductor makes no warranty, representation or guarantee regarding the suitability of its products for any particular purpose, nor does ON Semiconductor assume any liability arising out of the application or use of any product or circuit, and specifically disclaims any and all liability, including without limitation special, consequential or incidental damages. ON Semiconductor does not convey any license under its patent rights nor the rights of others.

ON Semiconductor and  are trademarks of Semiconductor Components Industries, LLC dba ON Semiconductor or its subsidiaries in the United States and/or other countries. ON Semiconductor owns the rights to a number of patents, trademarks, copyrights, trade secrets, and other intellectual property. A listing of ON Semiconductor's product/patent coverage may be accessed at www.onsemi.com/site/pdf/Patent-Marking.pdf. ON Semiconductor reserves the right to make changes without further notice to any products herein. ON Semiconductor makes no warranty, representation or guarantee regarding the suitability of its products for any particular purpose, nor does ON Semiconductor assume any liability arising out of the application or use of any product or circuit, and specifically disclaims any and all liability, including without limitation special, consequential or incidental damages. Buyer is responsible for its products and applications using ON Semiconductor products, including compliance with all laws, regulations and safety requirements or standards, regardless of any support or applications information provided by ON Semiconductor. "Typical" parameters which may be provided in ON Semiconductor data sheets and/or specifications can and do vary in different applications and actual performance may vary over time. All operating parameters, including "Typicals" must be validated for each customer application by customer's technical experts. ON Semiconductor does not convey any license under its patent rights nor the rights of others. ON Semiconductor products are not designed, intended, or authorized for use as a critical component in life support systems or any FDA Class 3 medical devices or medical devices with a same or similar classification in a foreign jurisdiction or any devices intended for implantation in the human body. Should Buyer purchase or use ON Semiconductor products for any such unintended or unauthorized application, Buyer shall indemnify and hold ON Semiconductor and its officers, employees, subsidiaries, affiliates, and distributors harmless against all claims, costs, damages, and expenses, and reasonable attorney fees arising out of, directly or indirectly, any claim of personal injury or death associated with such unintended or unauthorized use, even if such claim alleges that ON Semiconductor was negligent regarding the design or manufacture of the part. ON Semiconductor is an Equal Opportunity/Affirmative Action Employer. This literature is subject to all applicable copyright laws and is not for resale in any manner.

PUBLICATION ORDERING INFORMATION

LITERATURE FULFILLMENT:

Email Requests to: orderlit@onsemi.com

ON Semiconductor Website: www.onsemi.com

TECHNICAL SUPPORT

North American Technical Support:
Voice Mail: 1 800-282-9855 Toll Free USA/Canada
Phone: 011 421 33 790 2910

Europe, Middle East and Africa Technical Support:

Phone: 00421 33 790 2910

For additional information, please contact your local Sales Representative