

# NUS1204MN

## Overvoltage Protection IC with Integrated MOSFET

This device represents a new level of safety and integration by combining the NCP304 overvoltage protection circuit (OVP) with a  $-12\text{ V}$  P-Channel power MOSFET. It is specifically designed to protect sensitive electronic circuitry from overvoltage transients and power supply faults. During such hazardous events, the IC quickly disconnects the input supply from the load, thus protecting the load before any damage can occur.

The OVP IC is optimized for applications using an external AC-DC adapter or a car accessory charger to power a portable product or recharge its internal batteries. It has a nominal overvoltage threshold of  $4.725\text{ V}$  which makes it ideal for single cell Li-Ion as well as 3/4 cell NiCD/NiMH applications.

### Features

- Overvoltage Turn-Off Time of Less Than  $20\ \mu\text{s}$
- Accurate Voltage Threshold of  $4.725\text{ V}$ , Nominal
- High Accuracy Undervoltage Threshold of  $2.0\%$
- $-12\text{ V}$  Integrated P-Channel Power MOSFET
- Low  $R_{DS(on)} = 75\text{ m}\Omega$  @  $-4.725\text{ V}$
- Low Profile  $2.0 \times 2.0\text{ mm}$  WDFN6 Package Suitable for Portable Applications
- Maximum Solder Reflow Temperature @  $260^\circ\text{C}$
- This device is manufactured with a Pb-Free external lead finish only.

### Benefits

- Provide Battery Protection
- Integrated Solution Offers Cost and Space Savings
- Integrated Solution Improves System Reliability

### Applications

- Portable Computers and PDAs
- Cell Phones and Handheld Products
- Digital Cameras



ON Semiconductor®

<http://onsemi.com>

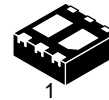

WDFN6  
CASE 506AN

### MARKING DIAGRAM

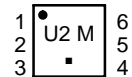

U2 = Specific Device Code  
M = Date Code  
■ = Pb-Free Package

### PIN CONNECTIONS

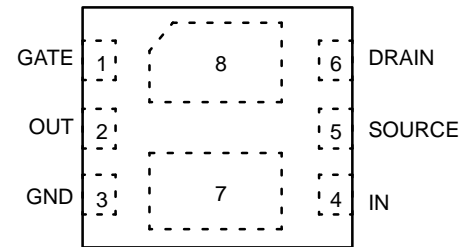

(Top View)

### ORDERING INFORMATION

Device	Package	Shipping†
NUS1204MNT1G	WDFN6 (Pb-Free)	3000 Tape & Reel

†For information on tape and reel specifications, including part orientation and tape sizes, please refer to our Tape and Reel Packaging Specification Brochure, BRD8011/D.

# NUS1204MN

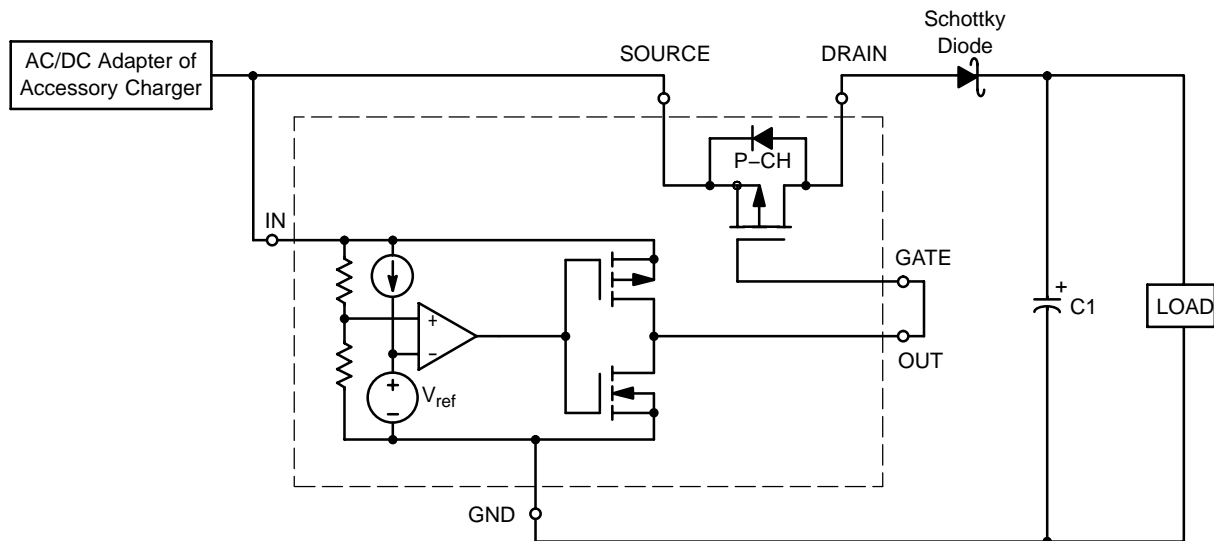

Figure 1. Simplified Schematic

## PIN FUNCTION DESCRIPTIONS

Pin #	Symbol	Pin Description
1	GATE	Gate pin of the P-Channel Power MOSFET
2	OUT	This signal drives the gate of a P-channel Power MOSFET. It is controlled by the voltage level on the IN pin. When an overvoltage event is detected, the OUT pin is driven to within 1.0 V of $V_{IN}$ in less than 20 $\mu$ sec provided that gate and stray capacitance is less than 12 nF.
3, 7	GND	Circuit Ground
4	IN	This pin senses an external voltage point. If the voltage on this input rises above the overvoltage threshold ( $V_{TH}$ ), the OUT pin will be driven to within 1.0 V of $V_{IN}$ , thus disconnecting the P-Channel Power MOSFET. The nominal threshold level is 4.725 V and this threshold level can be increased with the addition of an external resistor between the IN pin and the adapter.
5	SOURCE	Source pin of the P-Channel Power MOSFET
6, 8	DRAIN	Drain pin of the P-Channel Power MOSFET

## OVERVOLTAGE PROTECTION CIRCUIT TRUTH TABLE

IN	OUT
$<V_{th}$	GND
$>V_{th}$	$V_{IN}$

# NUS1204MN

## MAXIMUM RATINGS (T<sub>A</sub> = 25°C unless otherwise stated)

Rating	Pin	Symbol	Min	Max	Unit
OUT Voltage to GND	2	V <sub>O</sub>	-0.3	12	V
Input Pin Voltage to GND	4	V <sub>input</sub>	-0.3	12	V
Maximum Power Dissipation (Note 1)	-	P <sub>D</sub>	-	0.96	W
Thermal Resistance Junction-to-Air (Note 1)		R <sub>θJA</sub>	-	130 130	°C/W
Junction Temperature	-	T <sub>J</sub>	-	150	°C
Operating Ambient Temperature	-	T <sub>A</sub>	-40	85	°C
Storage Temperature Range	-	T <sub>stg</sub>	-65	150	°C
ESD Performance (HBM) (Note 2)	2,3,4	-	2.5	-	kV
Drain-to-Source Voltage		V <sub>DSS</sub>		-12	V
Gate-to-Source Voltage		V <sub>GS</sub>	-8	8	V
Continuous Drain Current, Steady State, T <sub>A</sub> = 25°C (Note 1)		I <sub>D</sub>		-0.6	A

Stresses exceeding Maximum Ratings may damage the device. Maximum Ratings are stress ratings only. Functional operation above the Recommended Operating Conditions is not implied. Extended exposure to stresses above the Recommended Operating Conditions may affect device reliability.

1. Surface-mounted on FR4 board using 1 inch sq pad size (Cu area = 1.127 in sq [1 oz] including traces).
2. Human body model (HBM): MIL STD 883C Method 3015-7, (R = 1500 Ω, C = 100 pF, F = 3 pulses delay 1 s).

## ELECTRICAL CHARACTERISTICS (T<sub>A</sub> = 25°C, V<sub>CC</sub> = 6.0 V, unless otherwise specified)

Characteristic	Symbol	Min	Typ	Max	Unit
Input Threshold (Pin 4, V <sub>in</sub> Increasing)	V <sub>TH</sub>	4.630	4.725	4.820	V
Input Threshold Hysteresis (Pin 4, V <sub>in</sub> Decreasing)	V <sub>HYS</sub>	0.135	0.225	0.315	V
Supply Current (Pin 4) (V <sub>in</sub> = 4.34 V) (V <sub>in</sub> = 6.5 V)	I <sub>in</sub>	-	-	3.0 3.9	μA
Minimum Operating Voltage (Pin 4) (Note 3) (T <sub>A</sub> = 25°C) (T <sub>A</sub> = -40°C to 85°C)	V <sub>in(min)</sub>	-	0.55 0.65	0.70 0.80	V
Output Voltage High (V <sub>in</sub> = 8.0 V; I <sub>Source</sub> = 1.0 mA) Output Voltage High (V <sub>in</sub> = 8.0 V; I <sub>Source</sub> = 0.25 mA) Output Voltage High (V <sub>in</sub> = 8.0 V; I <sub>Source</sub> = 0 mA)	V <sub>oh</sub>	V <sub>in</sub> -1.0 V <sub>in</sub> -0.25 V <sub>in</sub> -0.1	-	-	V
Output Voltage Low (Input < 4.5 V; I <sub>sink</sub> = 0 mA; CNTRL = 0 V)	V <sub>ol</sub>	-	-	0.1	V
Propagation Delay Input to Output Complementary Output NCP304 Series Output Transition, High to Low Output Transition, Low to High	t <sub>pHL</sub> t <sub>pLH</sub>	-	10 21	- 60	μs

3. Guaranteed by design.

# NUS1204MN

**P-CHANNEL MOSFET** ( $T_A = 25^\circ\text{C}$ , unless otherwise specified)

Parameter	Symbol	Min	Typ	Max	Units
Drain to Source On Resistance $V_{GS} = -4.5\text{ V}$ , $I_D = 600\text{ mA}$ $V_{GS} = -4.5\text{ V}$ , $I_D = 1.0\text{ A}$	$R_{DS(on)}$		75 75	100 100	$\text{m}\Omega$
Zero Gate Voltage Drain Current $V_{GS} = -4.5\text{ V}$ , $V_{GS} = 0\text{ V}$ , $V_{DS} = -10\text{ V}$	$I_{DSS}$			-1.0	$\mu\text{A}$
Turn On Delay (Note 4) $V_{GS} = -4.5\text{ V}$	$t_{on}$		5.5		ns
Turn Off Delay (Note 4) $V_{GS} = -4.5\text{ V}$	$t_{off}$		20		ns
Input Capacitance $V_{GS} = 0\text{ V}$ , $f = 1.0\text{ MHz}$ , $V_{DS} = -10\text{ V}$	$C_{in}$		531		pF
Gate to Source Leakage Current $V_{GS} = 8.0\text{ V}$ , $V_{DS} = 0\text{ V}$	$I_{GSS}$		$\pm 10$		nA
Drain to Source Breakdown Voltage $V_{GS} = 0\text{ V}$ , $I_D = -250\text{ }\mu\text{A}$	$V_{(BR)DSS}$	-12			V
Gate Threshold Voltage $V_{GS} = V_{DS}$ , $I_D = -250\text{ }\mu\text{A}$	$V_{(GS)th}$	-0.4	-0.7	-1.0	V

4. Switching characteristics are independent of operating junction temperature.

# MECHANICAL CASE OUTLINE

## PACKAGE DIMENSIONS

ON Semiconductor®

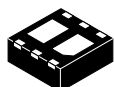

SCALE 4:1

WDFN6 2x2, 0.65P  
CASE 506AN  
ISSUE G

DATE 22 AUG 2013

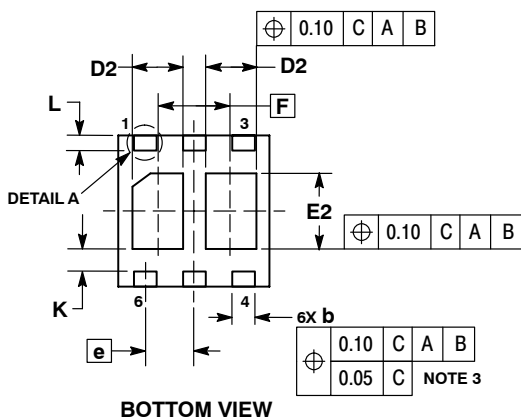
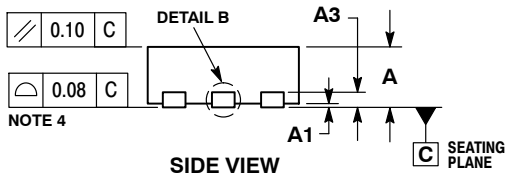
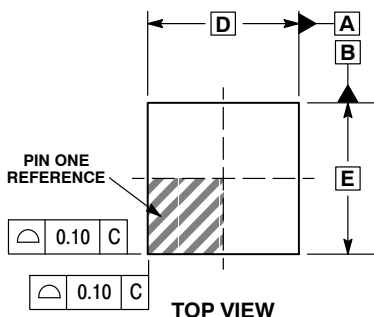

- |   |   |   |
|---|---|---|
| <p>STYLE 1:</p> <p>PIN 1. SOURCE 1</p> <p>2. GATE 1</p> <p>3. DRAIN 2</p> <p>4. SOURCE 2</p> <p>5. GATE 2</p> <p>6. DRAIN 1</p> | <p>STYLE 2:</p> <p>PIN 1. ANODE</p> <p>2. N/C</p> <p>3. DRAIN</p> <p>4. SOURCE</p> <p>5. GATE</p> <p>6. CATHODE</p> | <p>STYLE 3:</p> <p>PIN 1. SOURCE 1</p> <p>2. GATE 1</p> <p>3. SOURCE 2</p> <p>4. DRAIN 2</p> <p>5. GATE 2</p> <p>6. DRAIN 1</p> |
|---|---|---|

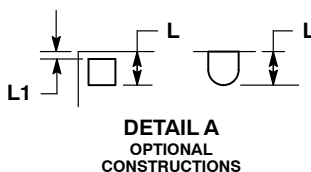
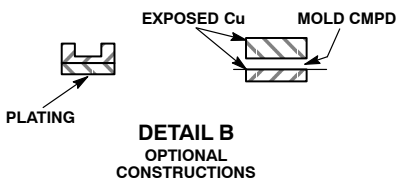

- NOTES:
1. DIMENSIONING AND TOLERANCING PER ASME Y14.5M, 1994.
  2. CONTROLLING DIMENSION: MILLIMETERS.
  3. DIMENSION b APPLIES TO PLATED TERMINAL AND IS MEASURED BETWEEN 0.15 AND 0.30 mm FROM THE TERMINAL TIP.
  4. COPLANARITY APPLIES TO THE EXPOSED PAD AS WELL AS THE TERMINALS.

DIM	MILLIMETERS	
	MIN	MAX
A	0.70	0.80
A1	0.00	0.05
A3	0.20 REF	
b	0.25	0.35
D	2.00 BSC	
D2	0.57	0.77
E	2.00 BSC	
E2	0.90	1.10
e	0.65 BSC	
F	0.95 BSC	
K	0.25 REF	
L	0.20	0.30
L1	---	0.10

### GENERIC MARKING DIAGRAM\*

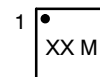

XX = Specific Device Code  
M = Date Code

\*This information is generic. Please refer to device data sheet for actual part marking. Pb-Free indicator, "G" or microdot "μ", may or may not be present.

### SOLDERMASK DEFINED MOUNTING FOOTPRINT

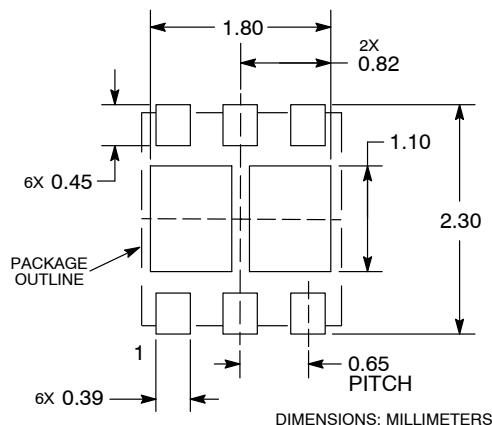

DOCUMENT NUMBER:	98AON20861D	Electronic versions are uncontrolled except when accessed directly from the Document Repository. Printed versions are uncontrolled except when stamped "CONTROLLED COPY" in red.
DESCRIPTION:	WDFN6 2X2, 0.65P	PAGE 1 OF 1

ON Semiconductor and ON are trademarks of Semiconductor Components Industries, LLC dba ON Semiconductor or its subsidiaries in the United States and/or other countries. ON Semiconductor reserves the right to make changes without further notice to any products herein. ON Semiconductor makes no warranty, representation or guarantee regarding the suitability of its products for any particular purpose, nor does ON Semiconductor assume any liability arising out of the application or use of any product or circuit, and specifically disclaims any and all liability, including without limitation special, consequential or incidental damages. ON Semiconductor does not convey any license under its patent rights nor the rights of others.

**onsemi**, **Onsemi**, and other names, marks, and brands are registered and/or common law trademarks of Semiconductor Components Industries, LLC dba "**onsemi**" or its affiliates and/or subsidiaries in the United States and/or other countries. **onsemi** owns the rights to a number of patents, trademarks, copyrights, trade secrets, and other intellectual property. A listing of **onsemi**'s product/patent coverage may be accessed at [www.onsemi.com/site/pdf/Patent-Marking.pdf](http://www.onsemi.com/site/pdf/Patent-Marking.pdf). **onsemi** reserves the right to make changes at any time to any products or information herein, without notice. The information herein is provided "as-is" and **onsemi** makes no warranty, representation or guarantee regarding the accuracy of the information, product features, availability, functionality, or suitability of its products for any particular purpose, nor does **onsemi** assume any liability arising out of the application or use of any product or circuit, and specifically disclaims any and all liability, including without limitation special, consequential or incidental damages. Buyer is responsible for its products and applications using **onsemi** products, including compliance with all laws, regulations and safety requirements or standards, regardless of any support or applications information provided by **onsemi**. "Typical" parameters which may be provided in **onsemi** data sheets and/or specifications can and do vary in different applications and actual performance may vary over time. All operating parameters, including "Typicals" must be validated for each customer application by customer's technical experts. **onsemi** does not convey any license under any of its intellectual property rights nor the rights of others. **onsemi** products are not designed, intended, or authorized for use as a critical component in life support systems or any FDA Class 3 medical devices or medical devices with a same or similar classification in a foreign jurisdiction or any devices intended for implantation in the human body. Should Buyer purchase or use **onsemi** products for any such unintended or unauthorized application, Buyer shall indemnify and hold **onsemi** and its officers, employees, subsidiaries, affiliates, and distributors harmless against all claims, costs, damages, and expenses, and reasonable attorney fees arising out of, directly or indirectly, any claim of personal injury or death associated with such unintended or unauthorized use, even if such claim alleges that **onsemi** was negligent regarding the design or manufacture of the part. **onsemi** is an Equal Opportunity/Affirmative Action Employer. This literature is subject to all applicable copyright laws and is not for resale in any manner.

## PUBLICATION ORDERING INFORMATION

### LITERATURE FULFILLMENT:

Email Requests to: [orderlit@onsemi.com](mailto:orderlit@onsemi.com)

**onsemi Website:** [www.onsemi.com](http://www.onsemi.com)

### TECHNICAL SUPPORT

**North American Technical Support:**

Voice Mail: 1 800-282-9855 Toll Free USA/Canada

Phone: 011 421 33 790 2910

**Europe, Middle East and Africa Technical Support:**

Phone: 00421 33 790 2910

For additional information, please contact your local Sales Representative