

MOSFET - Power, Single N-Channel, SUPERFET® V, FRFET®, TO247-3L

600 V, 40 mΩ, 59 A

NVHL040N60S5F

Description

The SUPERFET V MOSFET FRFET series has optimized body diode performance characteristics. This can allow for the removal of components in the application and improve application performance and reliability, particularly when soft switching topologies are used.

Features

- 650 V @ $T_J = 150^\circ\text{C}$ / Typ. $R_{DS(on)} = 32\text{ m}\Omega$
- 100% Avalanche Tested
- Pb-Free, Halogen Free/BFR Free and are RoHS Compliant

Applications

- Electric Vehicle On Board Chargers
- EV Main Battery DC/DC Converters

ABSOLUTE MAXIMUM RATINGS ($T_J = 25^\circ\text{C}$, Unless otherwise noted)

Parameter	Symbol	Value	Unit
Drain-to-Source Voltage	V_{DSS}	600	V
Gate-to-Source Voltage	DC	V_{GSS}	± 30
		AC ($f > 1\text{ Hz}$)	± 30
Continuous Drain Current	I_D	$T_C = 25^\circ\text{C}$	59
		$T_C = 100^\circ\text{C}$	37
Power Dissipation	$T_C = 25^\circ\text{C}$	P_D	347
Pulsed Drain Current (Note 1)	$T_C = 25^\circ\text{C}$	I_{DM}	209
Pulsed Source Current (Body Diode) (Note 1)	$T_C = 25^\circ\text{C}$	I_{SM}	209
Operating Junction and Storage Temperature Range	T_J, T_{STG}	-55 to +150	$^\circ\text{C}$
Source Current (Body Diode)	I_S	59	A
Single Pulse Avalanche Energy	$I_L = 8.3\text{ A}, R_G = 25\ \Omega$	E_{AS}	574
Avalanche Current	I_{AS}	8.3	A
Repetitive Avalanche Energy (Note 1)	E_{AR}	3.47	mJ
MOSFET dv/dt	dv/dt	120	V/ns
Peak Diode Recovery dv/dt (Note 2)		70	
Lead Temperature for Soldering Purposes (1/8" from case for 10 seconds)	T_L	260	$^\circ\text{C}$

Stresses exceeding those listed in the Maximum Ratings table may damage the device. If any of these limits are exceeded, device functionality should not be assumed, damage may occur and reliability may be affected.

1. Repetitive rating: pulse-width limited by maximum junction temperature.
2. $I_{SD} \leq 29.5\text{ A}$, $di/dt \leq 200\text{ A}/\mu\text{s}$, $V_{DD} \leq 400\text{ V}$, starting $T_J = 25^\circ\text{C}$.

V_{DSS}	$R_{DS(ON)}\text{ MAX}$	$I_D\text{ MAX}$
600 V	40 mΩ @ 10 V	59 A

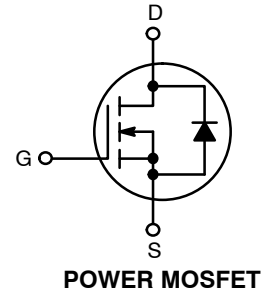

MARKING DIAGRAM



V040N60S5F = Specific Device Code
A = Assembly Location
YWW = Date Code (Year & Week)
ZZ = Assembly Lot

ORDERING INFORMATION

Device	Package	Shipping
NVHL040N60S5F	TO-247	30 Units / Tube

NVHL040N60S5F

THERMAL CHARACTERISTICS

Parameter	Symbol	Value	Unit
Thermal Resistance, Junction-to-Case, Max.	$R_{\theta JC}$	0.36	°C/W
Thermal Resistance, Junction-to-Ambient, Max.	$R_{\theta JA}$	40	

ELECTRICAL CHARACTERISTICS ($T_J = 25^\circ\text{C}$ unless otherwise noted)

Parameter	Symbol	Test Conditions	Min	Typ	Max	Unit
-----------	--------	-----------------	-----	-----	-----	------

OFF CHARACTERISTICS

Drain-to-Source Breakdown Voltage	$V_{(BR)DSS}$	$V_{GS} = 0\text{ V}, I_D = 1\text{ mA}, T_J = 25^\circ\text{C}$	600	-	-	V
Drain-to-Source Breakdown Voltage Temperature Coefficient	$\Delta V_{(BR)DSS} / \Delta T_J$	$I_D = 10\text{ mA}$, Referenced to 25°C	-	630	-	mV/°C
Zero Gate Voltage Drain Current	I_{DSS}	$V_{GS} = 0\text{ V}, V_{DS} = 600\text{ V}, T_J = 25^\circ\text{C}$	-	-	10	μA
Gate-to-Source Leakage Current	I_{GSS}	$V_{GS} = \pm 30\text{ V}, V_{DS} = 0\text{ V}$	-	-	±100	nA

ON CHARACTERISTICS

Drain-to-Source On Resistance	$R_{DS(on)}$	$V_{GS} = 10\text{ V}, I_D = 29.5\text{ A}, T_J = 25^\circ\text{C}$	-	32	40	mΩ
Gate Threshold Voltage	$V_{GS(th)}$	$V_{GS} = V_{DS}, I_D = 7.2\text{ mA}, T_J = 25^\circ\text{C}$	3.2	-	4.8	V
Forward Trans-conductance	g_{FS}	$V_{DS} = 20\text{ V}, I_D = 29.5\text{ A}$	-	59.5	-	S

CHARGES, CAPACITANCES & GATE RESISTANCE

Input Capacitance	C_{ISS}	$V_{DS} = 400\text{ V}, V_{GS} = 0\text{ V}, f = 250\text{ kHz}$	-	6318	-	pF
Output Capacitance	C_{OSS}		-	98.9	-	
Time Related Output Capacitance	$C_{OSS(tr)}$	$I_D = \text{Constant}, V_{DS} = 0\text{ V to } 400\text{ V}, V_{GS} = 0\text{ V}$	-	1478	-	
Energy Related Output Capacitance	$C_{OSS(er)}$		$V_{DS} = 0\text{ V to } 400\text{ V}, V_{GS} = 0\text{ V}$	-	170	
Total Gate Charge	$Q_{G(tot)}$	$V_{DD} = 400\text{ V}, I_D = 29.5\text{ A}, V_{GS} = 10\text{ V}$	-	115	-	nC
Gate-to-Source Charge	Q_{GS}		-	35.9	-	
Gate-to-Drain Charge	Q_{GD}		-	32.7	-	
Gate Resistance	R_G		$f = 1\text{ MHz}$	-	4.5	

SWITCHING CHARACTERISTICS

Turn-On Delay Time	$t_{d(on)}$	$V_{GS} = 0/10\text{ V}, V_{DD} = 400\text{ V}, I_D = 29.5\text{ A}, R_G = 2.2\text{ }\Omega$	-	49.6	-	ns
Rise Time	t_r		-	85.9	-	
Turn-Off Delay Time	$t_{d(off)}$		-	110	-	
Fall Time	t_f		-	2.5	-	

SOURCE-TO-DRAIN DIODE CHARACTERISTICS

Forward Diode Voltage	V_{SD}	$V_{GS} = 0\text{ V}, I_{SD} = 29.5\text{ A}, T_J = 25^\circ\text{C}$	-	-	1.2	V
Reverse Recovery Time	t_{RR}	$V_{GS} = 0\text{ V}, I_{SD} = 29.5\text{ A}, di/dt = 100\text{ A}/\mu\text{s}, V_{DD} = 400\text{ V}$	-	140	-	ns
Reverse Recovery Charge	Q_{RR}		-	917	-	nC

Product parametric performance is indicated in the Electrical Characteristics for the listed test conditions, unless otherwise noted. Product performance may not be indicated by the Electrical Characteristics if operated under different conditions.

NVHL040N60S5F

TYPICAL CHARACTERISTICS

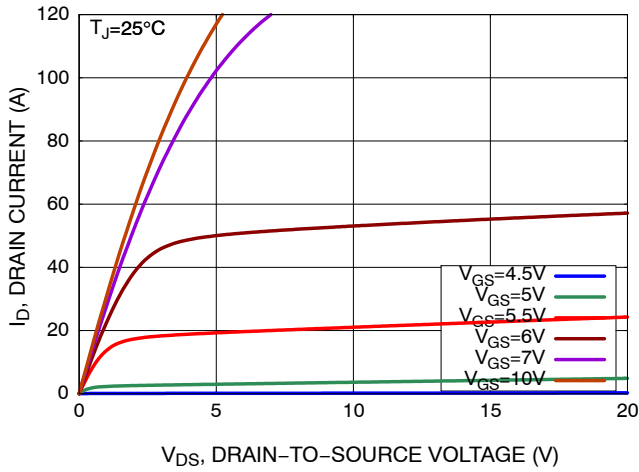

Figure 1. On-Region Characteristics

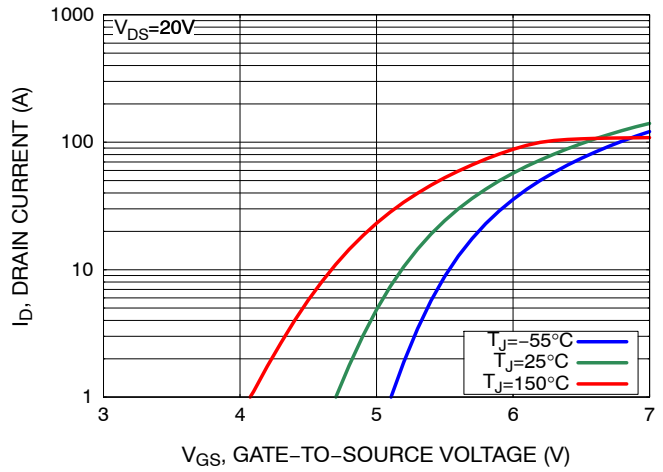

Figure 2. Transfer Characteristics

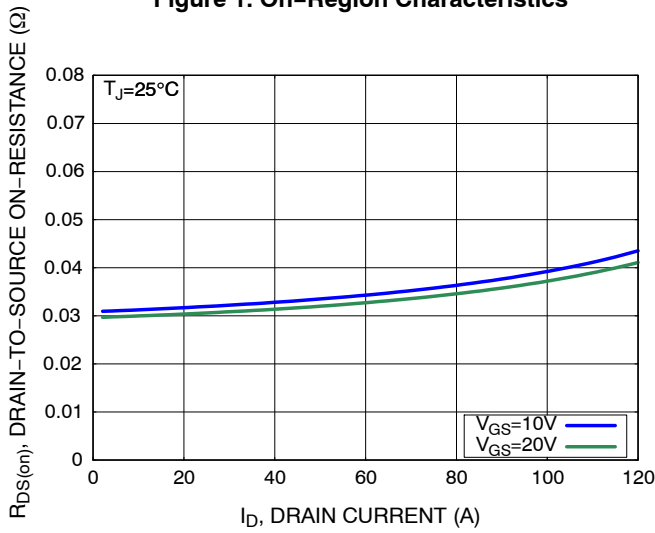

Figure 3. On-Resistance Variation vs. Drain Current and Gate Voltage

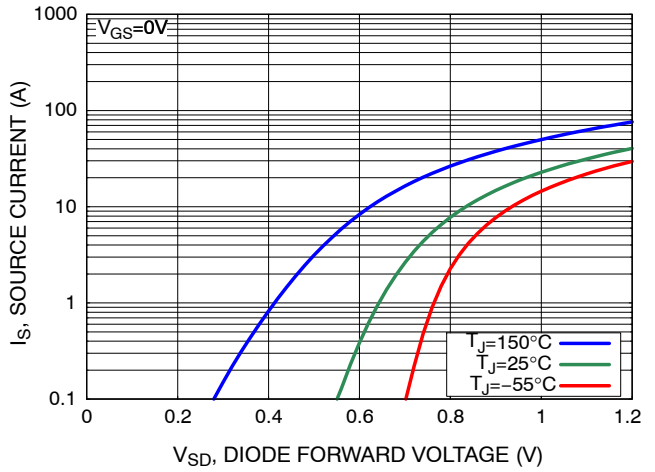

Figure 4. Diode Forward Voltage vs. Source Current

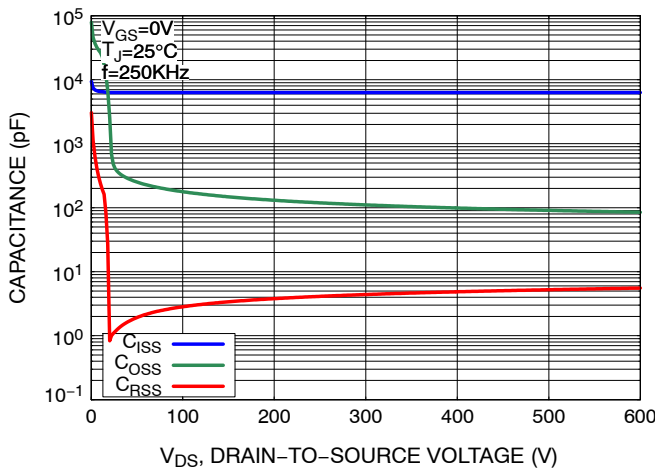

Figure 5. Capacitance Characteristics

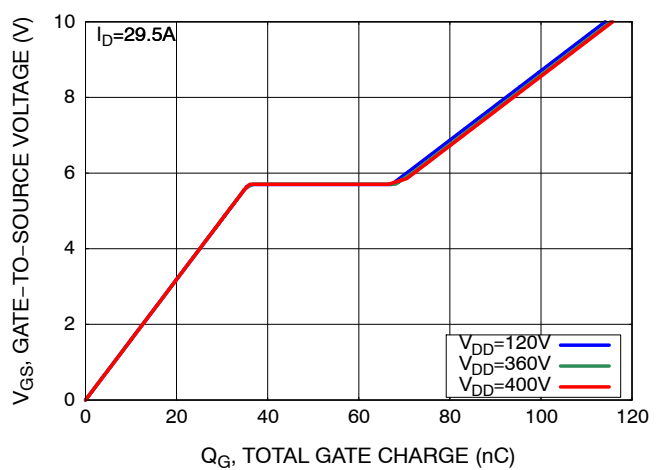

Figure 6. Gate Charge Characteristics

NVHL040N60S5F

TYPICAL CHARACTERISTICS

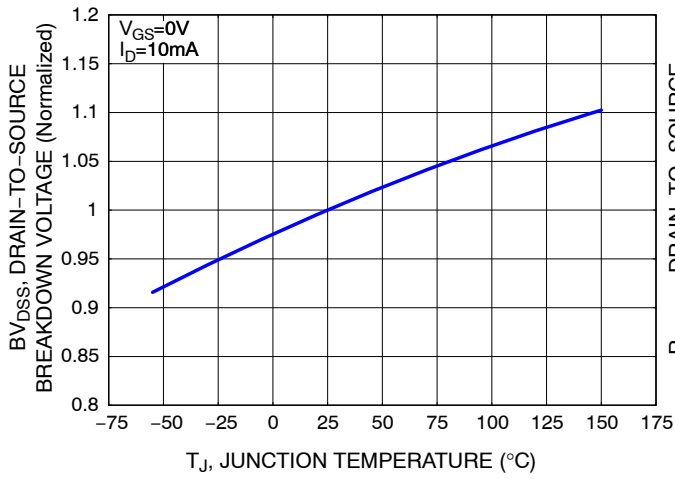

Figure 7. Breakdown Voltage Variation vs. Temperature

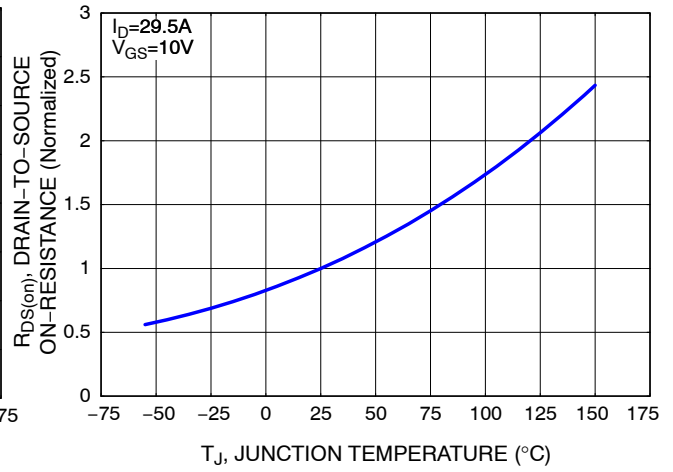

Figure 8. On-Resistance Variation vs. Temperature

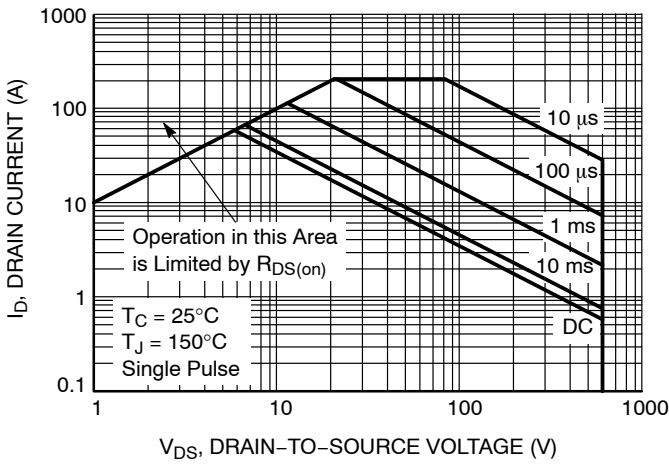

Figure 9. Maximum Safe Operating Area

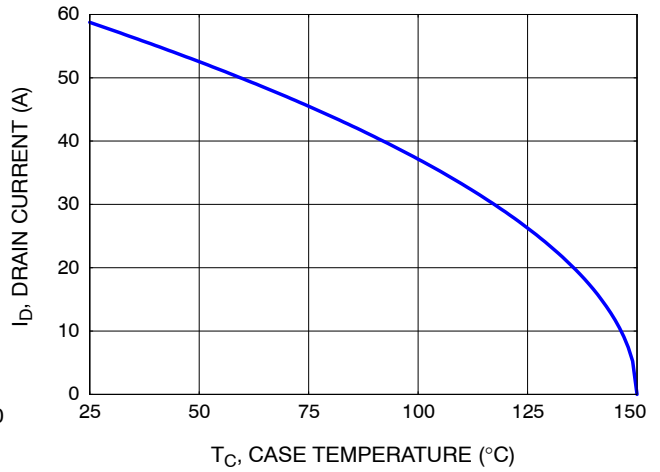

Figure 10. Maximum Drain Current vs. Case Temperature

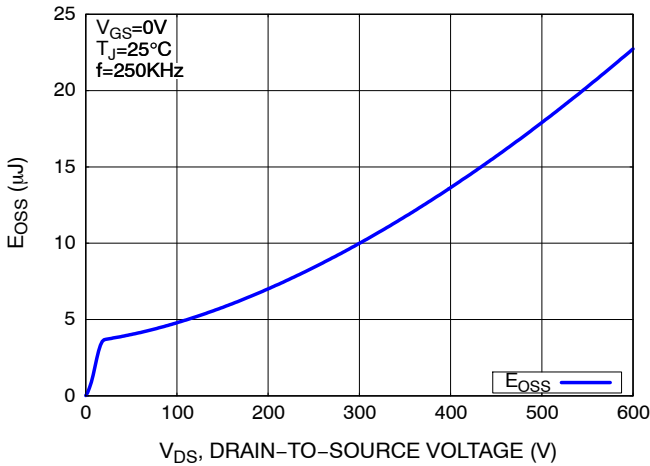

Figure 11. E_{OSS} vs. Drain-to-Source Voltage

NVHL040N60S5F

TYPICAL CHARACTERISTICS

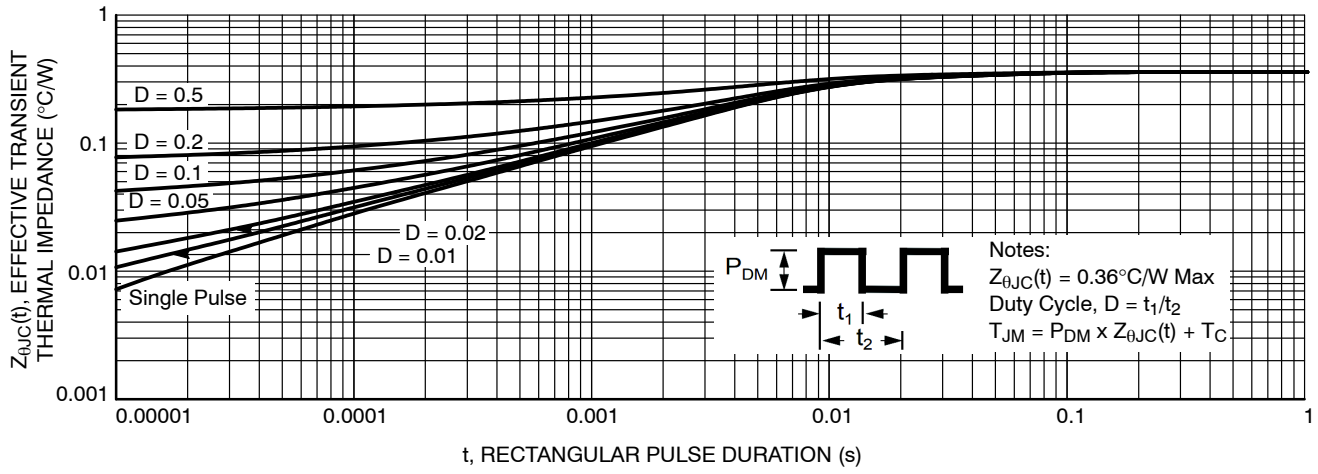

Figure 12. Transient Thermal Impedance

NVHL040N60S5F



Figure 13. Gate Charge Test Circuit & Waveform

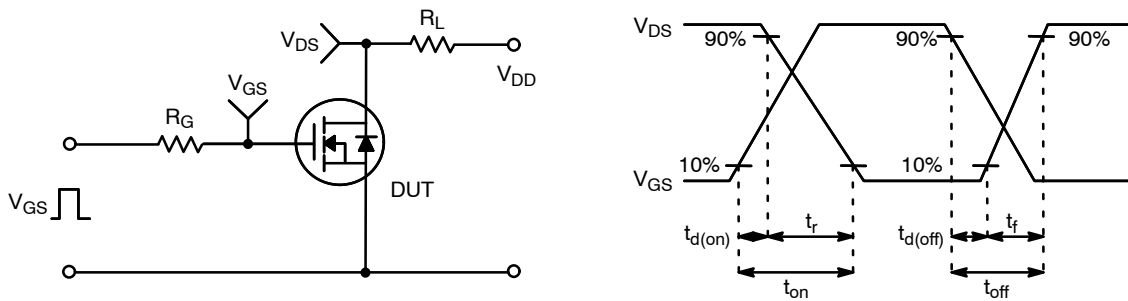

Figure 14. Resistive Switching Test Circuit & Waveforms

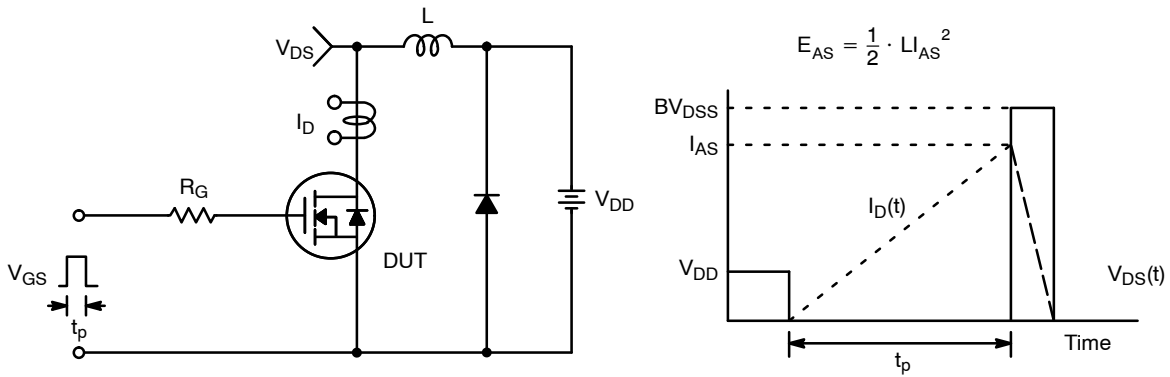

Figure 15. Unclamped Inductive Switching Test Circuit & Waveforms

NVHL040N60S5F



Figure 16. Peak Diode Recovery dv/dt Test Circuit & Waveforms

MECHANICAL CASE OUTLINE

PACKAGE DIMENSIONS

ON Semiconductor®



TO-247-3LD
CASE 340CX
ISSUE A

DATE 06 JUL 2020



NOTES: UNLESS OTHERWISE SPECIFIED.

- A. DIMENSIONS ARE EXCLUSIVE OF BURRS, MOLD FLASH, AND TIE BAR EXTRUSIONS.
- B. ALL DIMENSIONS ARE IN MILLIMETERS.
- C. DRAWING CONFORMS TO ASME Y14.5 - 2009.
- D. DIMENSION A1 TO BE MEASURED IN THE REGION DEFINED BY L1.
- E. LEAD FINISH IS UNCONTROLLED IN THE REGION DEFINED BY L1.

DIM	MILLIMETERS		
	MIN	NOM	MAX
A	4.58	4.70	4.82
A1	2.20	2.40	2.60
A2	1.40	1.50	1.60
D	20.32	20.57	20.82
E	15.37	15.62	15.87
E2	4.96	5.08	5.20
e	~	5.56	~
L	19.75	20.00	20.25
L1	3.69	3.81	3.93
ØP	3.51	3.58	3.65
Q	5.34	5.46	5.58
S	5.34	5.46	5.58
b	1.17	1.26	1.35
b2	1.53	1.65	1.77
b4	2.42	2.54	2.66
c	0.51	0.61	0.71
D1	13.08	~	~
D2	0.51	0.93	1.35
E1	12.81	~	~
ØP1	6.60	6.80	7.00

GENERIC MARKING DIAGRAM*



- XXXXX = Specific Device Code
- A = Assembly Location
- Y = Year
- WW = Work Week
- G = Pb-Free Package

*This information is generic. Please refer to device data sheet for actual part marking. Pb-Free indicator, "G" or microdot "▪", may or may not be present. Some products may not follow the Generic Marking.

DOCUMENT NUMBER:	98AON93302G	Electronic versions are uncontrolled except when accessed directly from the Document Repository. Printed versions are uncontrolled except when stamped "CONTROLLED COPY" in red.
DESCRIPTION:	TO-247-3LD	PAGE 1 OF 1

ON Semiconductor and are trademarks of Semiconductor Components Industries, LLC dba ON Semiconductor or its subsidiaries in the United States and/or other countries. ON Semiconductor reserves the right to make changes without further notice to any products herein. ON Semiconductor makes no warranty, representation or guarantee regarding the suitability of its products for any particular purpose, nor does ON Semiconductor assume any liability arising out of the application or use of any product or circuit, and specifically disclaims any and all liability, including without limitation special, consequential or incidental damages. ON Semiconductor does not convey any license under its patent rights nor the rights of others.

onsemi, **Onsemi**, and other names, marks, and brands are registered and/or common law trademarks of Semiconductor Components Industries, LLC dba "**onsemi**" or its affiliates and/or subsidiaries in the United States and/or other countries. **onsemi** owns the rights to a number of patents, trademarks, copyrights, trade secrets, and other intellectual property. A listing of **onsemi**'s product/patent coverage may be accessed at www.onsemi.com/site/pdf/Patent-Marking.pdf. **onsemi** reserves the right to make changes at any time to any products or information herein, without notice. The information herein is provided "as-is" and **onsemi** makes no warranty, representation or guarantee regarding the accuracy of the information, product features, availability, functionality, or suitability of its products for any particular purpose, nor does **onsemi** assume any liability arising out of the application or use of any product or circuit, and specifically disclaims any and all liability, including without limitation special, consequential or incidental damages. Buyer is responsible for its products and applications using **onsemi** products, including compliance with all laws, regulations and safety requirements or standards, regardless of any support or applications information provided by **onsemi**. "Typical" parameters which may be provided in **onsemi** data sheets and/or specifications can and do vary in different applications and actual performance may vary over time. All operating parameters, including "Typicals" must be validated for each customer application by customer's technical experts. **onsemi** does not convey any license under any of its intellectual property rights nor the rights of others. **onsemi** products are not designed, intended, or authorized for use as a critical component in life support systems or any FDA Class 3 medical devices or medical devices with a same or similar classification in a foreign jurisdiction or any devices intended for implantation in the human body. Should Buyer purchase or use **onsemi** products for any such unintended or unauthorized application, Buyer shall indemnify and hold **onsemi** and its officers, employees, subsidiaries, affiliates, and distributors harmless against all claims, costs, damages, and expenses, and reasonable attorney fees arising out of, directly or indirectly, any claim of personal injury or death associated with such unintended or unauthorized use, even if such claim alleges that **onsemi** was negligent regarding the design or manufacture of the part. **onsemi** is an Equal Opportunity/Affirmative Action Employer. This literature is subject to all applicable copyright laws and is not for resale in any manner.

PUBLICATION ORDERING INFORMATION

LITERATURE FULFILLMENT:

Email Requests to: orderlit@onsemi.com

onsemi Website: www.onsemi.com

TECHNICAL SUPPORT

North American Technical Support:

Voice Mail: 1 800-282-9855 Toll Free USA/Canada

Phone: 011 421 33 790 2910

Europe, Middle East and Africa Technical Support:

Phone: 00421 33 790 2910

For additional information, please contact your local Sales Representative