



Is Now Part of



ON Semiconductor®

To learn more about ON Semiconductor, please visit our website at
www.onsemi.com

ON Semiconductor and the ON Semiconductor logo are trademarks of Semiconductor Components Industries, LLC dba ON Semiconductor or its subsidiaries in the United States and/or other countries. ON Semiconductor owns the rights to a number of patents, trademarks, copyrights, trade secrets, and other intellectual property. A listing of ON Semiconductor's product/patent coverage may be accessed at www.onsemi.com/site/pdf/Patent-Marking.pdf. ON Semiconductor reserves the right to make changes without further notice to any products herein. ON Semiconductor makes no warranty, representation or guarantee regarding the suitability of its products for any particular purpose, nor does ON Semiconductor assume any liability arising out of the application or use of any product or circuit, and specifically disclaims any and all liability, including without limitation special, consequential or incidental damages. Buyer is responsible for its products and applications using ON Semiconductor products, including compliance with all laws, regulations and safety requirements or standards, regardless of any support or applications information provided by ON Semiconductor. "Typical" parameters which may be provided in ON Semiconductor data sheets and/or specifications can and do vary in different applications and actual performance may vary over time. All operating parameters, including "Typicals" must be validated for each customer application by customer's technical experts. ON Semiconductor does not convey any license under its patent rights nor the rights of others. ON Semiconductor products are not designed, intended, or authorized for use as a critical component in life support systems or any FDA Class 3 medical devices or medical devices with a same or similar classification in a foreign jurisdiction or any devices intended for implantation in the human body. Should Buyer purchase or use ON Semiconductor products for any such unintended or unauthorized application, Buyer shall indemnify and hold ON Semiconductor and its officers, employees, subsidiaries, affiliates, and distributors harmless against all claims, costs, damages, and expenses, and reasonable attorney fees arising out of, directly or indirectly, any claim of personal injury or death associated with such unintended or unauthorized use, even if such claim alleges that ON Semiconductor was negligent regarding the design or manufacture of the part. ON Semiconductor is an Equal Opportunity/Affirmative Action Employer. This literature is subject to all applicable copyright laws and is not for resale in any manner.



AN-6609

Selecting the Best JFET for Your Application

Introduction

This application note contains design curves for all of Fairchild Semiconductor discrete JFET processes. JFET process characteristics provide complete information on all processes, including all parts manufactured from a particular process. This can greatly aid device selection or substitution. In all cases, temperature and $V_{GS(off)}$ distribution data is provided to facilitate worst-case design. In addition, a complete list of all device types supplied from this process is included to aid in cross reference searches and the selection of preferred device types. Preferred parts are shown with gray overprinting. The curves in this section should be considered typical of the process supplied by Fairchild Semiconductor. Every effort is made to keep the process in tolerance with the published graphs, but the exact distribution of any specific lot of material is not guaranteed.

How to use the Application Note

The following suggested procedure will help you find the device you need.

Part Number Known: Go to the Fairchild web site and type in the part number. If alternate type is required, refer to the online cross reference guide.

Specification Known: Refer to Figure 2, "JFET Process Family Tree" on page 4 of this application note to find the most compatible process. Then turn to Figure 3, "JFET Process Comparison Curves", on page 6 to compare the specifications of each process type. Finally, turn to page 16 for a detailed listing of process characteristics and specific

device type numbers available in that process. Take special note of preferred part types. Full data sheets are available on line.

Application Known: Turn to "Choose the Proper FET" and Figure 2, "JFET Process Tree" on page 4. Also Table 2, "Advantages of Using JFET by Application" on page 3. Finally, refer to 0, "Applications and Their Parameters in Approximate Order of Importance" on page 2 as needed.

None of the Above: Contact local representative or regional office for assistance.

JFET Application Guide

Fairchild Semiconductor manufactures a broad line of silicon junction field effect transistors (JFETs). Fairchild's JFETs provide excellent performance in many application areas such as RF amplifiers, analog switching low input current amplifiers, ultra low noise amplifiers and outstanding matched duals for operational amplifiers input applications.

Table 1 is a guide to enable the user to determine what parameters are important in each application. This followed by a listing of JFET Parameter Relationships in Figure 1. Table 2 lists many application advantages of JFETs by application.

Table of Contents

Table 1. Applications and Their Parameters in Approximate Order of Importance

LOW FREQUENCY AMPLIFIER	SOURCE FOLLOWER	ELECTROMETER AMPLIFIERS	LOW DRIFT AMPLIFIER	LOW NOISE AMPLIFIER	HIGH FREQUENCY AMPLIFIER	OSCILLATOR	DIFFERENTIAL AMPLIFIER	ANALOG AND DIGITAL SWITCHING
Y _{fs} I _{DSS}	Y _{fs} I _G	I _G Y _{fs}	I _{DZ} Y _{fs} @ I _{DZ}	e _n I _G , i _n	Re(Y _{fs}) Re(Y _{is})	Y _{fs} I _{DSS}	$\frac{ V_{GS1}-V_{GS2} }{\Delta T}$	r _{DS(ON)} I _{D(OFF)}
V _{GS(OFF)} C _{iss} C _{rss} e _n BV _{GSS}	C _{rss} C _{iss} I _{DSS} V _{GS(OFF)} BV _{GSS}	I _{DZ} e _n g _{os}	V _{GS} @ I _{DZ} I _G BV _{GSS}	Y _{fs} I _{DSS} V _{GS(OFF)}	NF C _{rss} Re(Y _{os}) I _{DSS} V _{GS(OFF)}	C _{rss} C _{iss} V _{GS(OFF)} BV _{GSS}	$ I_{G1}-I_{G2} $ I _G Y _{fs} Y _{fs1} /Y _{fs2} $ Y_{os1}-Y_{os2} $ CMRR V _{GS(OFF)}	C _{iss} C _{rss} V _{GS(OFF)} BV _{GSS}

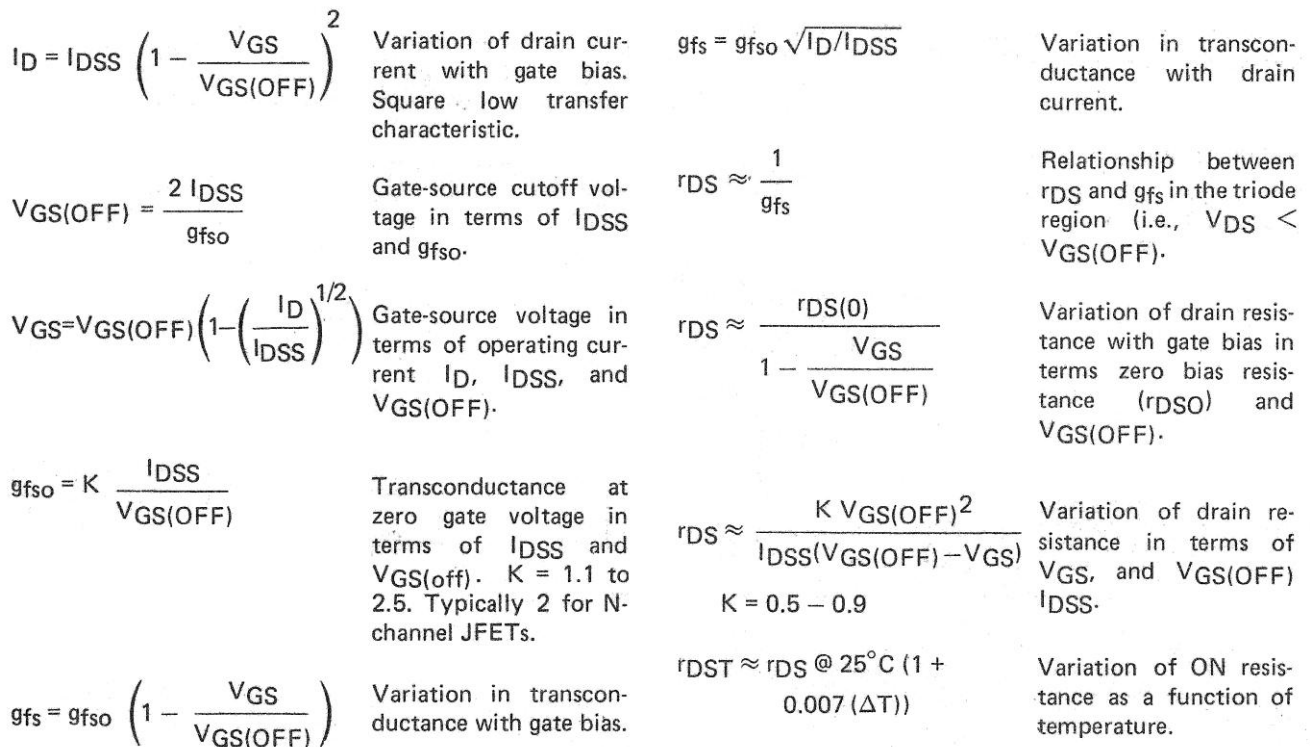

Figure 1. JFET Parameter Relationships

Table 2. Advantages of JFET by Application

APPLICATION	ADVANTAGES	FINAL ASSEMBLY WHERE USED
DC Amplifiers	High Z_{in} Low drift duals Low noise	Transducers, military guidance systems, control systems, temp indicators, multimeters
Low frequency amplifiers	Small coupling capacitors Low noise, distortion High input impedance	Sound detection, microphones, inductive transducers, hearing aids, high impedance transducers
Operational amplifiers	Summing point essentially zero. Low device noise. Less loading of transducers	Control systems, potted op amps, test equipment, medical electronics
Medium and high frequency amplifiers	Low cross modulation Low device noise Simplified circuitry	FM tuners, communication received scope inputs, most instrumentation equipment, high impedance inputs
Mixers — 100 MHz and up	Low mixing noise Low cross modulation	FM tuners, communication receivers
Oscillators	Low drift	Transmitters, receivers, organ
Logic gates	Virtually infinite fan in Simplified circuitry Zero storage time Symmetrical	Guidance controls, computer market mini military teaching aids, traffic control, telemetry
Choppers	Zero offset Low leakage currents Simplified circuitry Eliminates input transformers	Op amp modules guidance controls instrumentation equipment
AD Converters Multiplex switching (arrays) and sample hold	Improved isolation of input and output. Zero offset. Symmetrical. Low resistance Simplified circuitry	Control system, DVM's and any read-out equipment, medical electronics
Relay contact replacement	Solid state reliability Zero offset, High isolation Symmetrical No inductive spring No contact bounce High repetition rate	Test equipment, airborne equipment instrumentation market
Voltage variable resistor	Symmetrical Solid state reliability Functions as variable resistor. Low noise. High isolation Improved resolution	Organ, tone controls, control ckts to input operational amplifiers
Current limiters Sources	Two lead simplicity Wide selection range Low voltage operation	Hybrid circuits, amplifiers, power supply protection, timing ckts, voltage regulators

Choose the Proper JFET

Fairchild Semiconductor utilizes 17 different JFET geometries to cover, without compromise, the full spectrum of applications. Specific part number characteristics are summarized into application areas further on within this app note. In addition, this app note includes process comparison charts which graphically indicate the typical values of a given parameter for all geometries under identical test

conditions. Detailed data on each process, along with a list of all part numbers manufactured from each process, is also supplied.

Figure 2, gives a look at the characteristics for each process type to help the designer select the process that best meets his requirements. Table 3 shows which application the process was designed to best serve. After narrowing down the process types, it is suggested that the process sheets and specific part number characteristics be consulted.

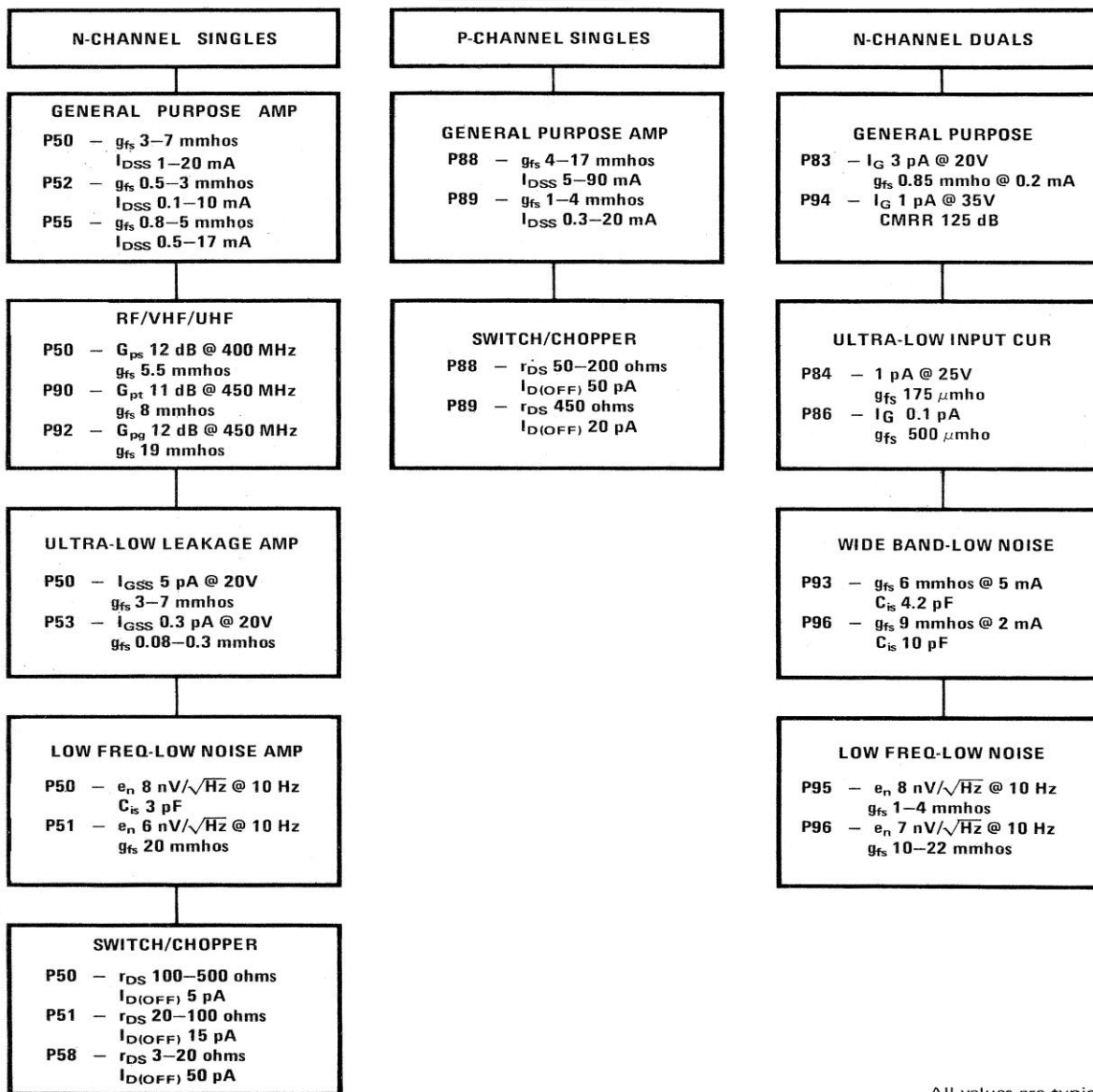

Figure 2. The JFET Process Family Tree

Table 3. Part Number and Process Application Recommendations

POPULAR PRODUCT TYPES	2N4416, 2N5485-6 PN4416, PN4302-4	2N4856-61, 2N4391-3 PN4856-61, PN4391-3	2N4338-41, 2N3684-7	2N4117-9, 2N3452-4 2N4117A-19A	2N3821-2, 2N4221-2 2N5457-9	2N5432-4	2N5196-9, 2N5545-7 2N3954-8	2N5902-9	U421-U426	2N5018-21, P1086-7E 2N5114-6	2N2608-9, 2N5460-62	2N5397, J300	U308-10, J308-10	2N5911-12	NDF9401-10	2N5515-24, 2N6483-5	2N5564-6	2N5561-63
PROCESS DESIGNATION	50	51	52	53	55	58	83	84	86	88	89	90	92	93	94	95	96	98
Low Current Amplifier			S	P	S		P	P	P		P				P	P		P
Low Freq Ampli ≤ 100 Hz			S		S		P			S	S				P	P		P
High Freq Ampli > 100 MHz	P											P	P	P			P	
General Purpose Amplifier	P		P		P						P							
Low Noise Amp (10 Hz \bar{e}_n)	S	S			S	S	P								P	P	P	P
Low Noise Amp > 50 MHz	P				S							P	P	P			P	
High Frequency Mixer	P											P	P					
Dual Diff Pair							P	P	P					P	P	S	P	P
AGC Amplifier	P				P													
Electrometer Preamp				P				P	P						P			S
Microvolt Amplifier				P				P	P						P			P
Low Leakage Diode				P														
Diff/Angle Ended Inp. Staa.							P	P	P					P	P		P	P
Active Filter	P		S		P						S							
Oscillator	P		S		P						S	P	P					
Voltage Variable Resistor	P	P	S		P					P	P							P
Hybrid Chips	P	P		P	P		P	P	P	P	P				P			
Analog/Digital Switch		P				P				P							S	S
Multiplexing	P	P			S	S				P								
Choppers		P				P				P							P	
Nixie Drivers																		
Reed Relay Replacement						P												
Sub pA Dual Diff Pair								P	P									
Sample-Hold	P	P			S				S	P								P
Buffer Interface to CMOS										P	P							
Matched Switch							S							S	S		P	P
HF ≥ 400 MHz Prime												P	P					
Current Limiter		P								P								
Current Source			P	S	P						S							

P – Prime Choice S – Secondary (Alternate) Choice

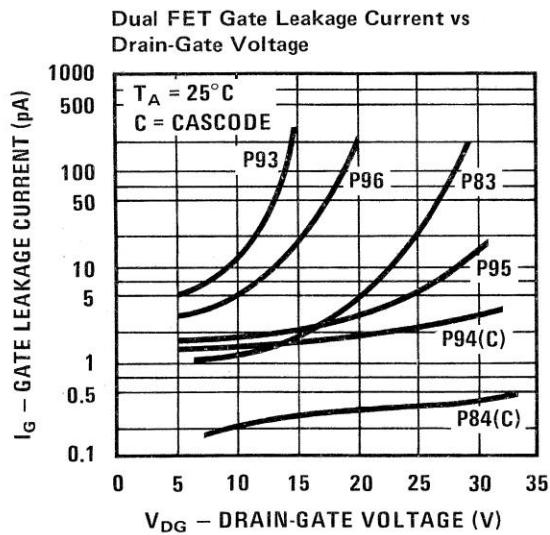
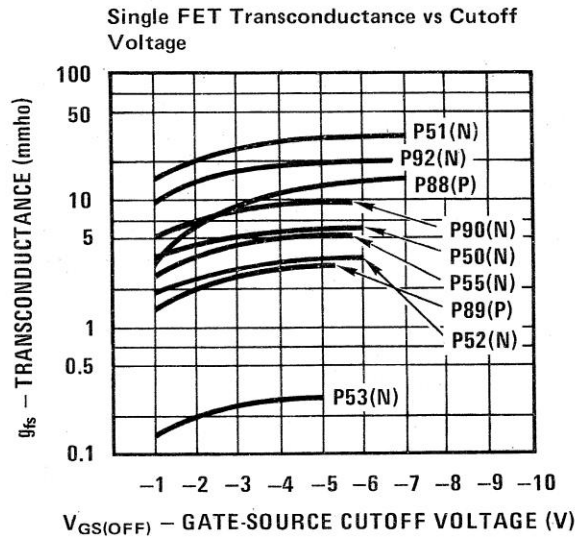
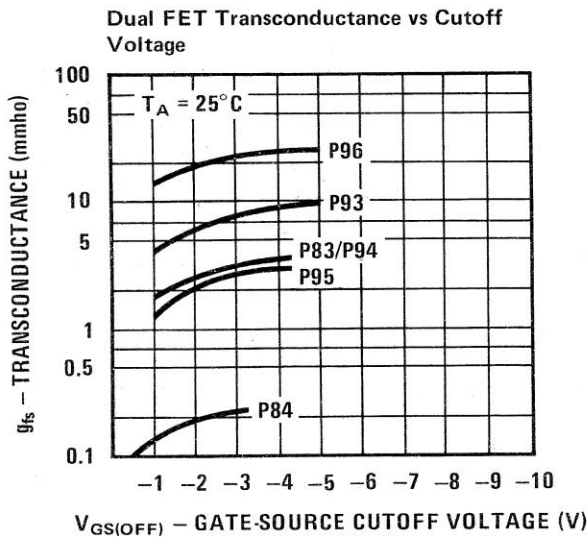
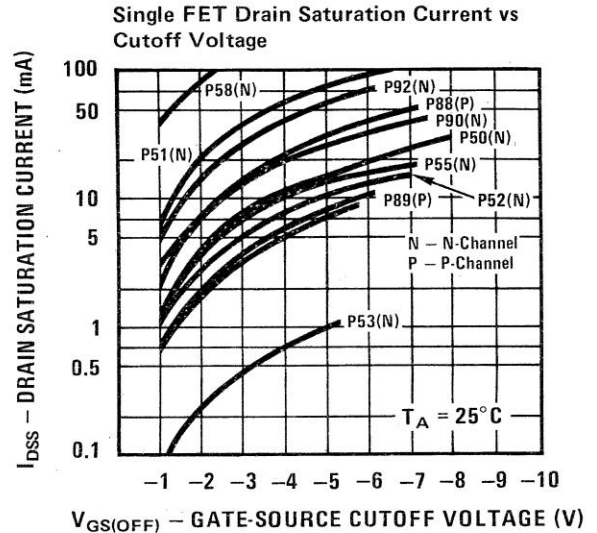
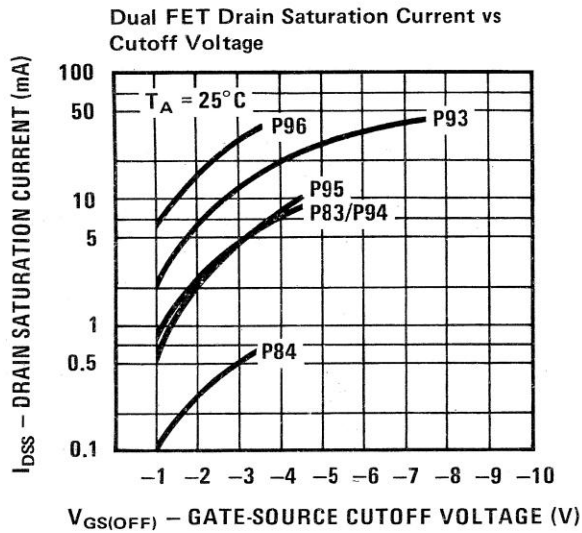

Figure 3. JFET Process Comparison Curves

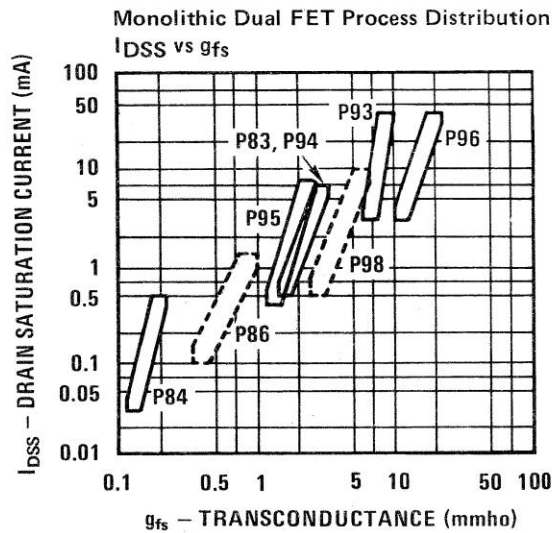
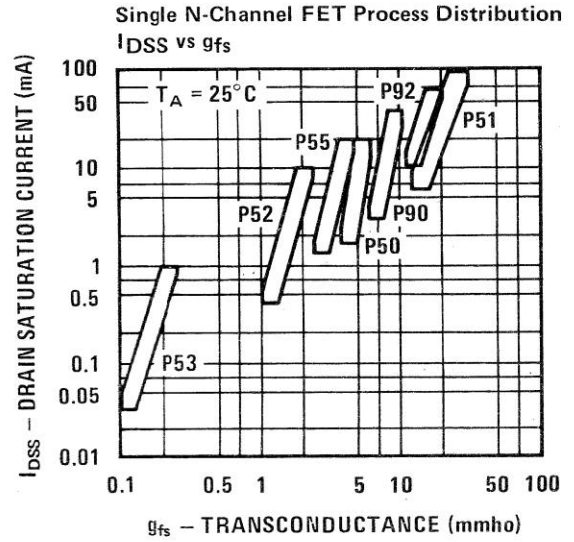
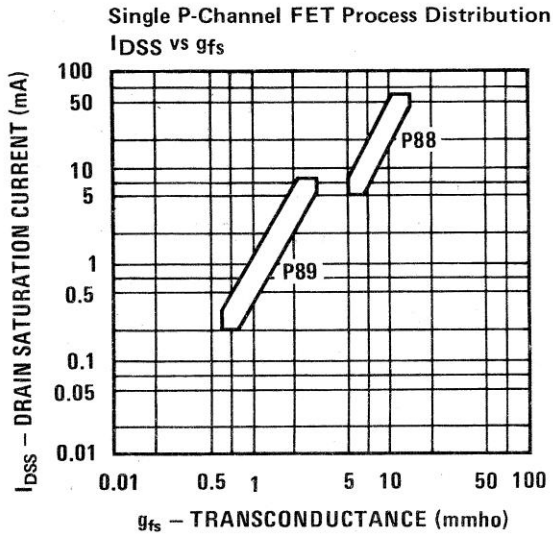
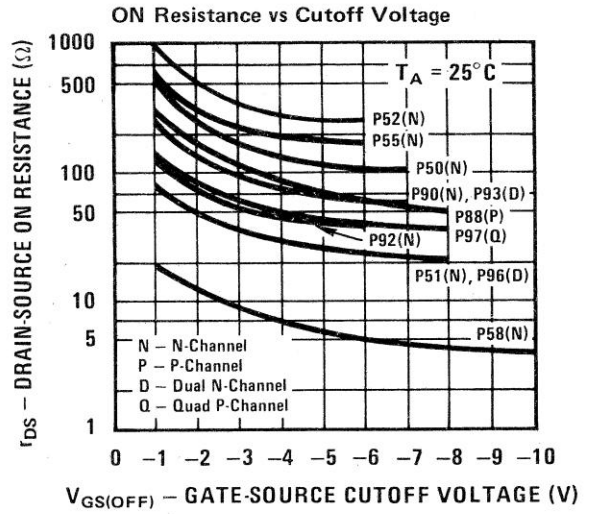
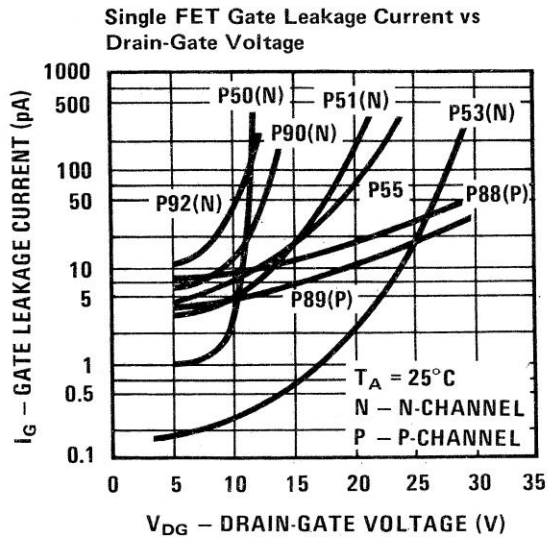

Figure 4. JFET Process Comparison Curves (Continued)

JFET Characteristic Selection Guide

Table 4. N-Channel Selection Guide: Switches and Choppers

Type No.	BV _{GSS} BV _{GDO}		I _{GSS} *I _{DGO}		I _{D(off)} *I _{DGO}		V _{GS} (V)	V _p			I _{DSS}		r _{ds(on)}		C _{iss}		V _{GS} (V)	C _{rss}		t _{on} (ns)	t _{off} (ns)	Process No.		
	(V) Min	@ I _G (μA)	(nA) Max	@ V _{DG} (V)	(nA) Max	@ V _{DG} (V)		Min	Max	@ V _{DS} (V)	I _D (nA)	Min	Max	@ V _{DS} (V)	(Ω) Max	@ I _D (mA)		(pF) Max	@ V _{DS} (V)				V _{GS} (V)	(pF) Max
2N3824	50	1	0.1	30	0.1	15	-8	4	8	15	1	2	20	250	6	15	0	3	0	-8		55		
2N3966	30	1	1	20	0.1	10	-7	4	6	10	10	2	20	220	6	20	0	1.5	0	-7		50		
2N3970	40	1	0.25*	20	0.25	20	-12	4	10	20	1	50	150	30	1	25	20	0	6	0	-12	20	30	51
2N3971	40	1	0.25*	20	0.25	20	12	2	5	20	1	25	75	60	1	25	20	0	6	0	-12	30	60	51
2N3972	40	1	0.25*	20	0.25	20	-12	0.5	3	20	1	5	30	100	1	25	20	0	6	0	-12	80	100	51
•2N4091	40	1	0.2*	20	0.2	20	-12	5	10	20	1	30	20	30	1	16	20	0	5	0	-20	25	40	51
•2N4092	40	1	0.2*	20	0.2	20	-8	2	7	20	1	15	20	50	1	16	20	0	5	0	-20	35	60	51
•2N4093	40	1	0.2*	20	0.2	20	-6	1	5	20	1	8	20	80	1	16	20	0	5	0	-20	60	80	51
2N4391	40	1	0.1	20	0.1	20	-12	4	10	20	1	50	150	30	1	14	20	0	3.5	0	-12	20	35	51
2N4392	40	1	0.1	20	0.1	20	-7	2	5	20	1	25	75	60	1	14	20	0	3.5	0	-7	20	55	51
2N4393	40	1	0.1	20	0.1	20	-5	0.5	3	20	1	5	30	100	1	14	20	0	3.5	0	-5	20	80	51
•2N4856	40	1	0.25	20	0.25	15	-10	4	10	15	.5	50	15	25	18	0	-10	8	0	-10	9	25	51	
2N4856A	40	1	0.25	20	0.25	15	-10	4	10	15	.5	50	15	25	10	0	-10	4	0	-10	8	20	51	
•2N4857	40	1	0.25	20	0.25	15	-10	2	6	15	.5	20	100	15	40	18	0	-10	8	0	-10	10	50	51
2N4857A	40	1	0.25	20	0.25	15	-10	2	6	15	.5	20	100	15	40	10	0	-10	3.5	0	-10	10	40	51
•2N4858	40	1	0.25	20	0.25	15	-10	0.8	4	15	.5	8	80	15	60	18	0	-10	8	0	-10	20	100	51
2N4858A	40	1	0.25	20	0.25	15	-10	0.8	4	15	.5	8	80	15	60	10	0	-10	3.5	0	-10	16	80	51
•2N4859	30	1	0.25	15	0.25	15	-10	4	10	15	.5	50	15	25	18	0	-10	8	0	-10	9	25	51	
2N4859A	30	1	0.25	15	0.25	15	-10	4	10	15	.5	50	15	25	10	0	-10	4	0	-10	8	20	51	
•2N4860	30	1	0.25	15	0.25	15	-10	2	6	15	.5	20	100	15	40	18	0	-10	8	0	-10	10	50	51
2N4860A	30	1	0.25	15	0.25	15	-10	2	6	15	.5	20	100	15	40	10	0	-10	3.5	0	-10	10	40	51
•2N4861	30	1	0.25	15	0.25	15	-10	0.8	4	15	.5	8	80	15	60	18	0	-10	8	0	-10	20	100	51
2N4861A	30	1	0.25	15	0.25	15	-10	0.8	4	15	.5	8	80	15	60	10	0	-10	3.5	0	-10	16	80	51
2N5432	25	1	0.2	15	0.2	5	-10	4	10	5	3	150	15	5	10	30	0	-10	15	0	-10	5	36	58
2N5433	25	1	0.2	15	0.2	5	-10	3	9	5	3	100	15	7	10	30	0	-10	15	0	-10	5	36	58
2N5434	25	1	0.2	15	0.2	5	-10	1	4	5	3	30	15	10	10	30	0	-10	15	0	-10	5	36	58
2N5555	25	10	1	15	10	12	-10	(10)				15	15	150	5	15	0	1.2	0	-10	10	25	50	

• Note. JAN qualified per applicable MIL-S-19500 specification.

Type No.	BV _{GSS} BV _{GDO}		I _{GSS} *I _{DGO}		I _{D(off)} *I _{DGO}		V _{GS} (V)	V _p			I _{DSS}		r _{ds(on)}		C _{iss}		V _{GS} (V)	C _{rss}		t _{on} (ns)	t _{off} (ns)	Process No.			
	(V) Min	@ I _G (μA)	(nA) Max	@ V _{DG} (V)	(nA) Max	@ V _{DG} (V)		Min	Max	@ V _{DS} (V)	I _D (nA)	Min	Max	@ V _{DS} (V)	(Ω) Max	@ I _D (mA)		(pF) Max	@ V _{DS} (V)				V _{GS} (V)	(pF) Max	@ V _{DS} (V)
2N5638	30	10	1	15	1	15	12	(12)				50	20	30	1	10	0	-12	4	0	-12		51		
2N5639	30	10	1	15	1	15	-8	(8)				25	20	60	1	10	0	-12	4	0	-8		51		
2N5640	30	10	1	15	1	15	-6	(6)				5	20	100	1	10	0	-12	4	0	-6		51		
2N5653	30	10	1	15	1	15	-12	(12)				40	20	50	1	10	0	-12	3.5	0	-12	9	15	51	
2N5654	25	10	1	15	10	15	-8	(8)				15	20	100	1	10	0	-12	3.5	0	-8	14	30	51	
J108	25	1	3	15	3	5	-10	3	10	5	1000	80	15	8	10	130	0	-10	115	0	-10	15	136	58	
J109	25	1	3	15	3	5	-10	2	6	5	1000	40	15	12	10	130	0	-10	115	0	-10	15	136	58	
J110	25	1	3	15	3	5	-10	.5	4	5	1000	10	15	18	10	130	0	-10	115	0	-10	15	136	58	
J111	35	1	1	15	1	5	-10	3	10	5	1000	20	15	30	1	110	0	-10	15	0	-10	113	135	51	
J112	35	1	1	15	1	5	-10	1	5	5	1000	5	15	50	1	110	0	-10	15	0	-10	113	135	51	
J113	35	1	1	15	1	5	-10	.5	3	5	1000	2	15	100	1	110	0	-10	15	0	-10	113	135	51	
J114	25	1	1	15	1	5	-10	3	10	5	1000	15	15	150	1	14	0	-10	12	0	-10	16	120	90	
PN4091	40	1	1*	20	1	20	-12	5	10	20	1	30	20	30		16	20	0	5	20	0	25	40	51	
PN4092	40	1	1*	20	1	20	-8	2	7	20	1	15	20	50		16	20	0	5	20	0	35	60	51	
PN4093	40	1	1*	20	1	20	-6	1	5	20	1	8	20	80		16	20	0	5	20	0	60	80	51	
PN4391	40	1	1	20	1	20	-12	4	10	20	1	50	150	30		14	20	0	3.5	0	-12	20	35	51	
PN4392	40	1	1	20	1	20	-7	2	5	20	1	25	75	60		14	20	0	3.5	0	-7	40	80	51	
PN4393	40	1	1	20	1	20	-5	0.5	3	20	1	5	30	20	100		14	20	0	3.5	0	-5	55	130	51
PN4856	40	1	1	20	1	15	-10	4	10	15	.5	50	15	25		18	0	-10	8	0	-10	9	25	51	
PN4857	40	1	1	20	1	15	-10	2	6	15	.5	20	100	15	40		18	0	-10	8	0	-10	10	50	51
PN4858	40	1	1	20	1	15	-10	0.8	4	15	.5	8	80	15	60		18	0	-10	8	0	-10	20	100	51
PN4859	30	1	1	15	1	15	-10	4	10	15	.5	50	15	25		18	0	-10	8	0	-10	9	25	51	
PN4860	30	1	1	15	1	15	-10	2	6	15	.5	20	100	15	40		18	0	-10	8	0	-10	10	50	51
PN4861	30	1	1	15	1	15	-10	0.8	4	15	.5	8	80	15	60		18	0	-10	8	0	-10	20	100	51
T1S73	30	1	2	15	2	15	-10	4	10	15	4	50	15	25		18	0	-10	8	0	-10	9	25	51	
T1S74	30	1	2	15	2	15	-10	2	6	15	4	20	100	15	40		18	0	-10	8	0	-10	10	50	51
T1S75	30	1	2	15	2	15	-10	0.8	4	15	4	8	80	15	60		18	0	-10	8	0	-10	20	100	51
U1897E	40	1	0.2*	20				5	10	20	1	30	20	30	1	16	20	0	5	0	-20	25	40	51	
U1898E	40	1	0.2*	20				2	7	20	1	15	20	50	1	16	20	0	5	0	-20	35	60	51	
U1899E	40	1	0.2*	20				1	5	20	1	8	20	80	1	16	20	0	5	0	-20	60	80	51	

Table 5. N-Channel Selection Guide: RF, VHF, UHF Amplifiers

Type No.	BV _{GSS} BV _{GDO}		I _{GSS} I _{DGO}		V _p @ V _{DS}			I _{DSS} @ V _{DS}		R _e Y _{f_s}		R _e (Y _{os})		C _{iss}		V _{GS}	C _{r_{ss}}		V _{GS}	NF		Process No.		
	(V) @ I _G Min (μA)	I _G	(pA) @ V _{DG} Max (V)	V _p Min	Max	(V)	I _D (nA)	Min	Max	(V)	(mmho) @ Freq Min (MHz)	Max (MHz)	(μmho) @ f Max (MHz)	(pF) @ V _{DS} Max (V)	V _{GS}		(V)	(pF) @ V _{DS} Max (V)		V _{GS}	(V)		(dB) @ R _G = 1k Max (MHz)	Freq Max (MHz)
2N3819	25	1	2	15	8	15	2	2	20	15	1.6	100		8	15	0	4	15	0			50		
2N3823	30	1	0.5	20	8	15	.5	4	20	15	3.2	200	200	200	200	6	15	0	2	15	0	2.5	100	50
2N4223	30	10	0.25	20	0.1	8	15	.25	3	18	15	2.7	200	200	200	6	15	0	2	15	0	5	200	50
2N4224	30	10	0.5	20	0.1	8	15	.5	2	20	15	1.7	200	200	200	6	15	0	2	15	0			50
2N4416	30	1	0.1	20	6	15	1	5	15	15	4	400	100	400	4	15	0	0.8	15	0	4	400	50	
2N4416A	35	1	0.1	20	2.5	6	15	1	5	15	15	4	400	100	400	4	15	0	0.8	15	0	4	400	50
2N5078	30	1	0.25	20	0.5	8	15		4	25	15	4	200	150	200	6	15	0	2	15	0	3	200	50
2N5245	30	1	1	20	1	6	15	10	5	15	15	4	400	100	400	4.5	15	0	1	15	0	4	400	90
2N5246	30	1	1	20	0.5	4	15	10	1.5	7	15	2.5	400	100	400	4.5	15	0	1	15	0			90
2N5247	30	1	1	20	1.5	8	15	10	8	24	15	4	400	150	400	4.5	15	0	1	15	0			90
2N5248	30	1	5	20	1	8	15	10	4	20	15	3	200	200	200	6	15	0	2	15	0			50
2N5397	25	1	0.1	15	1	6	10	1	10	30	10	5.5	450	200	450	5	10	10m	1.2	10	10m	3.5	450	90
2N5398	25	1	0.1	15	1	6	10	1	5	40	10	5.0	450	400	450	5.5	10	0	1.3	10	0	3.2	450	90
2N5484	25	1	1	20	0.3	3	15	10	1	5	15	2.5	100	75	100	5	15	0	1	15	0	3	100	50
2N5485	25	1	1	20	1	4	15	10	4	10	15	3	400	100	400	5	15	0	1	15	0	4	400	50
2N5486	25	1	1	20	2	6	15	10	8	20	15	3.5	400	100	400	5	15	0	1	15	0	4	400	50
2N5668	25	10	2	15	0.2	4	15	10	1	5	15	1	100	50	100	7	15	0	3	15	0	2.5	100	50
2N5669	25	10	2	15	1	6	15	10	4	10	15	1.6	100	100	100	7	15	0	3	15	0	2.5	100	50
2N5670	25	10	2	15	2	8	15	10	8	20	15	2.5	100	150	100	7	15	0	3	15	0	2.5	100	50
2N5949	30	1	1	15	3	7	15	100	12	18	15	3.0	100	75	100	6	15	0	2	15	0	5	100	50
2N5950	30	1	1	15	2.5	6	15	100	10	15	15	3.0	100	75	100	6	15	0	2	15	0	5	100	50
2N5951	30	1	1	15	2	5	15	100	7	13	15	3.0	100	75	100	6	15	0	2	15	0	5	100	50
2N5952	30	1	1	15	1.3	3.5	15	100	4	8	15	1.0	100	75	100	6	15	0	2	15	0	5	100	50
2N5953	30	1	1	15	.8	3	15	100	2.5	5	15	1.0	100	50	100	6	15	0	2	15	0	5	100	50
J300	25	1	0.5	15	1	6	10	1	6	30	10	4.5	.001	200	.001	5.5	10	5m	1.7	10	5m	t2	100	90
J304	30	1	0.1	20	2	6	15	1	5	15	15	t4.2	400	t80	100	t3	15	0	t.8	15	0	t4	400	50
J305	30	1	0.1	20	.5	3	15	1	1	8	15	t3.0	400	t80	100	t3	15	0	t.8	15	0	t4	400	50
J308	25	1	1	15	1	6.5	10	1	12	60	10	8	.001	200	.001	7.5	0	-10	2.5	0	-10	t1.5	100	92
J309	25	1	1	15	1	4.0	10	1	12	30	10	10	.001	200	.001	7.5	0	-10	2.5	0	-10	t1.5	100	92
J310	25	1	1	15	2	6.5	10	1	24	60	10	8	.001	200	.001	7.5	0	-10	2.5	0	-10	t1.5	100	92

• Note. JAN qualified per applicable MIL-S-19500 specification.

Type No.	BV _{GSS} BV _{GDO}		I _{GSS} I _{DGO}		V _p @ V _{DS}			I _{DSS} @ V _{DS}		R _e Y _{f_s}		R _e (Y _{os})		C _{iss}		V _{GS}	C _{r_{ss}}		V _{GS}	NF		Process No.		
	(V) @ I _G Min (μA)	I _G	(pA) @ V _{DG} Max (V)	V _p Min	Max	(V)	I _D (nA)	Min	Max	(V)	(mMho) @ Freq Min (MHz)	Max (MHz)	(μMho) @ f Max (MHz)	(pF) @ V _{DS} Max (V)	V _{GS}		(V)	(pF) @ V _{DS} Max (V)		V _{GS}	(V)		(dB) @ R _G = 1k Max (MHz)	Freq Max (MHz)
MPF102	25	1	2	15	8	15	2	2	20	15	1.6	100	100	200	7	15	0	3	15	0			50	
MPF106	25	1	1	20	0.5	4	15	.5	4	10	15	2.5	0.001		5	15	0	2	15	0	4	400	50	
MPF107	25	1	1	20	2	6	15	.5	8	20	15	4	0.001		5	15	0	1.2	15	0	4	400	50	
MPF108	25	10	1	15	0.5	8	15	10μ	1.5	24	15	1.6	100	200	100	6.5	15	0	2.5	15	0	3	100	50
PN4223	30	1	0.25	20	0.1	8	15	1	3	18	15	2.7	200	200	200	6	15	0	2	15	0	5	200	50
PN4224	30	1	0.25	20	0.1	8	15	5	2	20	15	1.7	200	200	200	6	15	0	2	15	0			50
PN4416	30	1	0.1	20	6	15	1	5	15	15	4	400	100	400	4	15	0	0.8	15	0	4	400	50	
U308	25	1	0.15	15	1	6	10	1	12	60	10	10	0.001	150	100	5	0	10m	2.5	0	10mA	t3	450	92
U309	25	1	0.15	15	1	4	10	1	12	30	10	10	0.001	150	100	5	0	10m	2.5	0	10mA	t3	450	92
U310	25	1	0.15	15	2.5	6	10	1	24	60	10	10	0.001	150	100	5	10	10m	2.5	10	10mA	t3	450	92
U312	25	1	0.1	15	1	6	10	1	10	30	10	6	0.001		3.8	10	10m	1.2	10	10mA	t3.5	450	90	
U320	20	1	3	15	2	10	5	1m	100	500	15	75	0.001		30	0	10	15	0	10	t2.5	30	58	
U321	25	1	3	15	1	4	5	1m	80	250	15	75	0.001		30	0	10	15	0	10	t2.5	30	58	
U322	25	1	3	15	3	10	5	1m	200	700	15	75	0.001		30	0	10	15	0	10	t2.5	30	58	

Table 6. N-Channel Selection Guide: Low Frequency – Low Noise Amplifiers

Type No.	BV _{GSS} (V) @ I _G		I _{GSS} (nA) @ V _{DG}		V _{GS(OFF)} (V) @ V _{DS}			I _{DSS} (mA) @ V _{DS}			g _{f5} (Re Y _{f5}) (mmho) @ V _{DS}		f (MHz)	G _{oss} (μmho) @ V _{DS}		C _{iss} (pF) @ V _{DS}		V _{GS} (V)	C _{rss} (pF) @ V _{DS}		nV/√Hz @ f	Process No.			
	Min	Max	Max	Max	Min	Max	I _D (nA)	Min	Max	Max	Min	Max		Max	Max	Max	Max		Max	Max			Max	Max	
2N4393	40	1.0	0.1	20	0.5	3.0	20	1.0	5.0	30	20	t12	20	0.001			14	20	0	3.5	5.0(GS)	t8.0	10	51	
2N5556	30	10	0.1	15	0.2	4.0	15	1.0	0.5	2.5	15	1.5	6.5	15	0.001	20	15	6.0	15	0	3.0	15	35	10	50
2N5557	30	10	0.1	15	0.8	5.0	15	1.0	2.0	5.0	15	1.5	6.5	15	0.001	20	15	6.0	15	0	3.0	15	35	10	50
2N5558	30	10	0.1	15	1.5	6.0	15	1.0	4.0	10	15	1.5	6.5	15	0.001	20	15	6.0	15	0	3.0	15	35	10	50
NF5101	40	1	0.2	15	0.5	1.1	15	1.0	1.0	12	15	3.5	15	0.001	25	15	t12	15	0	t4	15	3.5	1k	51	
NF5102	40	1	0.2	15	0.7	1.6	15	1.0	4.0	20	15	7.5	15	0.001	25	15	t12	15	0	t4	15	3.5	1k	51	
NF5103	40	1	0.2	15	1.2	2.7	15	1.0	10	40	15	7.5	15	0.001	25	15	t12	15	0	t4	15	3.5	1k	51	
PF5101	40	1	0.2	15	0.5	1.1	15	1.0	1.0	12	15	3.5	15	0.001	25	15	t12	15	0	t4	15	3.5	1k	51	
PF5102	40	1	0.2	15	0.7	1.6	15	1.0	4.0	20	15	7.5	15	0.001	25	15	t12	15	0	t4	15	3.5	1k	51	
PF5103	40	1	0.2	15	1.2	2.7	15	1.0	10	40	15	7.5	15	0.001	25	15	t12	15	0	t4	15	3.5	1k	51	
PN4393	40	1.0	0.1	20	0.5	3.0	20	1.0	5.0	30	20	t12	20	0.001			14	20	0	3.5	5.0(GS)	t8.0	10	51	

Table 7. N-Channel Selection Guide: Ultra Low Current Amplifiers

Transistor Type	BV _{GSS} BV _{GDO} (V) @ I _G		I _{GSS} I _{DGO} (pA) @ V _{DG}		V _p (V) @ V _{DS}			I _{DSS} (μA) @ V _{DS}			G _{f5} (μmho) @ V _{DS}			G _{oss} (μmho) @ V _{DS}		C _{iss} (pF) @ V _{DS}		V _{GS} (V)	C _{rss} (pF) @ V _{DS}		V _{GS} (V)	$\left(\frac{nV}{\sqrt{Hz}}\right)_{Max}$ @ f	Process No.	
	Min	Max	Max	Max	Min	Max	I _D (nA)	Min	Max	Max	Min	Max	Max	Max	Max	Max	Max		Max	Max				
2N4117	40	1	10	20	0.6	1.8	10	1	30	90	10	20	210	10	3	10	3	10	0	1.5	10	0		53
2N4117A	40	1	1	20	0.6	1.8	10	1	30	90	10	70	210	10	3	10	3	10	0	1.5	10	0		53
2N4118	40	1	10	20	1	3	10	1	80	240	10	80	250	10	5	10	3	10	0	1.5	10	0		53
2N4118A	40	1	1	20	1	3	10	1	80	240	10	80	250	10	5	10	3	10	0	1.5	10	0		53
2N4119	40	1	10	20	2	6	10	1	200	600	10	100	330	10	10	10	3	10	0	1.5	10	0		53
2N4119A	40	1	1	20	2	6	10	1	200	600	10	100	330	10	10	10	3	10	0	1.5	10	0		53

Table 8. N-Channel Selection Guide: General Purpose Amplifiers

Transistor Type	BV _{GSS} *BV _{GDO} (V) @ I _G		I _{GSS} I _{DGO} (nA) @ V _{DG}		V _p @ V _{DS} (V) I _D (nA)			I _{DSS} @ V _{DS} (mA) (V)			G _{fs} @ V _{DS} (mmho) (V)			G _{oss} @ V _{DS} (μmho) (V)		C _{iss} @ V _{DS} (pF) (V)		V _{GS} (V)	C _{rss} @ V _{DS} (pF) (V)		V _{GS} (V)	(NV/√Hz) ^{en} @ Freq (Hz)	Process No.		
	Min	Max	Min	Max	Min	Max	Max	Min	Max	Max	Min	Max	Max	Max	Max	Max	Max								
2N3069	*50	1	1	30	9.5	30	1000	2	10	30	1	2.5	30	80	30	15	0	-12	1.5	30	0	125	1000	52	
2N3070	*50	1	1	30	4.5	30	1000	0.5	2.5	30	0.75	2.5	30	30	30	15	0	-8	1.5	30	0	125	1000	52	
2N3368	*40	1	5	30	11.5	20	1000	2	12	30	1	4	30	80	30	20	8	0	3	30	0			52	
2N3369	*40	1	5	30	6.5	20	1000	0.5	2.5	30	0.6	2.5	30	30	30	20	8	0	3	30	0			52	
2N3370	*40	1	5	30	3.2	20	1000	0.1	0.6	30	0.3	2.5	30	15	30	20	8	0	3	30	0			52	
2N3436	*50	1	0.5	30	9.8	20	1000	3	15	20	2.5	10	20	35	30	18	0	-10	6	30	0	100	1000	55	
2N3437	*50	1	0.5	30	4.8	20	1000	0.8	4	20	1.5	6	20	20	30	18	0	-6	6	30	0	100	1000	55	
2N3438	*50	1	0.5	30	2.3	20	1000	0.2	1	20	0.8	4.5	20	5	30	18	0	-4	6	30	0	100	1000	55	
2N3458	*50	1	0.25	30	7.8	20	1000	3	15	20	2.5	10	20	35	30	18	0	-10	5	30	0	225	20	52	
2N3459	*50	1	0.25	30	3.4	20	1000	0.8	4	20	1.5	6	20	20	30	18	0	-6	5	30	0	155	20	52	
2N3460	*50	1	0.25	30	1.8	20	1000	0.2	1	20	0.8	4.5	20	5	30	18	0	-4	5	30	0	155	20	52	
2N3684	50	1	0.1	30	2	5	20	1	2.5	7.5	20	2	3	20	50	20	4	20	0	1.2	20	0	150	100	52
2N3685	50	1	0.1	30	1	3.5	20	1	1	3	20	1.5	2.5	20	25	20	4	20	0	1.2	20	0	150	100	52
2N3686	50	1	0.1	30	0.6	2	20	1	0.4	1.2	20	1	2	20	10	20	4	20	0	1.2	20	0	150	100	52
2N3687	50	1	0.1	30	0.3	1.2	20	1	0.1	0.5	20	0.5	1.5	20	5	20	4	20	0	1.2	20	0	150	100	52
2N3821	50	1	0.1	30	4	15	.5	0.5	2.5	15	1.5	4.5	15	10	15	6	15	0	3	15	0	200	10	55	
2N3822	50	1	0.1	30	6	15	.5	2	10	15	3	6.5	15	20	15	6	15	0	3	15	0	200	10	55	
2N3967	30	1	0.1	20	2	5	20	1	2.5	10	20	2.5	20	35	20	5	20	†	1.3	20	‡	84	100	50	
2N3967A	30	1	0.1	20	2	5	20	1	2.5	10	20	2.5	20	35	20	5	20	†	1.3	20	‡	160	10	50	
2N3968	30	1	0.1	20	3	20	1	1	5	20	2		20	15	20**	5	20	**	1.3	20	†	84	100	50	
2N3968A	30	1	0.1	20	3	20	1	1	5	20	2		20	15	20**	5	20	**	1.3	20	†	160	10	50	
2N3969	30	1	0.1	20	1.7	20	1	0.4	2	20	1.3		20	5	20††	5	20	††	1.3	20	‡	84	100	50	
2N3969A	30	1	0.1	20	1.7	20	1	0.4	2	20	1.3		20	5	20††	5	20	††	1.3	20	‡	160	10	50	

‡ I_D = 1 mA † I_D = 500 μA †† I_D = 250 μA δ I_D = 100 μA ** I_D = 100 μA ††† I_D = 40 μA

Transistor Type	BV _{GSS} *BV _{GDO} (V) @ I _G		I _{GSS} I _{DGO} (nA) @ V _{DG}		V _p @ V _{DS} (V) I _D (nA)			I _{DSS} @ V _{DS} (mA) (V)			G _{fs} @ V _{DS} (mmho) (V)			G _{oss} @ V _{DS} (μmho) (V)		C _{iss} @ V _{DS} (pF) (V)		V _{GS} (V)	C _{rss} @ V _{DS} (pF) (V)		V _{GS} (V)	(NV/√Hz) ^{en} @ Freq (Hz)	Process No.		
	Min	Max	Min	Max	Min	Max	Max	Min	Max	Max	Min	Max	Max	Max	Max	Max									
2N4220	30	10	0.1	15	4	15	.1	0.5	3	15	1	4	15	10	15	6	15	0	2	15	0			55	
2N4220A	30	10	0.1	15	4	15	.1	0.5	3	15	1	4	15	10	15	6	15	0	2	15	0	115	100	55	
2N4221	30	10	0.1	15	6	15	.1	2	6	15	2	5	15	20	15	6	15	0	2	15	0			55	
2N4221A	30	10	0.1	15	6	15	.1	2	6	15	2	5	15	20	15	6	15	0	2	15	0	115	100	55	
2N4222	30	10	0.1	15	8	15	.1	5	15	15	2.5	6	15	40	15	6	15	0	2	15	0			55	
2N4222A	30	10	0.1	15	8	15	.1	5	15	15	2.5	6	15	40	15	6	15	0	2	15	0	115	100	55	
2N4338	50	1	0.1	30	0.3	1	15	100	0.2	0.6	15	0.6	1.8	15	5	15	7	15	0	3	15	0	68	1000	52
2N4339	50	1	0.1	30	0.6	1.8	15	100	0.5	1.5	15	0.8	2.4	15	15	15	7	15	0	3	15	0	68	1000	52
2N4340	50	1	0.1	30	1	3	15	100	1.2	3.6	15	1.3	3	15	30	15	7	15	0	3	15	0	68	1000	52
2N4341	50	1	0.1	30	2	6	15	100	3	9	15	2	4	15	60	15	7	15	0	3	15	0	68	1000	55
2N5103	25	10	0.1	15	0.5	4	15	1	1	8	15	2	8	15	100	15	5	15	0	1	15	0	100	10	50
2N5104	25	1	0.1	15	0.5	4	15	1	2	6	15	3.5	7.5	15	100	15	5	15	0	1	15	0	50	10	50
2N5105	25	1	0.1	15	0.5	4	15	1	5	15	15	5	10	15	100	15	5	15	0	1	15	0			50
2N5358	40	1	0.1	20	0.5	3	15	100	0.5	1	15	1	3	15	10	15	6	15	0	2	15	0	115	100	55
2N5359	40	1	0.1	20	0.8	4	15	100	0.6	1.6	15	1.2	3.6	15	10	15	6	15	0	2	15	0	115	100	55
2N5360	40	1	0.1	20	0.8	4	15	100	0.5	2.5	15	1.4	4.2	15	20	15	6	15	0	2	15	0	115	100	55
2N5361	40	1	0.1	20	1	6	15	100	2.5	5	15	1.5	4.5	15	20	15	6	15	0	2	15	0	115	100	55
2N5362	40	1	0.1	20	2	7	15	100	4	8	15	2	5.5	15	40	15	6	15	0	2	15	0	115	100	55
2N5363	40	1	0.1	20	2.5	8	15	100	7	14	15	2.5	6	15	40	15	6	15	0	2	15	0	115	100	55
2N5364	40	1	0.1	20	2.5	8	15	100	9	18	15	2.7	6.5	15	60	15	6	15	0	2	15	0	115	100	55
2N5457	25	1	1	15	0.5	6	15	10	1	5	15	2	5	15	50	15	7	15	0	3	15	0			55
2N5458	25	1	1	15	1	7	15	10	2	9	15	1.5	5.5	15	50	15	7	15	0	3	15	0			55
2N5459	25	1	1	15	2	8	15	10	4	16	15	2	6	15	50	15	7	15	0	3	15	0			55
2N5556	30	1	0.1	15	0.2	4	15	1	0.5	2.5	15	1.5	6.5	15	20	15	6	15	0	3	15	0	35	10	50
2N5557	30	1	0.1	15	0.8	5	15	1	2.0	5.0	15	1.5	6.5	15	20	15	6	15	0	3	15	0	35	10	50
2N5558	30	1	0.1	15	1.5	6	15	1	4	10	15	1.5	6.5	15	20	15	6	15	0	3	15	0	35	10	50
J201	40	1	0.1	20	0.3	1.5	20	10	0.2	1.0	20	0.5		20	†1	20	†5	20	0	†2	20	0	†10	1k	52
J202	40	1	0.1	20	0.8	4.0	20	10	0.9	4.5	20	1.0		20	†3.5	20	†5	20	0	†2	20	0	†10	1k	52
J203	40	1	0.1	20	2.0	10.0	20	10	4.0	20	20	1.5		20	†10	20	†5	20	0	†2	20	0	†10	1k	52
J210	25	1	0.1	15	1	3	15	1	2	15	15	4.0	12.0	15	150	15	†5	15	0	†1.5	15	0	†10	1k	90
J211	25	1	0.1	15	2.5	4.5	15	1	7	20	15	7.0	12.0	15	200	15	†5	15	0	†1.5	15	0	†10	1k	90
J212	25	1	0.1	15	4	6	15	1	15	40	15	7.0	12.0	15	200	15	†5	15	0	†1.5	15	0	†10	1k	90
MPF103	25	1	1	15	6	15	1	1	5	15	1	5	15	50	15	7	15	0	3	15	0			55	
MPF104	25	1	1	15	7	15	1	2	9	15	1.5	5.5	15	50	15	7	15	0	3	15	0			55	
MPF105	25	1	1	15	8	15	1	4	16	15	2	6	15	50	15	7	15	0	3	15	0			55	
MPF109	25	10	1	15	0.2	8	15	10	0.5	24	15	0.8	6	15	75	15	7	15	0	3	15	0	115	1000	55

Table 10. N-Channel Selection Guide: Low Frequency – Low Noise Dual JFETs

Type No.	OPERATING CONDITIONS FOR THESE CHARACTERISTICS										V _p (V)	I _{DSS} (mA)	G _f (μmho)	G _{oss} (μmho)	I _{GSS} (pA) @ V _{DG} (V)	C _{iss} (pF)	C _{rss} (pF)	BV (V)	e _n (nV/√Hz) @ f (Hz)	I _{DSS} Match %	G _f Match %	G _{oss} 1-2 (μmho)	I _{G1} -I _{G2} 125°C (nA)	Process No.						
	OP. CHAR. V _{DG} (V)	I _D (μA)	V _{GS1-2} V _{OS} (mV) Max	DRIFT (μV/°C) ΔV _{GS} Max	I _G (pA) Max	G _f μmhos Min Max	G _{oss} (μmho) Max	CMRR (dB) Min	V _{GS} (V) Min Max	Min															Max	Min	Max	Min	Max	Min
2N5515	20	200	5.0	5.0	100	500	1000	1.0	100	0.2	3.8	0.7	4.0	0.5	7.5	1.0	4.0	10	250	30	+25	+5.0	40	30	10	5.0	3.0	0.1	10	95
2N5516	20	200	5.0	10	100	500	1000	1.0	100	0.2	3.8	0.7	4.0	0.5	7.5	1.0	4.0	10	250	30	+25	+5.0	40	10	10	5.0	3.0	0.1	10	95
2N5517	20	200	10	20	100	500	1000	1.0	90	0.2	3.8	0.7	4.0	0.5	7.5	1.0	4.0	10	250	30	+25	+5.0	40	10	10	5.0	5.0	0.1	10	95
2N5518	20	200	15	40	100	500	1000	1.0		0.2	3.8	0.7	4.0	0.5	7.5	1.0	4.0	10	250	30	+25	+5.0	40	10	10	5.0	5.0	0.1	10	95
2N5519	20	200	15	80	100	500	1000	1.0		0.2	3.8	0.7	4.0	0.5	7.5	1.0	4.0	10	250	30	+25	+5.0	40	10	10	5.0	10	0.1	10	95
2N5520	20	200	5.0	5.0	100	500	1000	1.0	100	0.2	3.8	0.7	4.0	0.5	7.5	1.0	4.0	10	250	30	+25	+5.0	40	15	10	5.0	3.0	0.1	10	95
2N5521	20	200	5.0	10	100	500	1000	1.0	100	0.2	3.8	0.7	4.0	0.5	7.5	1.0	4.0	10	250	30	+25	+5.0	40	10	10	5.0	3.0	0.1	10	95
2N5522	20	200	10	20	100	500	1000	1.0	90	0.2	3.8	0.7	4.0	0.5	7.5	1.0	4.0	10	250	30	+25	+5.0	40	10	10	5.0	5.0	0.1	10	95
2N5523	20	200	15	40	100	500	1000	1.0		0.2	3.8	0.7	4.0	0.5	7.5	1.0	4.0	10	250	30	+25	+5.0	40	10	10	5.0	5.0	0.1	10	95
2N5524	20	200	15	80	100	500	1000	1.0		0.2	3.8	0.7	4.0	0.5	7.5	1.0	4.0	10	250	30	+25	+5.0	40	10	10	5.0	10	0.1	10	95
2N6483	20	200	5.0	5.0	100	500	1500	1.0	100	0.2	3.8	0.7	4.0	0.5	7.5	1.0	4.0	10	200	30	20	3.5	50	10	10	5.0	3.0	0.1	10	95
2N6484	20	200	10	10	100	500	1500	1.0	100	0.2	3.8	0.7	4.0	0.5	7.5	1.0	4.0	10	200	30	20	3.5	50	10	10	5.0	3.0	0.1	10	95
2N6485	20	200	15	25	100	500	1500	1.0	90	0.2	3.8	0.7	4.0	0.5	7.5	1.0	4.0	10	200	30	20	3.5	50	10	10	5.0	5.0	0.1	10	95

Table 11. N-Channel Selection Guide: Wide Band – Low Noise Dual JFETs

Type No.	OPERATING CONDITIONS FOR THESE CHARACTERISTICS										V _p (V)	I _{DSS} (mA)	G _f (μmho)	G _{oss} (μmho)	I _{GSS} (pA) @ V _{DG} (V)	C _{iss} (pF)	C _{rss} (pF)	BV (V)	e _n (nV/√Hz) @ f (Hz)	I _{DSS} Match %	G _f Match %	G _{oss} 1-2 (μmho)	I _{G1} -I _{G2} 125°C (nA)	Process No.						
	OP. CHAR. V _{DG} (V)	I _D (μA)	V _{GS1-2} V _{OS} (mV) Max	DRIFT (μV/°C) ΔV _{GS} Max	I _G (pA) Max	G _f μmhos Min Max	G _{oss} (μmho) Max	CMRR (dB) Min	V _{GS} (V) Min Max	Min															Max	Min	Max	Min	Max	Min
2N5564	15	2000	5.0	10		7500		45				0.5	3.0	5.0	30			100	20	12	3.0	40	50	10	5.0	5.0			96	
2N5565	15	2000	10	25		7500		45				0.5	3.0	5.0	30			100	20	12	3.0	40	50	10	5.0	10			96	
2N5566	15	2000	20	50		7500		45				0.5	3.0	5.0	30			100	20	12	3.0	40	50	10	5.0	16			96	
2N5911	10	5000	10	20	100	5000	10,000	100		0.3	4.0	1.0	5.0	7.0	40			100	15	5.0	1.2	25	20	10k	5.0	5.0	20	20	93	
2N5912	10	5000	15	40	100	5000	10,000	100		0.3	4.0	1.0	5.0	7.0	40			100	15	5.0	1.2	25	20	10k	5.0	5.0	20	20	93	
NP05564	15	2000	5.0	10		7500		45				0.5	3.0	5.0	30			100	20	12	3.0	40	50	10	5.0	5.0			96	
NP05565	15	2000	10	25		7500		45				0.5	3.0	5.0	30			100	20	12	3.0	40	50	10	5.0	10			96	
NP05566	15	2000	20	50		7500		45				0.5	3.0	5.0	30			100	20	12	3.0	40	50	10	5.0	10			96	
U257	10	5000	100			5000	10,000	150				1.0	5.0	5.0	40			100	15	5.0	1.2	25	30	10k	15	15	20		93	
U430	10	10,000				10,000	20,000	150				1.0	4.0	12	30			150	15			25	10	100	10	10			92	
U431	10	10,000				10,000	20,000	150				2.0	6.0	24	60			150	15			25	10	100	10	10				

Table 12. N-Channel Selection Guide: Low Leakage – High CMRR Wide Band Dual JFETs

Type No.	OPERATING CONDITIONS FOR THESE CHARACTERISTICS										V _p (V)	I _{DSS} (mA)	G _f (μmho)	G _{oss} (μmho)	I _{GSS} (pA) @ V _{DG} (V)	C _{iss} (pF)	C _{rss} (pF)	BV (V)	e _n (nV/√Hz) @ f (Hz)	I _{DSS} Match %	G _f Match %	G _{oss} 1-2 (μmho)	I _{G1} -I _{G2} 125°C (nA)	Process No.					
	OP. CHAR. V _{DG} (V)	I _D (μA)	V _{GS1-2} V _{OS} (mV) Max	DRIFT (μV/°C) ΔV _{GS} Max	I _G (pA) Max	G _f μmhos Min Max	G _{oss} (μmho) Max	CMRR (dB) Min	V _{GS} (V) Min Max	Min															Max	Min	Max	Min	Max
NDF9401	20	200	5.0	5.0	5.0	950	2000	0.1	120	0.1	4.0	0.5	4.0	0.5	10			10	30	5.0	0.02	50	30	10	5.0	3.0	0.1	1.0	94
NDF9402	20	200	5.0	10	5.0	950	2000	0.1	120	0.1	4.0	0.5	4.0	0.5	10			10	30	5.0	0.02	50	30	10	5.0	3.0	0.1		94
NDF9403	20	200	10	10	5.0	950	2000	0.1	110	0.1	4.0	0.5	4.0	0.5	10			10	30	5.0	0.02	50	30	10	5.0	5.0	0.1	1.0	94
NDF9404	20	200	15	10	5.0	950	2000	0.1	110	0.1	4.0	0.5	4.0	0.5	10			10	30	5.0	0.02	50	30	10	5.0	5.0	0.1	1.0	94
NDF9405	20	200	25	25	5.0	950	2000	0.1	100	0.1	4.0	0.5	4.0	0.5	10			10	30	5.0	0.02	50	30	10	10	10	0.1	1.0	94
NDF9406	20	200	5.0	5.0	5.0	950	2000	0.1	120	0.1	4.0	0.5	4.0	0.5	10			10	30	5.0	0.02	50	30	10	5.0	3.0	0.1	1.0	94
NDF9407	20	200	5.0	10	5.0	950	2000	0.1	120	0.1	4.0	0.5	4.0	0.5	10			10	30	5.0	0.02	50	30	10	5.0	3.0	0.1	1.0	94
NDF9408	20	200	10	10	5.0	950	2000	0.1	110	0.1	4.0	0.5	4.0	0.5	10			10	30	5.0	0.02	50	30	10	5.0	5.0	0.1	1.0	94
NDF9409	20	200	15	10	5.0	950	2000	0.1	110	0.1	4.0	0.5	4.0	0.5	10			10	30	5.0	0.02	50	30	10	5.0	5.0	0.1	1.0	94
NDF9410	20	200	25	25	5.0	950	2000	0.1	100	0.1	4.0	0.5	4.0	0.5	10			10	30	5.0	0.02	50	30	10	10	10	0.1	1.0	94

† V_{DG} = 35V

Table 13. N-Channel Selection Guide: Ultra Low Leakage Dual JFETs

Type No.	OPERATING CONDITIONS FOR THESE CHARACTERISTICS										V _p (V)	I _{DSS} (mA)	G _f (mmho)	G _{oss} (μmho)	I _{GSS} (pA) @ V _{GS} (V)	C _{iss} (pF)	C _{rss} (pF)	BV _{GSS} (V)	I _{G1} -I _{G2} @ 125°C (nA)	Process No.		
	Oper. Cond. V _{DG} (V)	I _D (μA)	V _{GS1-2} V _{OS} (mV) Max	ΔV _{GS} DRIFT (μV/°C) Max	I _G (pA) Max	G _f (mMho) Min	G _{oss} (μMho) Max	V _{GS} (V) Min Max	Min	Max											Min	Max
2N5902	10	30	5	5	3	50μ	1	4	0.6	4.5	30μ	0.5	70μ	0.25	5	5	20	3	1.5	40	2	84
2N5903	10	30	5	10	3	50μ	1	4	0.6	4.5	30μ	0.5	70μ	0.25	5	5	20	3	1.5	40	2	84
2N5904	10	30	10	20	3	50μ	1	4	0.6	4.5	30μ	0.5	70μ	0.25	5	5	20	3	1.5	40	2	84
2N5905	10	30	15	40	3	50μ	1	4	0.6	4.5	30μ	0.5	70μ	0.25	5	5	20	3	1.5	40	2	84
2N5906	10	30	5	5	1	50μ	1	4	0.6	4.5	30μ	0.5	70μ	0.25	5	2	20	3	1.5	40	0.2	84
2N5907	10	30	5	10	1	50μ	1	4	0.6	4.5	30μ	0.5	70μ	0.25	5	2	20	3	1.5	40	0.2	84
2N5908	10	30	10	20	1	50μ	1	4	0.6	4.5	30μ	0.5	70μ	0.25	5	2	20	3	1.5	40	0.2	84
2N5909	10	30	15	40	1	50μ	1	4	0.6	4.5	30μ	0.5	70μ	0.25	5	2	20	3	1.5	40	0.2	84

Table 14. P-Channel Selection Guide: Switches

Transistor Type	BV _{GSS} BV _{GDO}		I _{GSS} I _{DGO}		I _{D(off)}			V _p				I _{DSS}			r _{ds}		C _{iss}		V _{GS}	C _{rss}		V _{GS}	t _{on} (ns) Max	t _{off} (ns) Max	Process No.	
	(V) @ I _G Min	(V) @ I _G Max	(nA) @ V _{DG} Max	(V) @ V _{DG} Max	(nA) @ V _{DS} Max	(V) @ V _{DS} Max	(V) @ V _{DS} Max	(V) @ V _{DS} Min	(V) @ V _{DS} Max	(V) @ V _{DS} Max	(V) @ V _{DS} Max	(V) @ V _{DS} Max	(V) @ V _{DS} Max	(V) @ V _{DS} Max	(V) @ V _{DS} Max	(V) @ V _{DS} Max	(V) @ V _{DS} Max	(V) @ V _{DS} Max		(V) @ V _{DS} Max	(V) @ V _{DS} Max					(V) @ V _{DS} Max
2N3382	30	1	15	30	2	-5	6	1	5	-5	1	3	30	10	300											88
2N3384	30	1	15	30	2	-5	6	4	5	-5	1	15	30	10	180											88
2N3386	30	1	15	30	2.5	-5	10	4	9.5	-5	1	15	50	10	150											88
2N3993	25	1	1.2*	15	1.2	-10	10	4	9.5	-10	1	10	10	150		16	-10	0	4.5	0	10					88
2N3993A	25	1	1.2*	15	1.2	-10	10	4	9.5	-10	1	10	10	150		12	-10	0	3	0	10					88
2N3994	25	1	1.2*	15	1.2	-10	6	1	5.5	-10	1	2	10	300		16	-10	0	4.5	0	10					88
2N3994A	25	1	1.2*	15	1.2	-10	6	1	5.5	-10	1	2	10	300		12	-10	0	3	0	10					88
2N5018	30	1	2	15	10	-15	12	10	-15	1	10	20	75		45	-15	0	10	0	12	35	65			88	
2N5019	30	1	2	15	10	-15	7	5	-15	1	5	20	150		45	-15	0	10	0	7	90	125			88	
•2N5114	30	1	0.5	20	0.5	-15	12	5	10	-15	.001	30	90	18	75	1	25	-15	0	7	0	12	16	21	88	
•2N5115	30	1	0.5	20	0.5	-15	7	3	6	-15	.001	16	60	15	100	1	25	-15	0	7	0	7	30	38	88	
•2N5116	30	1	0.5	20	0.5	-15	5	1	4	-15	.001	5	25	15	150	1	25	-15	0	7	0	5	42	60	88	
J174	30	1	1	20	1	-15	10	5	10	-15	.01	20	100	15	85	1	11	0	10	5.5	0	10	2	5	88	
J175	30	1	1	20	1	-15	10	3	6	-15	.01	7	60	15	125	.5	11	0	10	5.5	0	10	5	10	88	
J176	30	1	1	20	1	-15	10	1	4	-15	.01	2	25	15	250	25	11	0	10	5.5	0	10	15	15	88	
J177	30	1	1	20	1	-15	10	.8	2.25	-15	.01	1.5	20	15	300	.1	11	0	10	5.5	0	10	20	20	88	
P1086E	30	1	2	20	10	-15	10	10	-15	.01	10	15	75	1	45	-15	0	10	15	0	35	50			88	
P1087E	30	1	2	20	10	-15	5	5	-15	.01	5	15	150		45	-15	0	10	15	0	40	75			88	
U304	30	1	0.5	20	0.5	-15	12	5	10	15	1	30	90	15	85		27	-15	0	7	0	12	35	35	88	
U305	30	1	0.5	20			7	3	4	15	1	15	60	15	110		27	-15	0	7	0	7	50	45	88	
U306	30	1	0.5	20			5	1	4	15	1	5	25	15	175		27	-15	0	7	0	5	60	80	88	

• Note. JAN qualified per applicable MIL-S-19500 specification

Table 15. P-Channel Selection Guide: Amplifiers

Transistor Type	BV _{GSS} BV _{GDO}		I _{GSS} I _{DGO}		V _p			I _{DSS}			G _{fs}		G _{oss}		C _{iss}		V _{GS}	C _{rss}		V _{GS}	e _n		Process No.		
	(V) @ I _G Min	(V) @ I _G Max	(nA) @ V _{DG} Max	(V) @ V _{DG} Max	(V) @ V _{DS} Min	(V) @ V _{DS} Max	(V) @ V _{DS} Max	(V) @ V _{DS} Min	(V) @ V _{DS} Max	(V) @ V _{DS} Max	(mmho) @ V _{DS} Min	(mmho) @ V _{DS} Max	(μmho) @ V _{DS} Max	(μmho) @ V _{DS} Max	(pF) @ V _{DS} Max	(V) @ V _{DS} Max		(pF) @ V _{DS} Max	(V) @ V _{DS} Max		(V) @ V _{DS} Max	(V) @ V _{DS} Max		(V) @ V _{DS} Max	(V) @ V _{DS} Max
•2N2608	30	1	10	30	1	4	-5	1	0.9	4.5	5	1	5		17	-5	1					125	1000	89	
2N2609	30	1	30	30	1	4	-5	1	2	10	5	2.5	5		30	-5	1					125	1000	88	
2N3329	20	10	10	10	5	-15	10	1	3	10	1	2	10/1mA	20	10	20	-10	1				125	1000	89	
2N3330	20	10	10	10	6	-15	10	2	6	10	1.5	3	10/2mA	40	10	20	-10	1				125	1000	89	
2N3331	20	10	10	10	8	-15	10	5	15	10	2	4	10/5mA	100	10	20	-10	1				155	1000	89	
2N3332	20	10	10	10	6	-15	10	1	6	10	1	2.2	10/1mA	20	10	20	-10	1				65	1000	89	
2N4381	25	1	1	15	1	5	-15	1	3	12	15	2	6	15	75	15	20	-15	0	5	-15	0	20	1000	89
2N4382	25	1	1	15	2.5	9	-15	1	10	30	15	4	8	15	100	15	20	-15	0	5	-15	0	20	1000	88

• Note. JAN qualified per applicable MIL-S-19500 specification

Transistor Type	BV _{GSS} BV _{GDO}		I _{GSS} I _{DGO}		V _p			I _{DSS}			G _{fs}		G _{oss}		C _{iss}		V _{GS}	C _{rss}		V _{GS}	e _n		Process No.		
	(V) @ I _G Min	(V) @ I _G Max	(nA) @ V _{DG} Max	(V) @ V _{DG} Max	(V) @ V _{DS} Min	(V) @ V _{DS} Max	(V) @ V _{DS} Max	(V) @ V _{DS} Min	(V) @ V _{DS} Max	(V) @ V _{DS} Max	(mmho) @ V _{DS} Min	(mmho) @ V _{DS} Max	(μmho) @ V _{DS} Max	(μmho) @ V _{DS} Max	(pF) @ V _{DS} Max	(V) @ V _{DS} Max		(pF) @ V _{DS} Max	(V) @ V _{DS} Max		(V) @ V _{DS} Max	(V) @ V _{DS} Max		(V) @ V _{DS} Max	(V) @ V _{DS} Max
2N5020	25	1	1	15	0.3	1.5	-15	1	0.3	1.2	15	1	3.5	15	20	15	25	-15	0	7	-15	0	30	1000	89
2N5021	25	1	1	15	0.5	2.5	-15	1	1	3.5	15	1.5	6	15	20	15	25	-15	0	7	-15	0	30	1000	89
2N5460	40	10	5	20	0.75	6	-15	1	1	5	15	1	4	15	50	15	7	-15	0	2	-15	0	115	100	89
2N5461	40	10	5	20	1	7.5	-15	1	2	9	15	1.5	5	15	50	15	7	-15	0	2	-15	0	115	100	89
2N5462	40	10	5	20	1.8	9	-15	1	4	16	15	2	6	15	50	15	7	-15	0	2	-15	0	115	100	89
J270	30	1	0.2	20	0.5	2.0	15	.001	2	15	15	6.0	15.0	15	200	15	120	15	0	15	15	0	110	1k	88
J271	30	1	0.2	20	1.5	4.5	15	.001	6	50	15	8.0	18.0	15	500	15	120	15	0	15	15	0	110	1k	88
PN4342	25	10	10	15		5.5	-10	1	4	12	10	2	6	10	75	10	20	-10	0	5	-10	0	80	100	89
PN4343	25	10	10	15		10	-10	1	10	30	10	4	8	10	100	10	20	-10	0	5	-10	0	80	100	88
PN4360	20	10	10	15	0.7	10	-10	1	3	30	10	2	8	10	100	10	20	-10	0	5	-10	0	190	100	89
PN5033	20	10	10	15	0.3	2.5	-10	1	0.3	3.5	10	1	5	10	20	10	25	-10	0	7	-10	0	100	1000	89
U300	40	1	0.1	20	5	10	-15	.001	30	90		8	12	15		20	-15	15 mA	5.5	-15	15 mA	40	1000	88	
U301	40	1	0.1	20	2.5	60	-15	.001	15	60		7	11	15		20	-15	7 mA	5.5	-15	5.5 mA	40	1000	88	

Table 16. Pro-Electron JFETs: Amplifiers

Type No.	BV _{GSS} BV _{GDO} (V) @ I _G		I _{GSS} I _{DGD} (nA) @ V _{GD}		V _p (V) @ V _{DS}			I _D (nA)	V _{GS} (V) @ V _{DS}				I _{DSS} (mA) @ V _{DS}		R _e (Y _{FS}) (mmho) @ f		C _{iss} (pF) @ V _{DS}		V _{GS} (V)	C _{rss} (pF) @ V _{DS}		V _{GS} (V)	NF (dB) @ R _G = 1k e _n * f		Process No.		
	Min	Max	Min	Max	Min	Max	Max		Min	Max	Max	Min	Max	Min	Max	Typ	Typ	Typ		Typ	Max		Typ	Max		Typ	(Hz)*
BF244A	30	1	5	20	.5	8	15	10	.4	2.2	15	200	2	6.5	15	3	6.5	.001	4	20	-1	1.1	20	-1	1.5	100	50
BF244B	30	1	5	20	.5	8	15	10	1.6	3.8	15	200	6	15	15	3	6.5	.001	4	20	-1	1.1	20	-1	1.5	100	50
BF244C	30	1	5	20	.5	8	15	10	3.2	7.5	15	200	12	25	15	3	6.5	.001	4	20	-1	1.1	20	-1	1.5	100	50
BF245A	30	1	5	20	.5	8	15	10	.4	2.2	15	200	2	6.5	15	3	6.5	.001	4	20	-1	1.1	20	-1			50
BF245B	30	1	5	20	.5	8	15	10	1.6	3.8	15	200	6	15	15	3	6.5	.001	4	20	-1	1.1	20	-1			50
BF245C	30	1	5	20	.5	8	15	10	3.2	7.5	15	200	12	25	15	3	6.5	.001	4	20	-1	1.1	20	-1			50
BF246A	25	1	5	15	.6	14.5	15	10	1.5	4.0	15	200	30	80	15	8		.001	11	15	0	3.5	15	0			51
BF246B	25	1	5	15	.6	14.5	15	10	3.0	7.0	15	200	60	140	15	8		.001	11	15	0	3.5	15	0			51
BF246C	25	1	5	15	.6	14.5	15	10	5.5	12	15	200	110	250	15	8		.001	11	15	0	3.5	15	0			51
BF247A	25	1	5	15	.6	14.5	15	10	1.5	4.0	15	200	30	80	15	8		.001	11	15	0	3.5	15	0			51
BF247B	25	1	5	15	.6	14.5	15	10	3.0	7.0	15	200	60	140	15	8		.001	11	15	0	3.5	15	0			51
BF247C	25	1	5	15	.6	14.5	15	10	5.5	12	15	200	110	250	15	8		.001	11	15	0	3.5	15	0			51
BF256A	30	1	5	20					.5	7.5	15	200	3	7	15	4.5		.001				.7	20	-1	7.5	800	50
BF256B	30	1	5	20					.5	7.5	15	200	6	13	15	4.5		.001				.7	20	-1	7.5	800	50
BF256C	30	1	5	20					.5	7.5	15	200	11	18	15	4.5		.001				.7	20	-1	7.5	800	50
BC264A	30	1	10	20	.5		15	10	.2	1.2	15	1000	2	4.5	15	2.5		.001	4.0	15	-1	1.2	15	-1	40*	10*	50
BC264B	30	1	10	20	.5		15	10	.4	1.4	15	1500	3.5	6.5	15	3.0		.001	4.0	15	-1	1.2	15	-1	40*	10*	50
BC264C	30	1	10	20	.5		15	10	.5	1.5	15	2500	5.0	8.0	15	3.5		.001	4.0	15	-1	1.2	15	-1	40*	10*	50
BC264D	30	1	10	20	.5		15	10	.6	1.6	15	3500	7.0	12.0	15	4.0		.001	4.0	15	-1	1.2	15	-1	40*	10*	50

JFET Process Characteristics

This section contains complete design curves for all of Fairchild Semiconductor's discrete JFET processes. Temperature and $V_{GS(off)}$ distribution data is provided to facilitate worst-case design. In addition a complete list of all device types supplied from this process is included to aid in cross reference searches and the selection of preferred

device types. The curves in this section should be considered typical of the process supplied by Fairchild Semi-conductor. Every effort is made to keep the process in tolerance with the published graphs, but the exact distribution of any specific lot of material is not guaranteed.



Process 50 N-Channel JFET

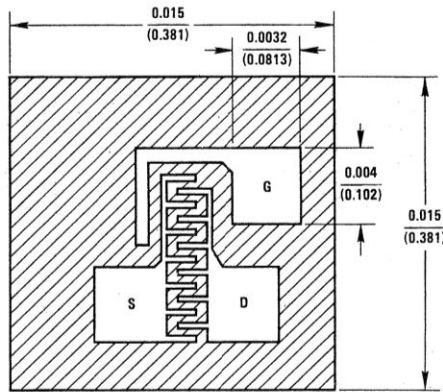

GATE IS ALSO BACKSIDE CONTACT

DESCRIPTION

Process 50 is designed primarily for RF amplifier and mixer applications. It will operate up to 450 MHz with low noise figure and good power gain. These devices offer outstanding performance at VHF aircraft and communications frequencies. Their major advantage is low crossmodulation and intermodulation, low noise figure and good power gain. The device is also a good choice for analog switching where low capacitance is very important.

CHARACTERISTIC	PARAMETER	TEST CONDITIONS	MIN	TYP	MAX	UNITS
Gate-Source Breakdown Voltage	BV_{GSS}	$V_{DS} = 0V, I_G = -1 \mu A$	-25	-40		V
Zero Gate Voltage Drain Current	I_{DSS}	$V_{DS} = 15V, V_{GS} = 0V$	1.0	10	20	mA
Forward Transconductance	g_{fs}	$V_{DS} = 15V, V_{GS} = 0$	3.0	5.5	7.0	mmhos
Forward Transconductance	g_{fs}	$V_{DG} = 15V, I_D = 200 \mu A$		1.1		mmhos
Reverse Gate Leakage	I_{GSS}	$V_{GS} = -20V, V_{DS} = 0$		-5.0	-100	pA
"ON" Resistance	r_{DS}	$V_{DS} = 100 mV, V_{GS} = 0$	100	175	500	Ω
Pinch Off Voltage	$V_{GS(OFF)}$	$V_{DS} = 15V, I_D = 1 nA$	-0.7	-3.5	-6.0	V
Output Conductance	g_{os}	$V_{DG} = 15V, I_D = 1 mA, f = 1 kHz$		10		$\mu mhos$
Feedback Capacitance	C_{rss}	$V_{DG} = 15V, V_{GS} = 0$		0.7	0.9	pF
Input Capacitance	C_{iss}	$V_{DS} = 15V, V_{GS} = 0$		3.5	4.0	pF
Noise Voltage	e_n	$V_{DG} = 15V, I_D = 1 mA, f = 100 Hz$		8.0		nV/\sqrt{Hz}
Noise Figure	NF	$V_{DG} = 15V, I_D = 5 mA, R_G = 1 k\Omega, f = 400 MHz$		2.2	4.0	dB
Power Gain	G_{PS}	$V_{DG} = 15V, I_D = 5 mA, f = 400 MHz$		12		dB

Examples of process 50 part numbers are as follows. * Denotes preferred parts.

2N3823	*2N5484	PN5163	2N5949	BC264C
2N3966	*2N5485	MPF102	2N5950	BC264D
2N4223	*2N5486	MPF106	2N5951	BF245A
2N4224	2N5555	MPF107	2N5952	BF245B
2N4416	2N5668	MPF110	2N5953	BF245C
*2N4416A	2N5669	MPF111	BC264A	BF256A
2N5078	2N5670		BC264B	BF256B
2N5103	*J304	2N3819		BF256C
2N5104	*J305	2N5248		
2N5105	PN4223	BF244A		
2N5556	PN4224	BF244B		
2N5557	*PN4416	BF244C		
2N5558		TIS58		
		TIS59		

QUALIFIED PER MIL-S-19500
 2N3823JAN, JANTX, JANTXV
 2N4416AJAN, JANTX, JANTXV

Process 50

Transfer Characteristics

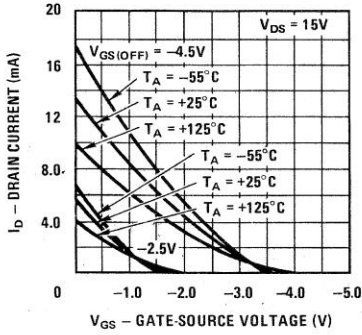

Channel Resistance vs Temperature

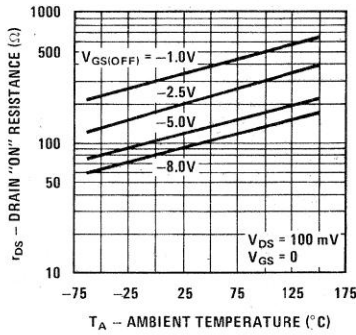

Leakage Current vs Voltage

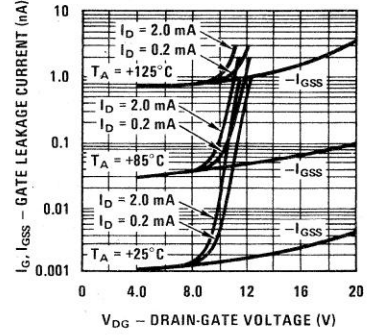

Transconductance Characteristics

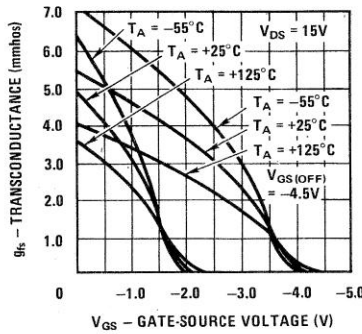

Common Drain-Source Characteristics

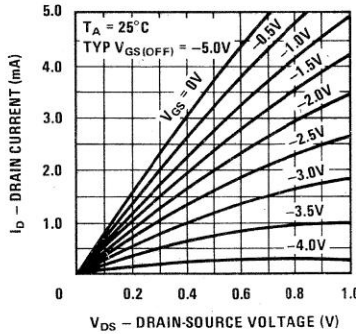

Output Conductance vs Drain Current

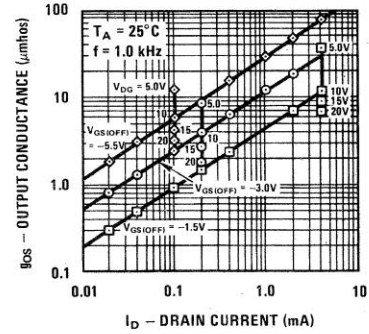

Parameter Interactions

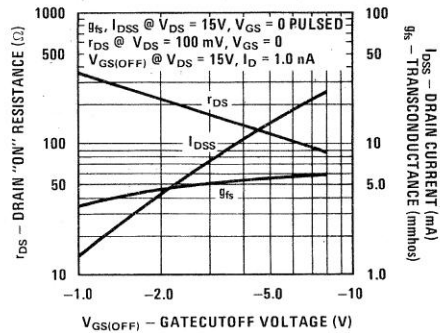

Transconductance vs Drain Current

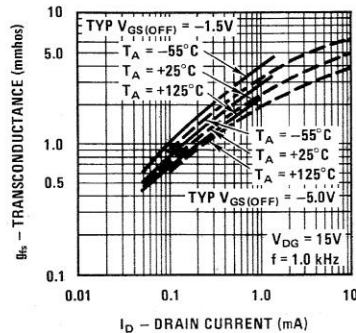

Noise Voltage vs Frequency

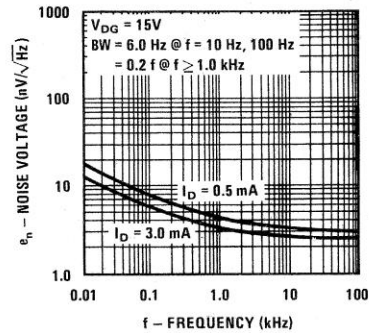

Capacitance vs Voltage

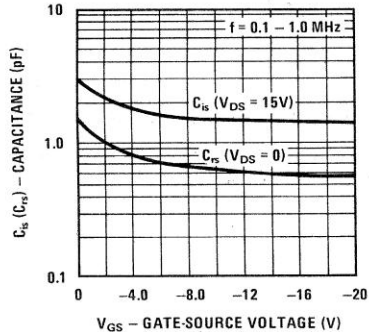

Noise Figure Frequency

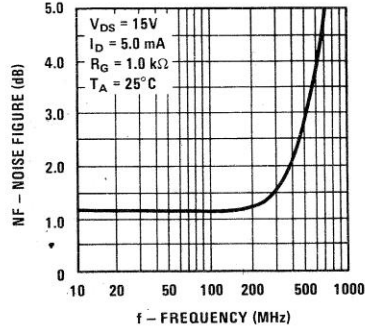

Process 50

COMMON SOURCE

Input Admittance

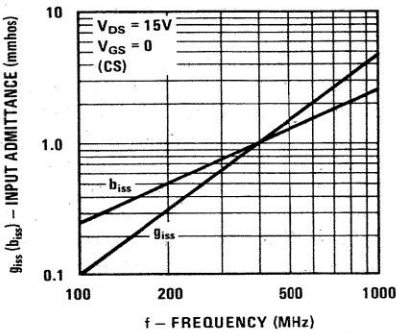

Forward Transadmittance

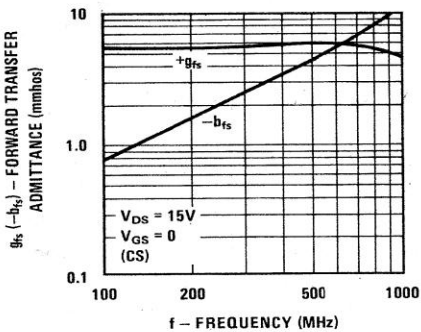

Output Admittance

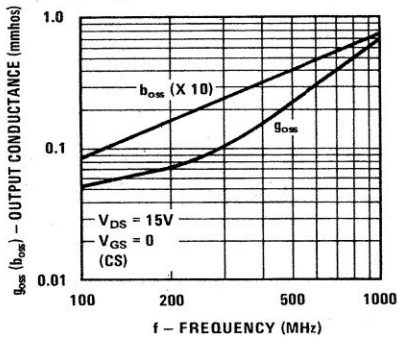

Reverse Transadmittance

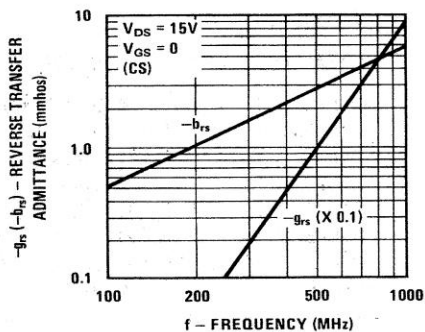

COMMON GATE

Input Admittance

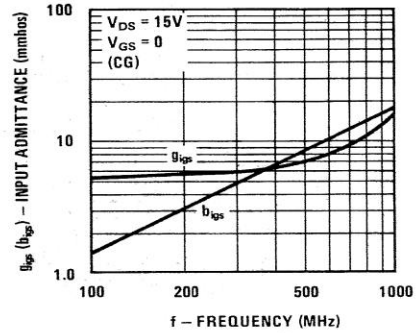

Forward Transadmittance

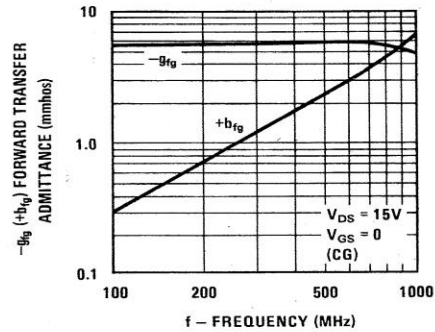

Output Admittance

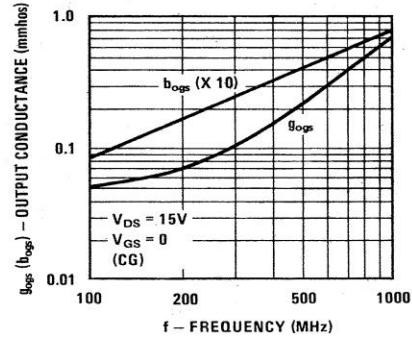

Reverse Transadmittance

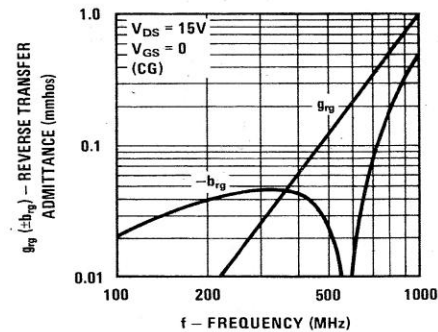

Process 51 N-Channel JFET

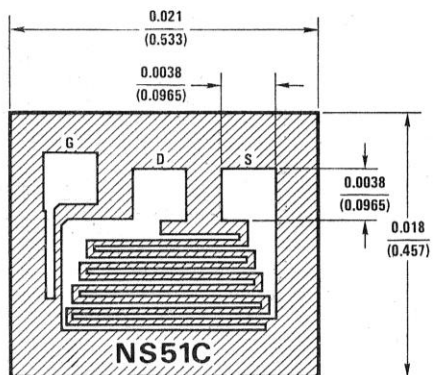

GATE IS ALSO BACKSIDE CONTACT

DESCRIPTION

Process 51 is designed primarily for electronic switching applications such as low ON resistance analog switching. It features excellent C_{iss} , $R_{DS(ON)}$ time constant. The inherent zero offset voltage and low leakage current make these devices excellent for chopper stabilized amplifiers, sample and hold circuits, and reset switches. Low feed-through capacitance also allows them to handle video signals to 100 MHz.

CHARACTERISTIC	PARAMETER	TEST CONDITIONS	MIN	TYP	MAX	UNITS
Gate-Source Breakdown Voltage	BV_{GSS}	$V_{DS} = 0V, I_G = -1 \mu A$	-30	-50		V
Zero Gate Voltage Drain Current	I_{DSS}	$V_{DS} = 20V, V_{GS} = 0$ Pulse Test	5.0	65	170	mA
Reverse Gate Leakage	I_{GSS}	$V_{GS} = -20V, V_{DS} = 0$		-15	-200	pA
"ON" Resistance	r_{DS}	$V_{DS} = 100 mV, V_{GS} = 0$	20	35	100	Ω
Forward Trans-conductance	g_{fs}	$V_{DG} = 15V, I_D = 2 mA$		8.5		mmhos
Pinch Off Voltage	$V_{GS(OFF)}$	$V_{DS} = 20V, I_D = 1 nA$	-0.5	-4.5	-9.0	V
Drain "OFF" Current	$I_{D(OFF)}$	$V_{DS} = 20V, V_{GS} = -10V$		15	200	pA
Feedback Capacitance	C_{rss}	$V_{DG} = 15V, I_D = 5 mA, f = 1 MHz$		3.5	4.0	pF
Input Capacitance	C_{iss}	$V_{DS} = 15V, I_D = 5 mA, f = 1 MHz$		12	16	pF
Noise Voltage	e_n	$V_{DG} = 15V, I_D = 1 mA, f = 100 Hz$		6.0		nV/\sqrt{Hz}
Turn-On Time	t_{on}	$V_{DD} = 10V, I_D = 6.6 mA$		12	20	ns
Turn-Off Time	t_{off}	$V_{DD} = 10V, I_D = 6.6 mA$		40	80	ns

Examples of process 51 part numbers are as follows. *Denotes preferred parts.

2N3970	2N4861	*PN4092	BF247A
2N3971	2N4861A	*PN4093	BF247B
2N3972		*PN4391	BF247C
*2N4091	*NF5101	*PN4392	TIS73
*2N4092	*NF5102	*PN4393	TIS74
*2N4093	*NF5103	*PN4856	TIS75
*2N4391		*PN4857	
*2N4392	*2N5638	*PN4858	
*2N4393	*2N5639	*PN4859	
*2N4856	*2N5640	*PN4860	
2N4856A	2N5653	*PN4861	
*2N4857	2N5654	U1897E	
2N4857A	*J111	U1898E	
*2N4858	*J112	U1899E	
2N4858A	*J113		
2N4859	*PF5101	BF246A	
2N4859A	*PF5102	BF246B	
2N4860	*PF5103	BF246C	
2N4860A	*PN4091		

QUALIFIED PER MIL-S-19500

2N4091 JAN, JANTX, JANTXV
 2N4092 JAN, JANTX, JANTXV
 2N4093 JAN, JANTX, JANTXV
 2N4856 JAN, JANTX, JANTXV
 2N4857 JAN, JANTX, JANTXV
 2N4858 JAN, JANTX, JANTXV
 2N4859 JAN, JANTX, JANTXV
 2N4860 JAN, JANTX, JANTXV
 2N4861 JAN, JANTX, JANTXV

Process 51

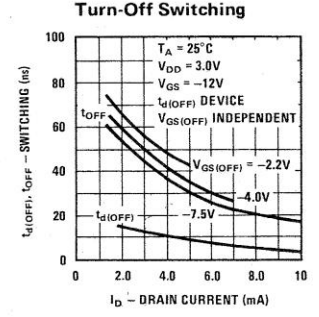
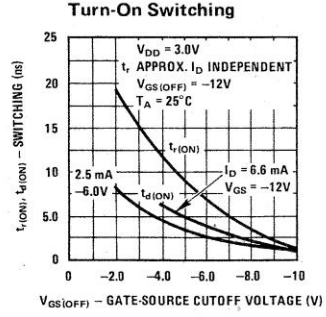
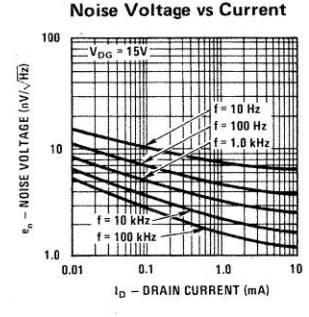
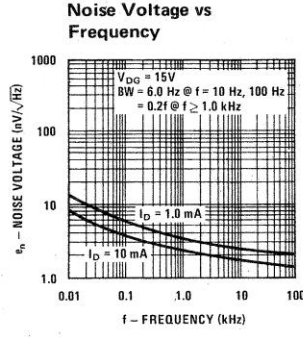
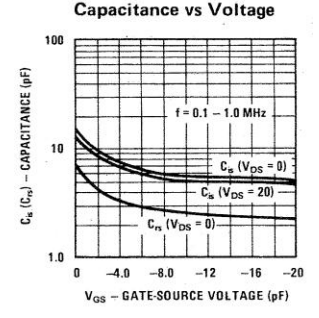
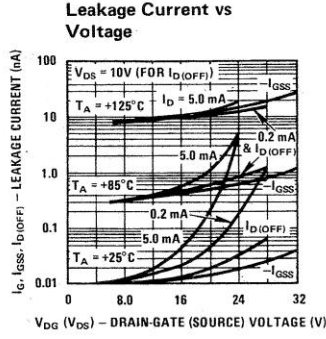
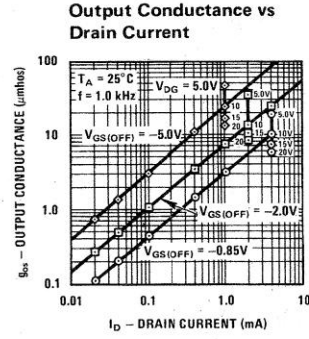
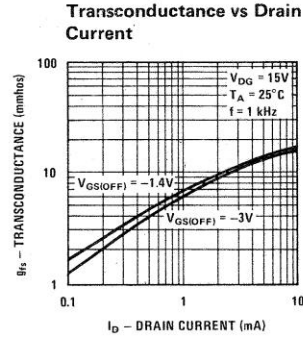
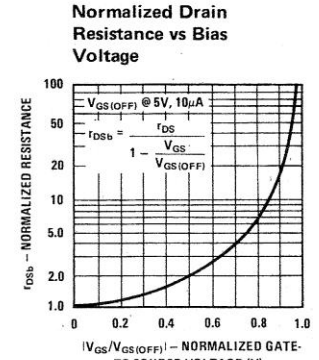
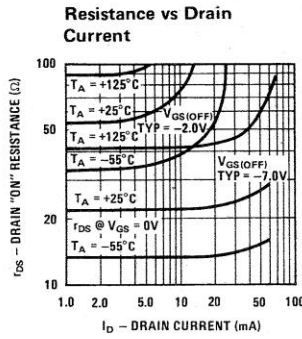
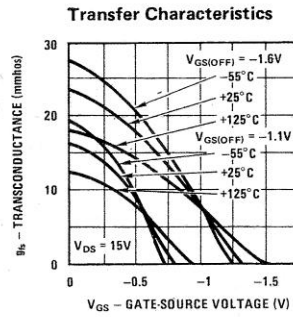
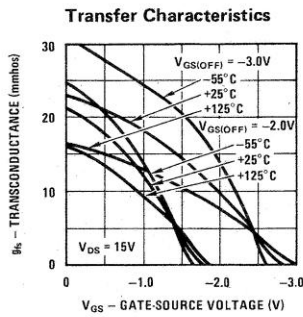
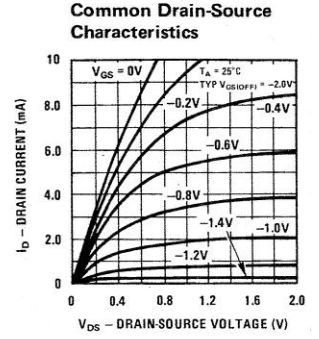
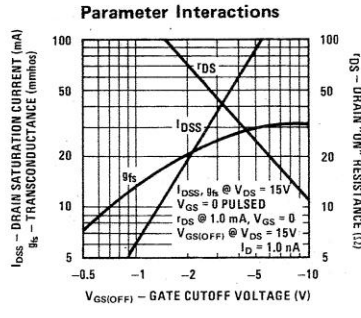
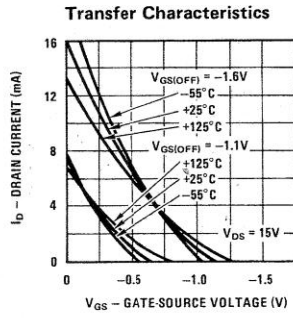
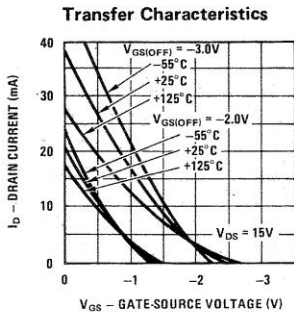

Process 52 N-Channel JFET

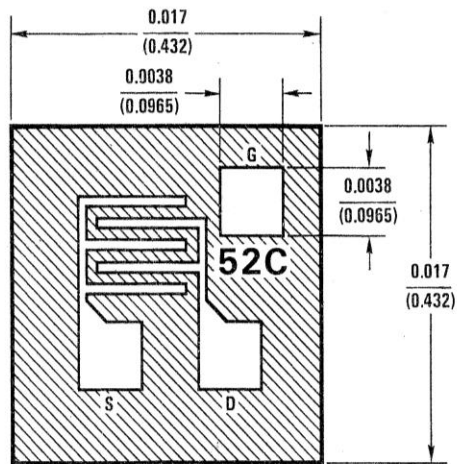

GATE IS ALSO BACKSIDE CONTACT

DESCRIPTION

Process 52 is designed primarily for low level audio and general purpose applications. These devices provide excellent performance as input stages for piezo electric transducers or other high impedance signal sources. Their high output impedance and high voltage breakdown lend them to high gain audio and video amplifier applications. Source and drain are interchangeable.

CHARACTERISTIC	PARAMETER	CONDITIONS	MIN	TYP	MAX	UNITS
Gate-Source Breakdown Voltage	BV_{GS}	$V_{DS} = 0V, I_G = -1 \mu A$	-40	-70		V
Drain Saturation Current	I_{DSS}	$V_{DS} = 20V, V_{GS} = 0V$	0.2	1.5	12	mA
Forward Transconductance	g_{fs}	$V_{DS} = 20V, V_{GS} = 0V$	1.0	2.5	5.0	mmho
Forward Transconductance	g_{fs}	$V_{DS} = 20V, I_D = 200 \mu A$		700		μmho
Reverse Gate Leakage Current	I_{GSS}	$V_{GS} = -30V, V_{DS} = 0V$		-10		pA
Drain ON Resistance	r_{DS}	$V_{DS} = 100 mV, V_{GS} = 0V$	250	400	2000	Ω
Gate Cutoff Voltage	$V_{GS(OFF)}, V_P$	$V_{DS} = 15V, I_D = 1 nA$	-0.3	1.0	-8.0	V
Output Conductance	g_{os}	$V_{DG} = 15V, I_D = 200 \mu A$		2.0		μmho
Feedback Capacitance	C_{rss}	$V_{DG} = 15V, V_{GS} = 0V, f = 1 MHz$		1.3	1.8	pF
Input Capacitance	C_{iss}	$V_{DG} = 15V, V_{GS} = 0V, f = 1 MHz$		5	6	pF
Noise Voltage	e_n	$V_{DG} = 15V, I_D = 200 \mu A, f = 100 Hz$		10		nV/\sqrt{Hz}

Examples of process 52 part numbers are as follows.

*Denotes preferred parts.

2N3069	*2N3684	*J201
2N3070	*2N3685	*J202
2N3071	*2N3686	*J203
2N3368	*2N3687	*PN3684
2N3369	2N3967	*PN3685
2N3370	2N3967A	*PN3686
2N3458	2N3968	*PN3687
2N3459	2N3968A	*PN4302
2N3460	2N3969	*PN4303
*2N4338	2N3969A	*PN4304
*2N4339		
*2N4340		
*2N4341		

Process 52

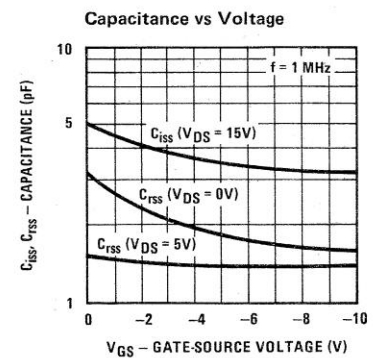
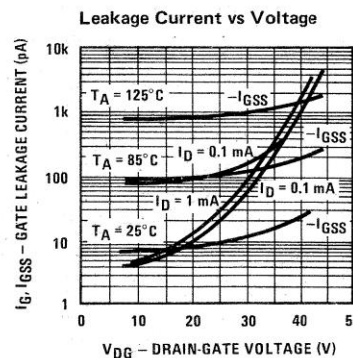
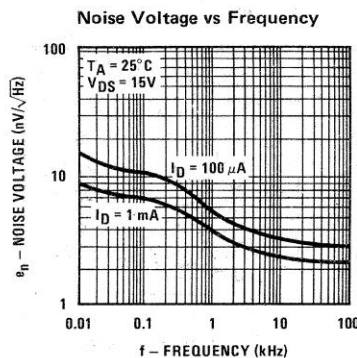
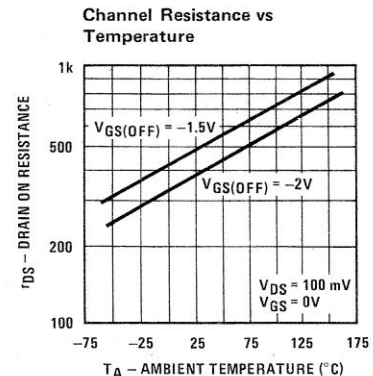
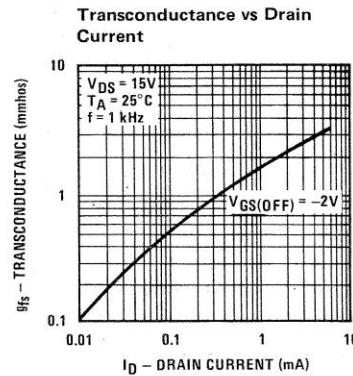
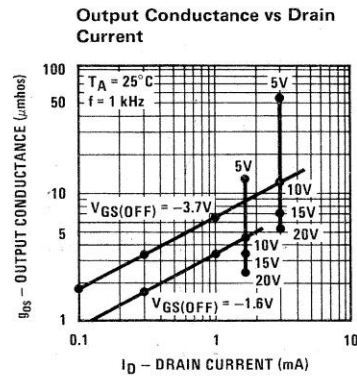
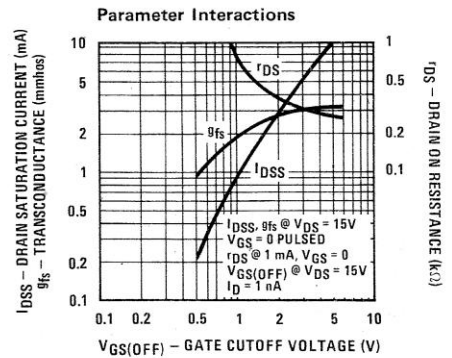
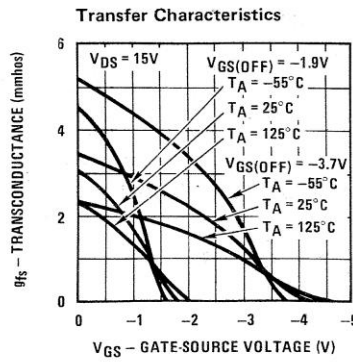
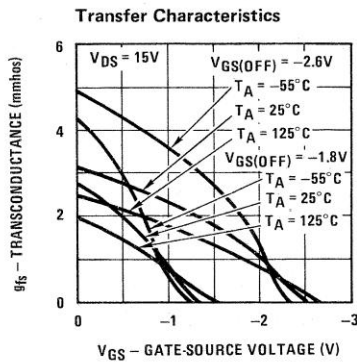
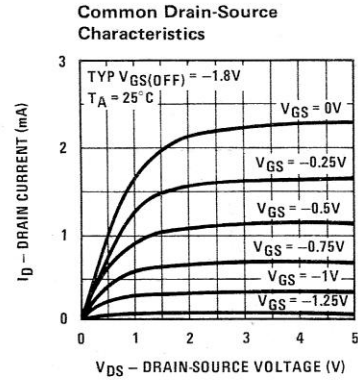
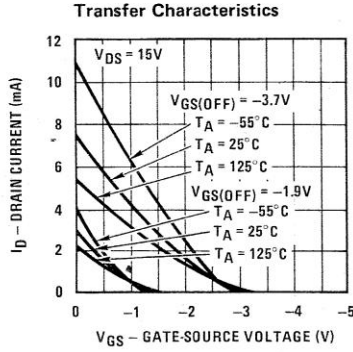
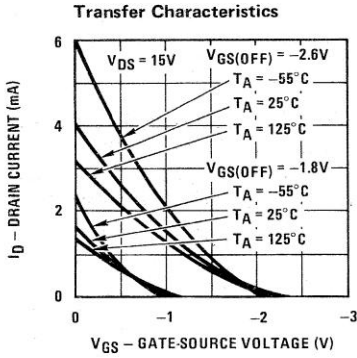

Process 53 N-Channel JFET

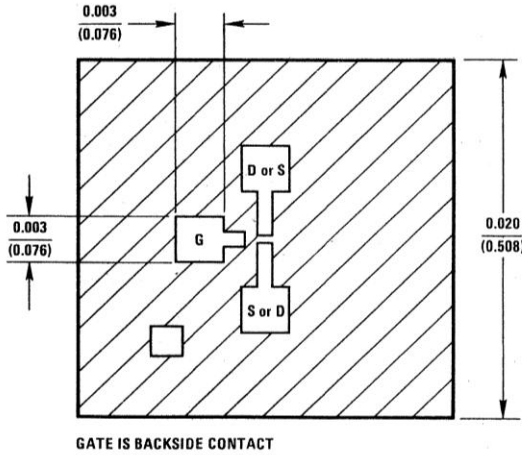

DESCRIPTION

Process 53 is designed primarily for low current DC and audio applications. These devices provide excellent performance as input stages for sub pico-amp instrumentation or any high impedance signal sources.

CHARACTERISTIC	PARAMETER	TEST CONDITIONS	MIN	TYP	MAX	UNITS
Gate-Source Breakdown Voltage	BV_{GSS}	$V_{DS} = 0V, I_G = -1 \mu A$	-40	-60		V
Zero Gate Voltage Drain Current	I_{DSS}	$V_{DS} = 10V, V_{GS} = 0$	0.02	0.25	1.0	mA
Forward Transconductance	g_{fs}	$V_{DS} = 10V, V_{GS} = 0$	80	250	350	μmho
Forward Transconductance	g_{fs}	$V_{DG} = 15V, I_D = 50 \mu A$		120		μmho
Reverse Gate Leakage	I_{GSS}	$V_{GS} = -20V, V_{DS} = 0$		-0.3	-10	pA
Pinch Off Voltage	$V_{GS(OFF)}$	$V_{DS} = 10V, I_D = 1 nA$	-0.5	-2.2	-6.0	V
Feedback Capacitance	C_{rss}	$V_{DG} = 15V, V_{GS} = 0, f = 1 MHz$		0.85	1.0	pF
Input Capacitance	C_{iss}	$V_{DS} = 15V, V_{GS} = 0, f = 1 MHz$		2.0	2.5	pF
Output Conductance	g_{os}	$V_{DG} = 10V, I_D = 50 \mu A$		0.9	5.0	$\mu mhos$
Noise Voltage	e_n	$V_{DG} = 10V, I_D = 50 \mu A, f = 100 Hz$		45	150	nV/\sqrt{Hz}

Examples of process 53 part numbers are as follows.

* Denotes preferred parts.

- 2N4117
- * 2N4117A
- 2N4118
- * 2N4118A
- 2N4119
- * 2N4119A

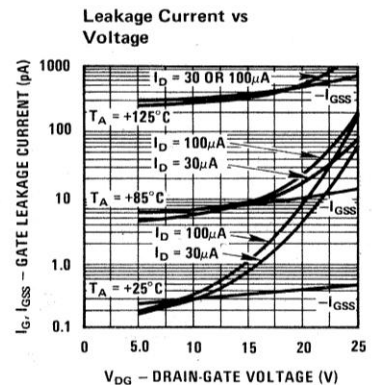
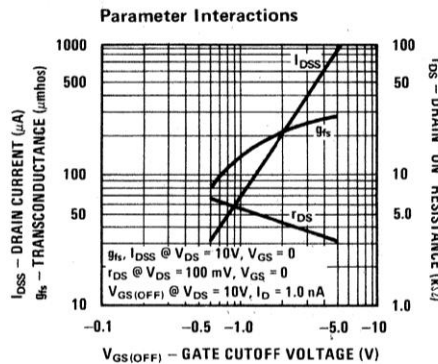

Process 53

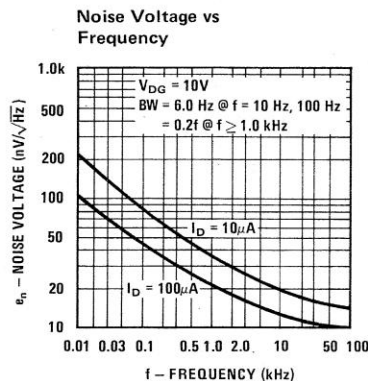
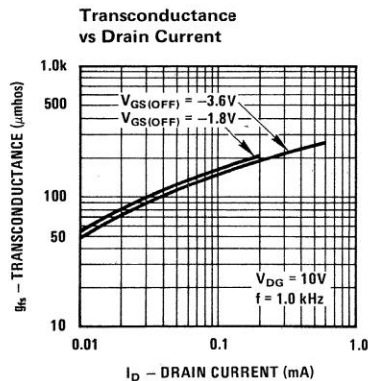
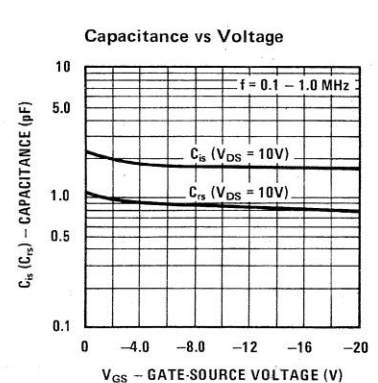
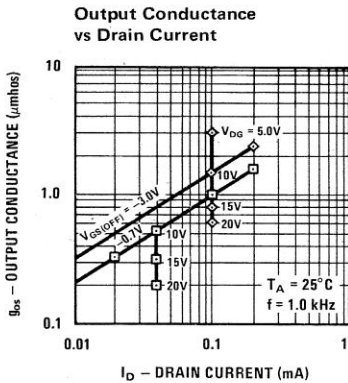
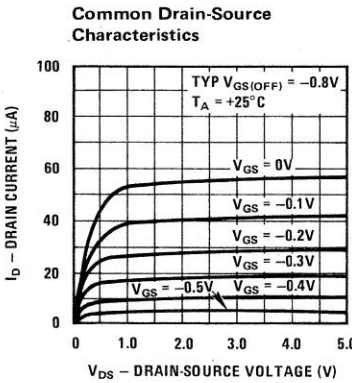
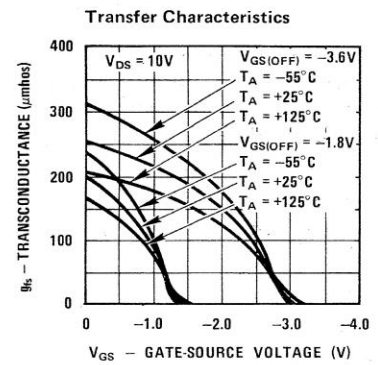
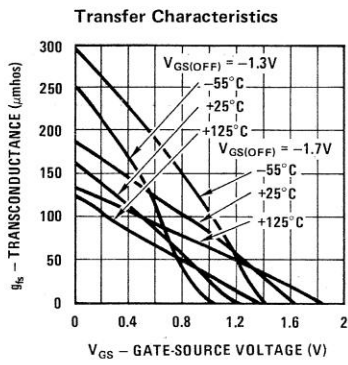
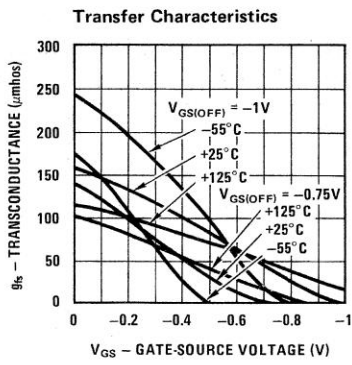
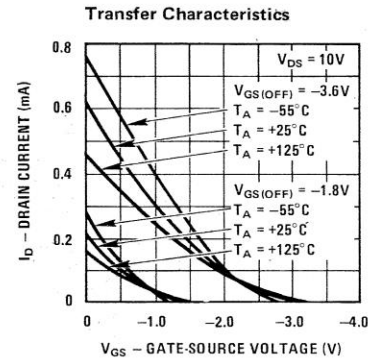
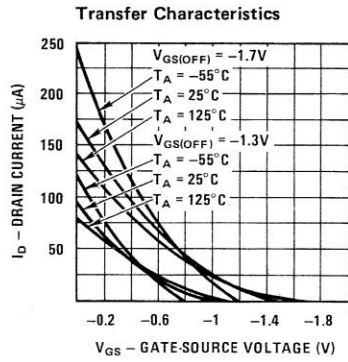
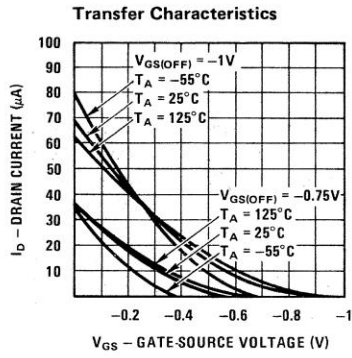

Process 55 N-Channel JFET

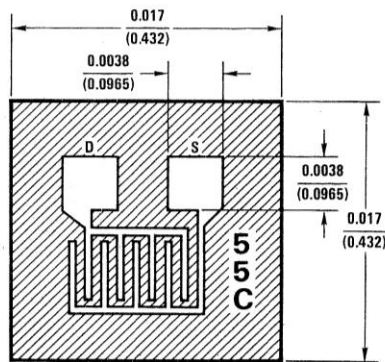

GATE IS BACKSIDE CONTACT

DESCRIPTION

Process 55 is a general purpose low level audio amplifier and switching transistor. Wafer processing is similar to process 52 but process 55 uses a larger geometry. This results in higher Y_{fs} , I_{DSS} , and capacitance and lower $R_{DS(ON)}$. It is useful for audio and video frequency amplifiers and RF amplifiers under 50 MHz. It may also be used for analog switching applications.

CHARACTERISTIC	PARAMETER	TEST CONDITIONS	MIN	TYP	MAX	UNITS
Gate-Source Breakdown Voltage	BV_{GSS}	$V_{DS} = 0V, I_G = -1 \mu A$	-40	-70		V
Zero Gate Voltage Drain Current	I_{DSS}	$V_{DS} = 20V, V_{GS} = 0$	0.5	5.0	20	mA
Forward Transconductance	g_{fs}	$V_{DS} = 20V, V_{GS} = 0$	2.0	4.5	7.0	mmho
Forward Transconductance	g_{fs}	$V_{DG} = 15V, I_D = 200 \mu A$		1200		$\mu mhos$
Reverse Gate Leakage	I_{GSS}	$V_{GS} = -30V, V_{DS} = 0$		-10	-100	μA
"ON" Resistance	r_{DS}	$V_{DS} = 100 mV, V_{GS} = 0$	140	250	600	Ω
Pinch Off Voltage	$V_{GS(OFF)}$	$V_{DS} = 20V, I_D = 1 nA$	-0.5	-2.0	-8.0	V
Feedback Capacitance	C_{rss}	$V_{DG} = 15V, V_{GS} = 0, f = 1 MHz$		1.5	2.0	pF
Input Capacitance	C_{iss}	$V_{DS} = 15V, V_{GS} = 0, f = 1 MHz$		6.0	7.0	pF
Output Conductance	g_{os}	$V_{DG} = 15V, I_D = 200 \mu A$		2		$\mu mhos$
Noise Voltage	e_n	$V_{DG} = 15V, I_D = 200 \mu A, f = 100 Hz$		10		nV/\sqrt{Hz}

Examples of process 55 part numbers are as follows. *Denotes preferred parts.

2N3436	*2N5361
2N3437	*2N5362
2N3438	*2N5363
	*2N5364
2N3821	
2N3822	*2N5457
2N3824	*2N5458
2N4220	*2N5459
2N4220A	MPF103
2N4221	MPF104
2N4221A	MPF105
2N4222	MPF108
2N4222A	MPF109
*2N5358	MPF112
*2N5359	PN4220
*2N5360	PN4221
	PN4222

Process 55

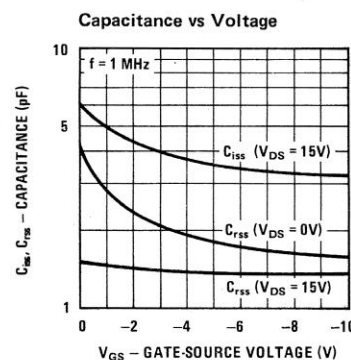
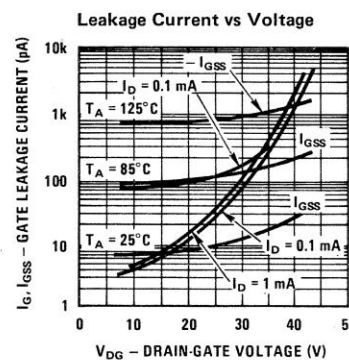
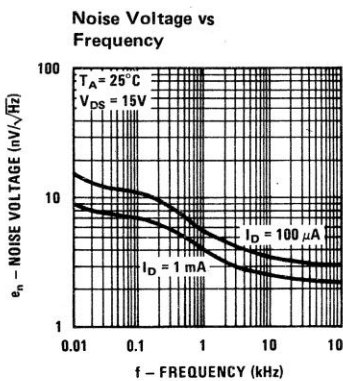
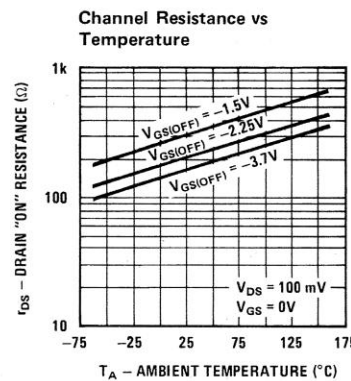
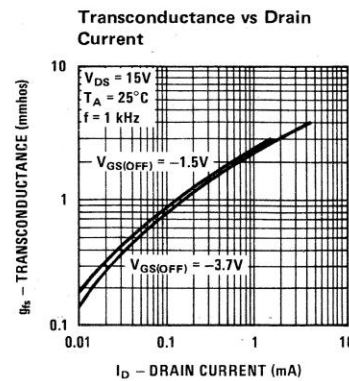
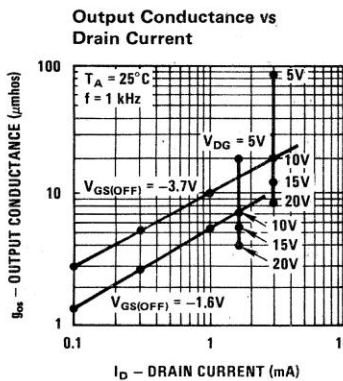
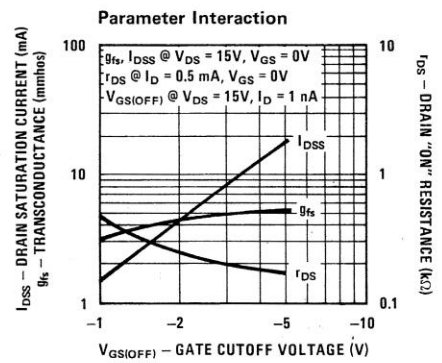
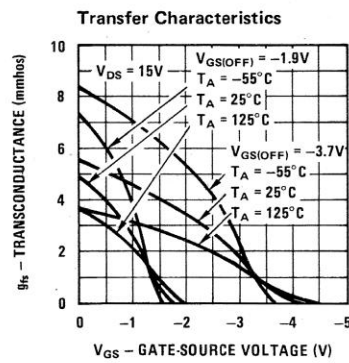
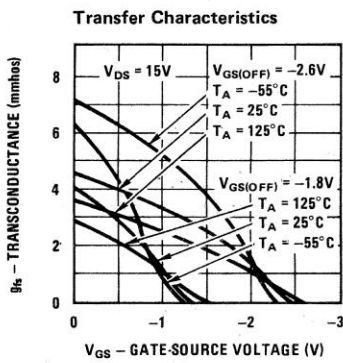
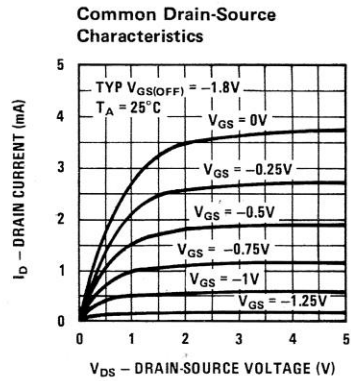
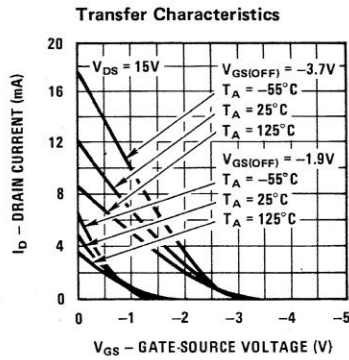
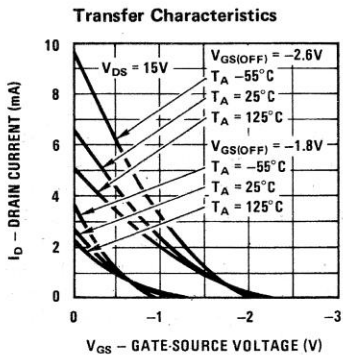

Process 58 N-Channel JFET

DESCRIPTION

Process 58 was developed for analog or digital switching applications where very low $r_{DS(ON)}$ is mandatory. Switching times are very fast and $R_{DS(ON)} C_{iss}$ time constant is low. The 6Ω typical on resistance is very useful in precision multiplex systems where switch resistance must be held to an absolute minimum. With r_{DS} increasing only $0.7\%/^{\circ}\text{C}$, accuracy is retained over a wide temperature excursion.

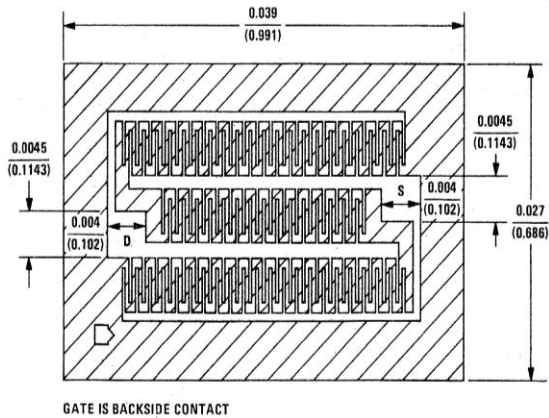

CHARACTERISTIC	PARAMETER	TEST CONDITIONS	MIN	TYP	MAX	UNITS
Gate-Source Breakdown Voltage	BV_{GSS}	$V_{DS} = 0V, I_G = -1\mu A$	-25	-30		V
Zero Gate Voltage Drain Current	I_{DSS}	$V_{DS} = 5V, V_{GS} = 0$ Pulse Test	100	400	1000	mA
Reverse Gate Leakage	I_{GSS}	$V_{GS} = -15V, V_{DS} = 0$		-50	-500	pA
"ON" Resistance	r_{DS}	$V_{DS} = 100\text{ mV}, V_{GS} = 0$	3.0	6.0	20	Ω
Pinch Off Voltage	$V_{GS(OFF)}$	$V_{DS} = 5V, I_D = 3\text{ nA}$	-0.5	-5.0	-12	V
Drain "OFF" Current	$I_{D(OFF)}$	$V_{DS} = 5V, V_{GS} = -10V$		0.05	20	nA
Feedback Capacitance	C_{rss}	$V_{DG} = 15V, I_D = 2\text{ mA}, f = 1\text{ MHz}$		12	25	pF
Input Capacitance	C_{iss}	$V_{DG} = 15V, I_D = 2\text{ mA}, f = 1\text{ MHz}$		25	50	pF
Forward Transconductance	g_{fs}	$V_{DG} = 10V, I_D = 2\text{ mA}$		10		mmhos
Output Conductance	g_{os}	$V_{DG} = 10V, I_D = 2\text{ mA}$		100		μmhos
Noise Voltage	e_n	$V_{DG} = 15V, I_D = 2\text{ mA}, f = 100\text{ Hz}$		6.0		$\text{nV}/\sqrt{\text{Hz}}$

Examples of process 58 part numbers are as follows. *Denotes preferred parts.

U320	*J108	*2N5432
U321	*J109	*2N5433
U322	*J110	*2N5434

Process 58

Common Drain-Source Characteristics

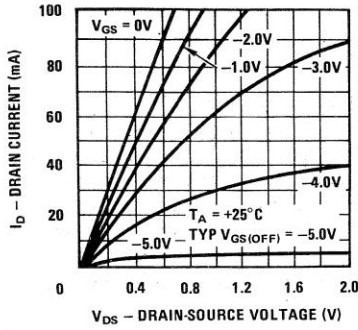

Parameter Interactions

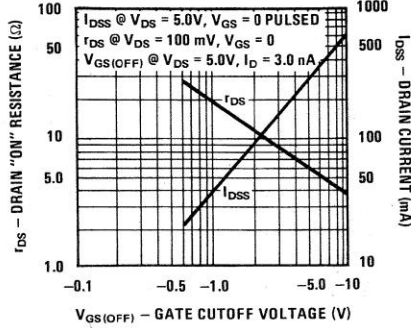

"ON" Resistance vs Drain Current

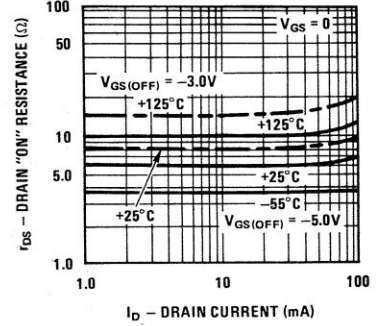

Common Drain-Source Characteristics

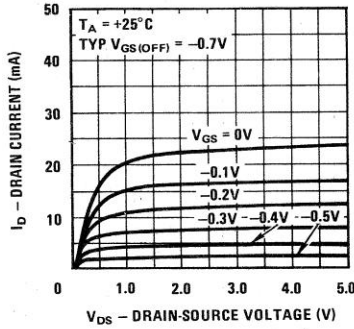

Normalized Drain Resistance vs Bias Voltage

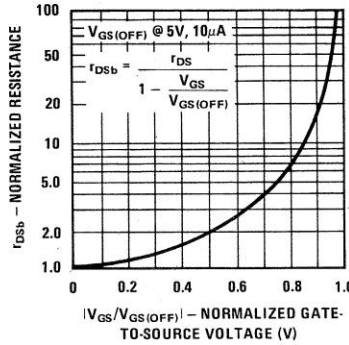

Leakage Current vs Voltage

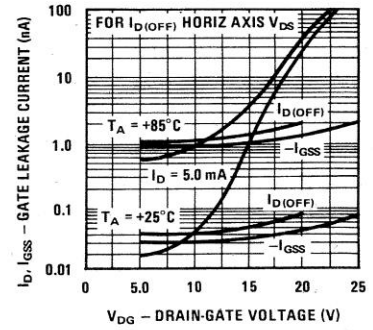

Output Conductance vs Drain Current

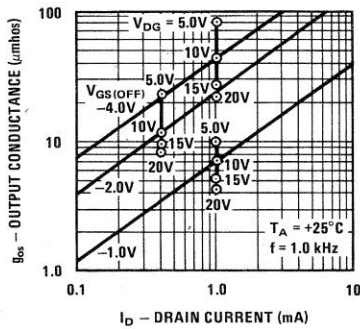

Transconductance vs Drain Current

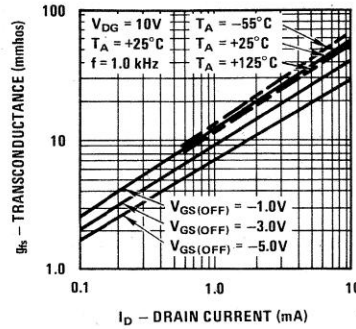

Noise Voltage vs Frequency

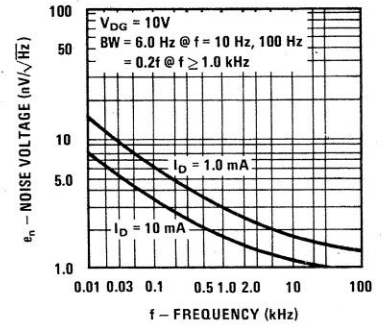

Capacitance vs Voltage

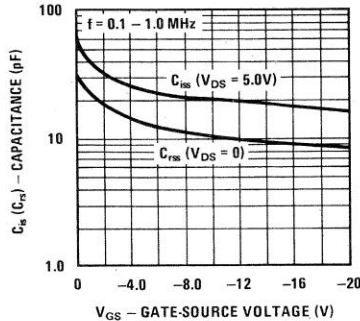

Switching Turn-On vs Gate-Source Voltage

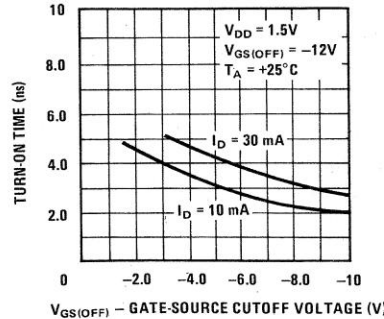

Switching Turn-On Time vs Drain Current

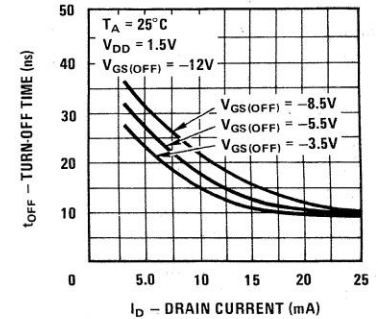

Process 59 N-Channel JFET

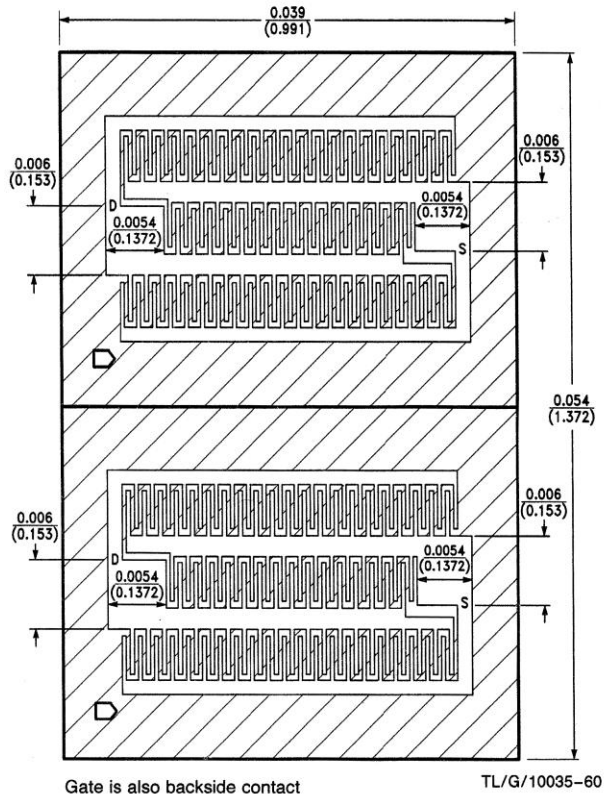

DESCRIPTION

Process 59 is provided for analog or digital switching applications where very low $R_{DS(ON)}$ is mandatory. The 4Ω typical ON resistance is very useful where switch resistance must be held to an absolute minimum.

Electrical Characteristics ($T_A = 25^\circ\text{C}$)

Symbol	Parameter	Conditions	Min	Typ	Max	Units
BV_{GSS}	Gate-Source Breakdown Voltage	$V_{DS} = 0V, I_G = -1\mu A$	25			V
I_{DSS}	Zero Gate Voltage Drain Current	$V_{DS} = 15V, V_{GS} = 0V$ Pulse Test	100	600	1500	mA
I_{GSS}	Reverse Gate Leakage	$V_{GS} = -15V, V_{DS} = 0V$			1.0	nA
$r_{DS(ON)}$	ON Resistance	$V_{DS} = 100\text{ mV}, V_{GS} = 0V$	1.5	4.0	10	Ω
$V_{GS(OFF)}$	Pinch Off Voltage	$V_{DS} = 5V, I_D = 100\text{ nA}$	0.5	5.0	10	V
$I_{D(OFF)}$	Drain OFF Current	$V_{DS} = 5V, V_{GS} = -10V$		1.0	10	nA
C_{rss}	Feedback Capacitance	$V_{DG} = 15V, I_D = 2\text{ mA}, f = 1\text{ MHz}$		25	35	pF
C_{iss}	Input Capacitance	$V_{DG} = 15V, I_D = 2\text{ mA}, f = 1\text{ MHz}$		50	80	pF
g_{fs}	Forward Transconductance	$V_{DG} = 10V, I_D = 2\text{ mA}$		10		mmho
g_{os}	Output Conductance	$V_{DG} = 10V, I_D = 2\text{ mA}$		200		μmho
e_n	Noise Voltage	$V_{DG} = 15V, I_D = 2\text{ mA}, f = 100\text{ Hz}$		6.0		$\text{nV}/\sqrt{\text{Hz}}$

This process is available in the following device types.

J105
J106
J107

Process 83 N-Channel JFET

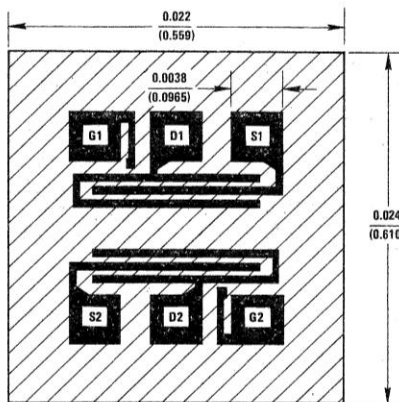

DESCRIPTION

Process 83 is a monolithic dual JFET with a diode isolated substrate. It is intended for operational amplifier input buffer applications. Processing results in low input bias current and virtually unmeasurable offset current. Likewise matching characteristics are virtually independent of operating current and voltage, providing design flexibility. Most GP 2N types are sorted from this family.

CHARACTERISTIC	PARAMETER	TEST CONDITIONS	MIN	TYP	MAX	UNITS
Gate-Source Breakdown Voltage	BV_{GSS}	$V_{DS} = 0V, I_G = -1 \mu A$	-50	-70		V
Zero Gate Voltage Drain Current	I_{DSS}	$V_{DS} = 15V, V_{GS} = 0$	0.5	2.5	8.0	mA
Forward Transconductance	g_{fs}	$V_{DS} = 15V, V_{GS} = 0$	1.0	2.5	5.0	mmho
Pinch Off Voltage	$V_{GS(OFF)}$	$V_{DS} = 15V, I_D = 1 nA$	-0.5	-2.0	-4.5	V
Gate Current	I_G	$V_{DG} = 20V, I_D = 0.2 mA$		3.0	50	pA
Forward Transconductance	g_{fs}	$V_{DG} = 15V, I_D = 0.2 mA$	600	850		$\mu mhos$
Output Conductance	g_{os}	$V_{DG} = 15V, I_D = 0.2 mA$		1.0	5.0	$\mu mhos$
"ON" Resistance	r_{DS}	$V_{DS} = 100 mV, V_{GS} = 0$		450		Ω
Noise Voltage	e_n	$V_{DG} = 15V, I_D = 0.2 mA$ $f = 100 Hz$		10	50	nV/\sqrt{Hz}
Differential Match	$ V_{GS1} - V_{GS2} $	$V_{DG} = 15V, I_D = 0.2 mA$		7.0	25	mV
Differential Match	ΔV_{GS1-2}	$V_{DG} = 15V, I_D = 0.2 mA$		10	50	$\mu V/^\circ C$
Common Mode Rejection	CMRR	$V_{DG} = 15V, I_D = 0.2 mA$	80	95		dB
Feedback Capacitance	C_{rs}	$V_{DG} = 15V, I_D = 0.2 mA,$ $f = 1 MHz$		1.0	1.2	pF
Input Capacitance	C_{is}	$V_{DG} = 15V, I_D = 0.2 mA,$ $f = 1 MHz$		3.4	4.0	pF

Examples of process 83 part numbers are as follows. *Denotes preferred parts.

2N3921	2N5047	U233	J410
2N3922	*2N5196	U234	J411
*2N3954	*2N5197	U235	J412
*2N3954A	*2N5198		
*2N3955	*2N5199		*NPD8301
*2N3955A	2N5452		*NPD8302
*2N3956	2N5453		*NPD8303
*2N3957	2N5454		
*2N3958	*2N5545		
2N4084	*2N5546		
2N4085	*2N5547		
2N5045	U231		
2N5046	U232		

Process 83

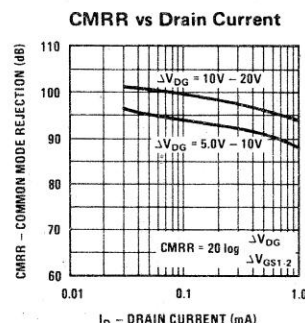
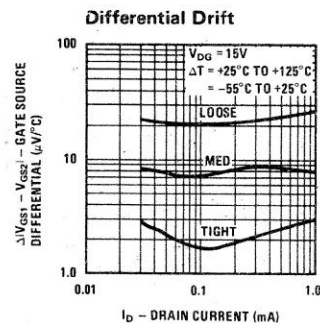
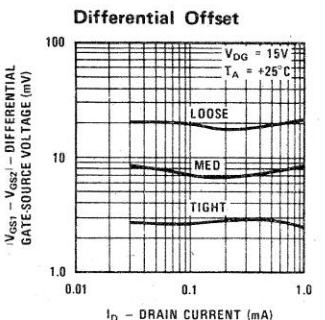
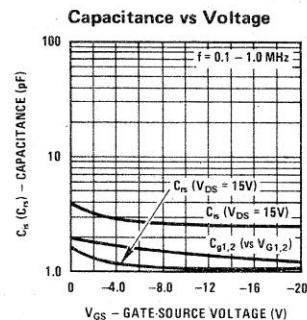
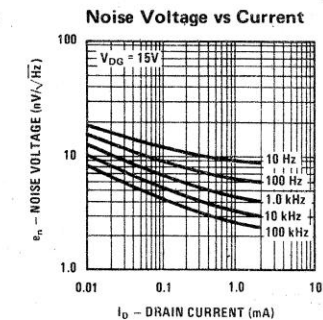
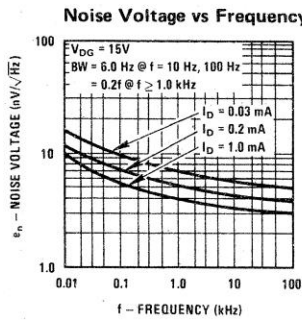
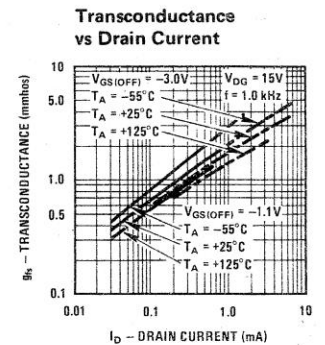
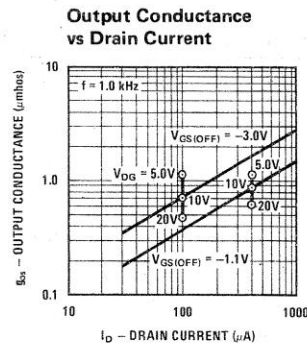
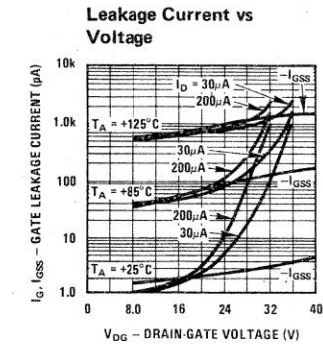
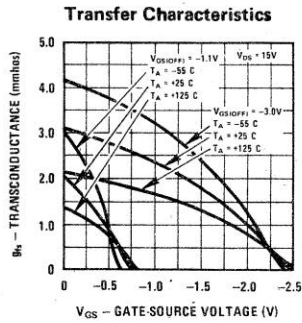
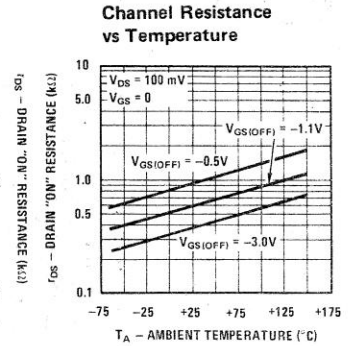
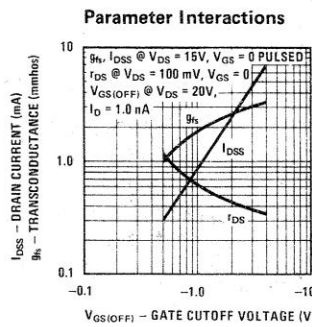
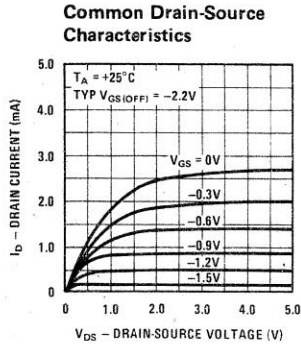
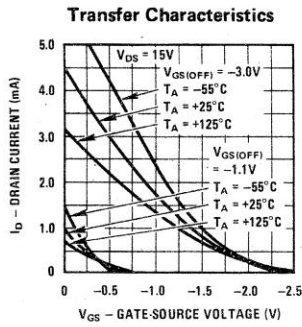

Process 84 N-Channel JFET

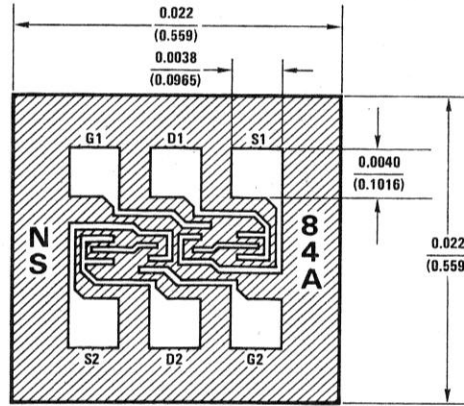

DESCRIPTION

Process 84 is a monolithic dual JFET with a diode isolated substrate. It is designed for the most critical operational amplifier input stages or electrometer single ended preamp. Ideal for medical applications and instrumentation inputs where subpicoamp inputs are important. Device design considered high CMRR, subpicoamp leakage over wide input swings, low capacitance, and tight match over wide current range.

CHARACTERISTIC	PARAMETER	CONDITIONS	MIN	TYP	MAX	UNITS
Gate-Source Breakdown Voltage	BV_{GSS}	$V_{DS} = 0V, I_G = -1 \mu A$	-40	-60		V
Drain Saturation Current	I_{DSS}	$V_{DS} = 15V, V_{GS} = 0V$	20	300	1000	μA
Forward Transconductance	g_{fs}	$V_{DS} = 15V, V_{GS} = 0V$	90	180	300	μV
Forward Transconductance	g_{fs}	$V_{DS} = 15V, I_D = 30 \mu A$	50	120	150	μV
Gate Cutoff Voltage	$V_{GS(OFF)}$	$V_{DS} = 15V, I_D = 1 nA$	0.5	2	4.5	V
Reverse Gate Leakage Current	I_{GSS}	$V_{DS} = 0V, V_{GS} = -20V$		1	5	pA
Gate Leakage Current	I_G	$V_{DG} = 10V, I_D = 30 \mu A$		0.5	3	pA
Feedback Capacitance	C_{rss}	$V_{DS} = 15V, V_{GS} = 0, f = 1 MHz$		0.3	0.4	pF
Input Capacitance	C_{iss}	$V_{DS} = 15V, V_{GS} = 0, f = 1 MHz$		2	3	pF
Noise Voltage	e_n	$V_{DS} = 15V, I_D = 30 \mu A, f = 1 kHz$		30	50	nV/\sqrt{Hz}
Noise Voltage	e_n	$V_{DS} = 15V, I_D = 30 \mu A, f = 10 Hz$		180		nV/\sqrt{Hz}
Output Conductance	g_{os}	$V_{DS} = 10V, I_D = 30 \mu A$		0.1	0.2	μV
Differential Gate-Source Voltage	$ V_{GS1} - V_{GS2} $	$V_{DS} = 10V, I_D = 30 \mu A$		12	25	mV
Differential Gate-Source Voltage Drift	ΔV_{GS1-2}	$V_{DS} = 10V, I_D = 30 \mu A$		10	50	$\mu V/^\circ C$
Common-Mode Rejection Ratio	CMRR	$V_{DS} = 10V, I_D = 30 \mu A$		112		dB

Examples of process 84 part numbers are as follows.

* Denotes preferred parts.

- 2N5902
- 2N5903
- 2N5904
- 2N5905

- *2N5906
- *2N5907
- *2N5908
- *2N5909

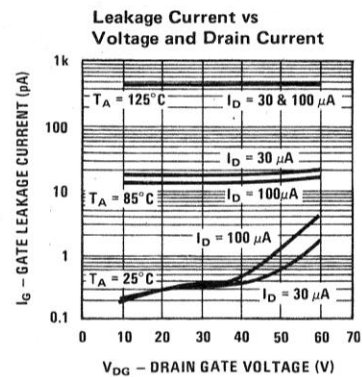
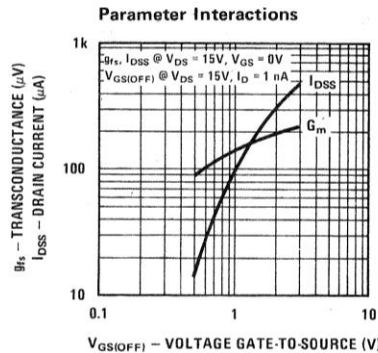

Process 84

Transfer Characteristics

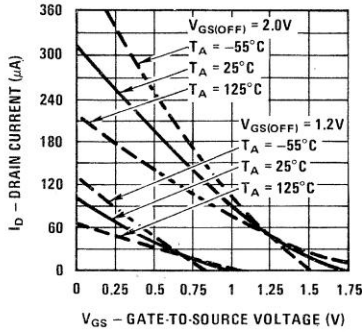

Common Drain-Source Characteristics

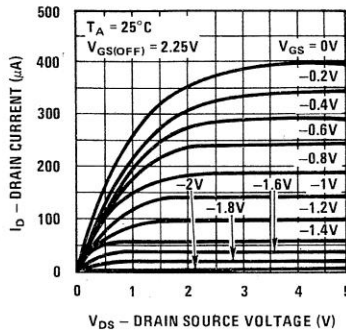

Leakage Current vs Voltage

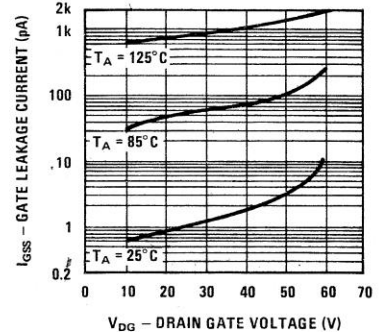

Transfer Characteristics

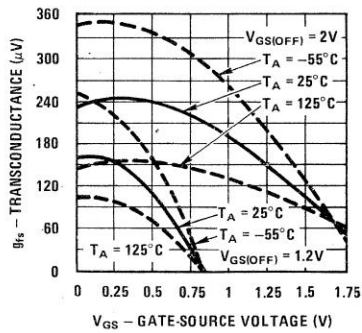

Transconductance vs Drain Current

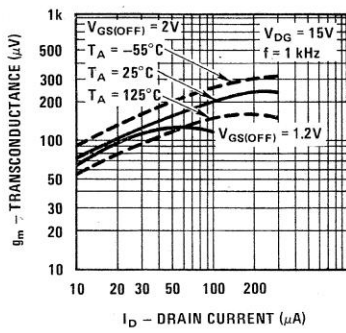

Output Conductance vs Drain Current

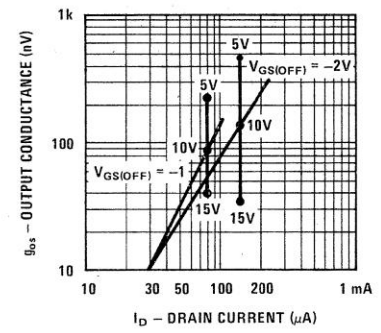

Noise Voltage vs Frequency

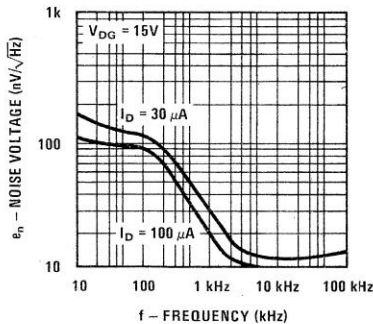

Noise Voltage vs Current

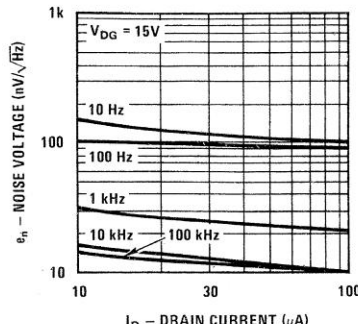

Capacitance vs Voltage

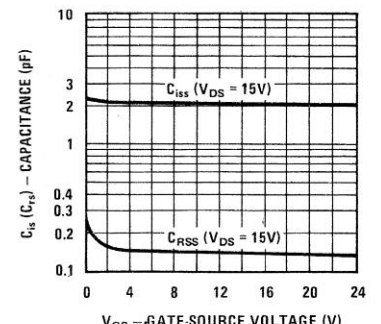

Differential Offset

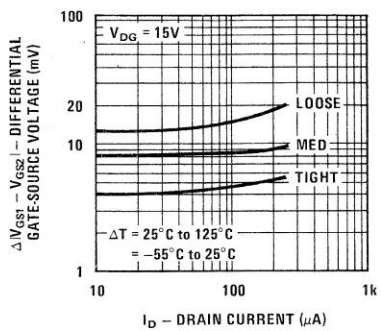

Differential Drift

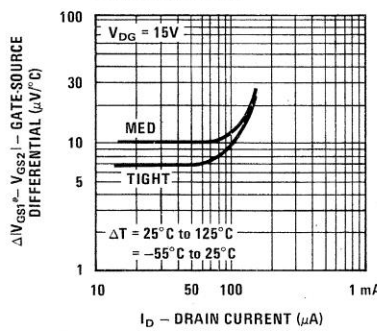

CMRR vs Drain Current

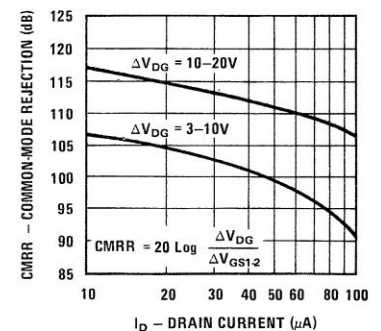

Process 86 Monolithic Dual JFET

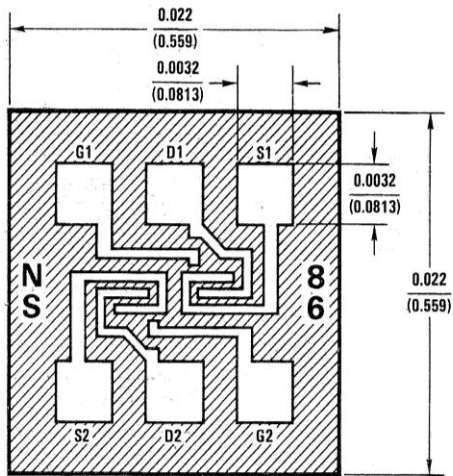

DESCRIPTION

Process 86 is a monolithic dual JFET with a diode isolated substrate. It is intended for critical amplifier input stages requiring low noise, sub picoamp bias currents and high gain. Exacting process control results in consistent parameter distribution with tight match and low drift.

This process is available in the following device types.
* Denotes preferred parts.

U421
U422
U423
U424
U425
U426

Process 88 P-Channel JFET

DESCRIPTION

Process 88 is designed primarily for electronic switching applications where a P channel device is desirable. Inherent zero offset voltage, low leakage and low $R_{DS(ON)}$ C_{iss} time constant make this device excellent for low level analog switching, sample and hold circuits and chopper stabilized amplifiers. This device is the complement to Process 51.

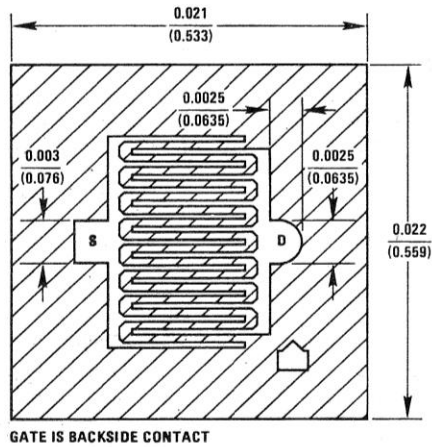

CHARACTERISTIC	PARAMETER	TEST CONDITIONS	MIN	TYP	MAX	UNITS
Gate-Source Breakdown Voltage	BV_{GSS}	$V_{DS} = 0V, I_G = 1 \mu A$	30	40		V
Zero Gate Voltage Drain Current	I_{DSS}	$V_{DS} = -15V, V_{GS} = 0$	-5.0	-30	-90	mA
Forward Transconductance	g_{fs}	$V_{DS} = -15V, V_{GS} = 0$	4.0	13	17	mmhos
Forward Transconductance	g_{fs}	$V_{DG} = -15V, I_D = -2 mA$		3.5		mmhos
Gate Leakage	I_{GSS}	$V_{GS} = 20V, V_{DS} = 0$		0.05	1.0	nA
"ON" Resistance	r_{DS}	$V_{DS} = -100 mV, V_{GS} = 0$	50	80	200	Ω
Pinch Off Voltage	$V_{GS(OFF)}$	$V_{DS} = -15V, I_D = -1 nA$	0.5	5.0	10	V
Drain "OFF" Current	$I_{D(OFF)}$	$V_{DS} = -15V, V_{GS} = 10V$		-0.05	-10	nA
Feedback Capacitance	C_{rss}	$V_{DG} = -15V, I_D = -2 mA, f = 1 MHz$		4.0	5.0	pF
Input Capacitance	C_{iss}	$V_{DS} = -15V, I_D = -2 mA, f = 1 MHz$		14	15	pF
Output Conductance	g_{os}	$V_{DG} = -15V, I_D = -2 mA$		100	300	$\mu mhos$
Noise Voltage	e_n	$V_{DG} = -15V, I_D = -2 mA, f = 100 Hz$		20		nV/\sqrt{Hz}

This process is available in the following device types. * Denotes preferred parts.

- | | | |
|---------|---------|-------|
| 2N2609 | 2N3382 | *J174 |
| 2N4382 | 2N3384 | *J175 |
| 2N5018 | 2N3386 | *J176 |
| 2N5019 | 2N3993 | *J177 |
| *2N5114 | 2N3993A | *J270 |
| *2N5115 | 2N3994 | *J271 |
| *2N5116 | 2N3994A | |
| U300 | | |
| U301 | | |
| U304 | P1086E | |
| U305 | P1087E | |
| U306 | PN4343 | |

QUALIFIED PER MIL-S-19500
 *2N5114JAN, JANTX, JANTXV
 *2N5115JAN, JANTX, JANTXV
 *2N5116JAN, JANTX, JANTXV

Process 88

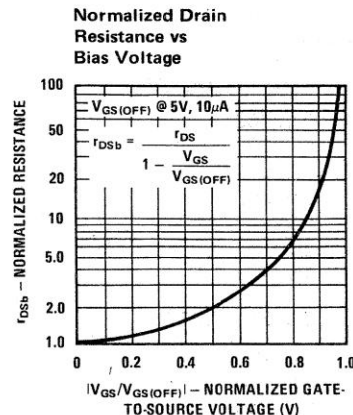
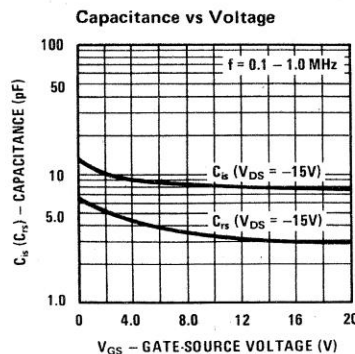
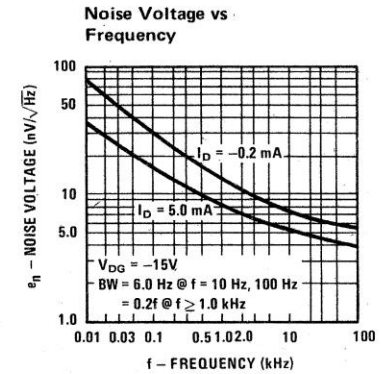
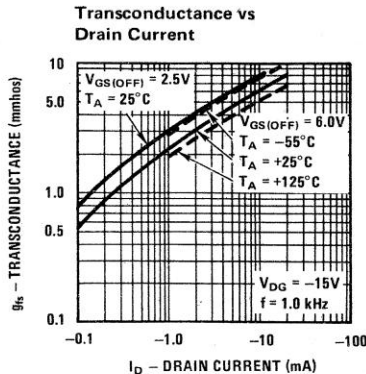
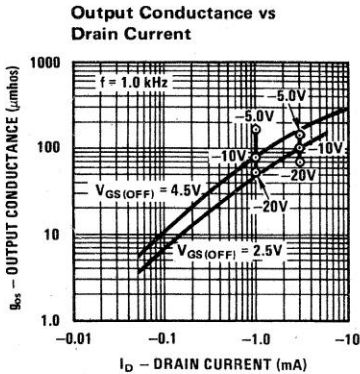
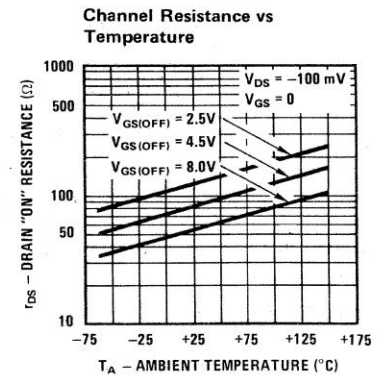
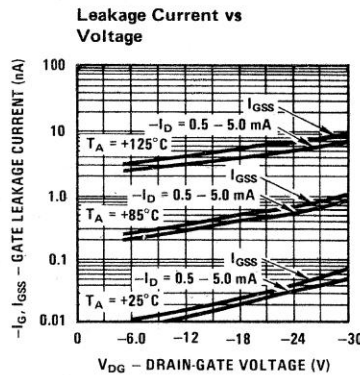
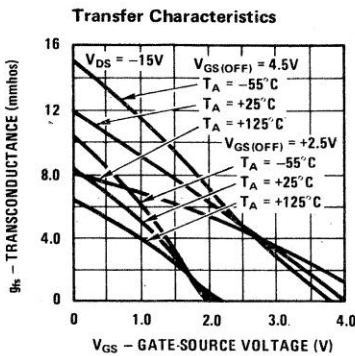
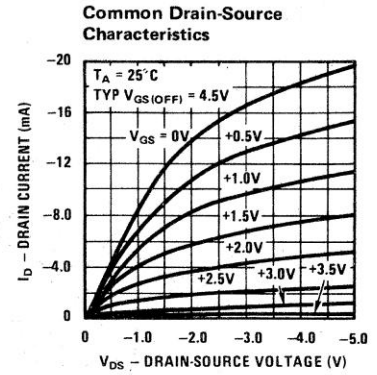
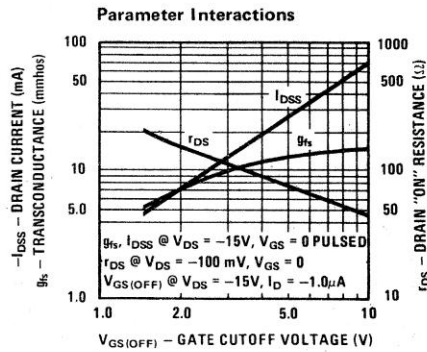
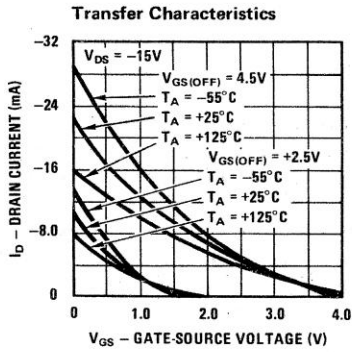

Process 89 P-Channel JFET

DESCRIPTION

Process 89 is designed primarily for low level amplifier applications. This device is the complement to Process 55. Commonly used in voltage variable resistor applications.

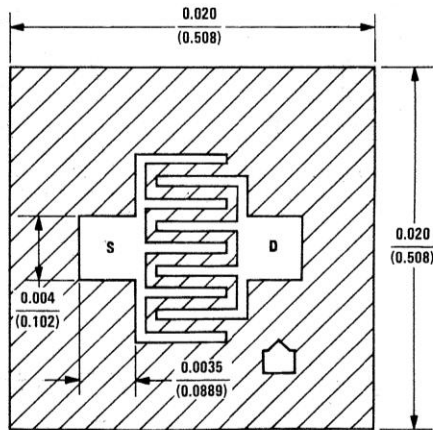

GATE IS BACKSIDE CONTACT

CHARACTERISTIC	PARAMETER	TEST CONDITIONS	MIN	TYP	MAX	UNITS
Gate-Source Breakdown Voltage	BV_{GSS}	$V_{DS} = 0V, I_G = 1 \mu A$	20	40		V
Zero Gate Voltage Drain Current	I_{DSS}	$V_{DS} = -15V, V_{GS} = 0$	-0.3	-4.0	-20	mA
Forward Transconductance	g_{fs}	$V_{DS} = -15V, V_{GS} = 0$	1.0	2.5	4.0	mmhos
Forward Transconductance	g_{fs}	$V_{DG} = -15V, I_D = -0.2 mA$		700		$\mu mhos$
Gate Leakage	I_{GSS}	$V_{GS} = 20V, V_{DS} = 0$		0.02	1.0	nA
Pinch Off Voltage	$V_{GS(OFF)}$	$V_{DS} = -15V, I_D = -1 nA$	0.5	3.0	9.0	V
Feedback Capacitance	C_{rss}	$V_{DG} = -15V, V_{GS} = 0, f = 1 MHz$		2.0	2.5	pF
Input Capacitance	C_{is}	$V_{DS} = -15V, I_D = -2 mA, f = 1 MHz$		7.0	8.5	pF
"ON" Resistance	r_{DS}	$V_{DS} = -100 mV, V_{GS} = 0$		450		Ω
Output Conductance	g_{os}	$V_{DG} = -15V, I_D = -0.2 mA$		5.0	15	$\mu mhos$
Noise Voltage	e_n	$V_{DG} = -15V, I_D = -0.2 mA, f = 100 Hz$		30		nV/\sqrt{Hz}

This process is available in the following device types. *Denotes preferred parts.

2N2608
 2N4381
 2N5020
 2N5021

 2N3329
 2N3330
 2N3331
 2N3332

*2N5460
 *2N5461
 *2N5462
 PN4342
 PN4360
 PN5033

2N3820

QUALIFIED PER MIL-S-19500

2N2608JAN

Process 89

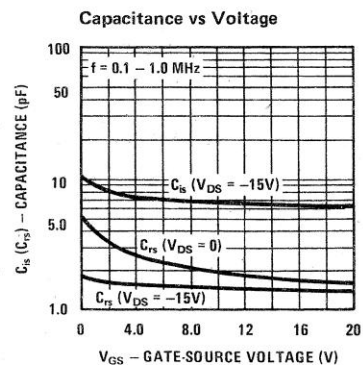
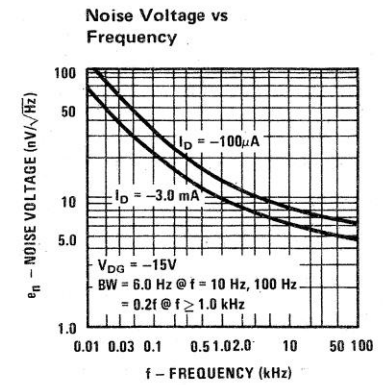
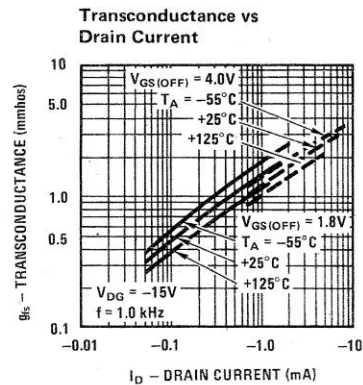
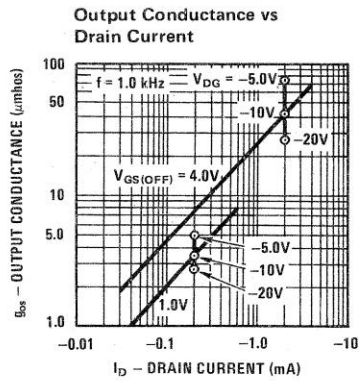
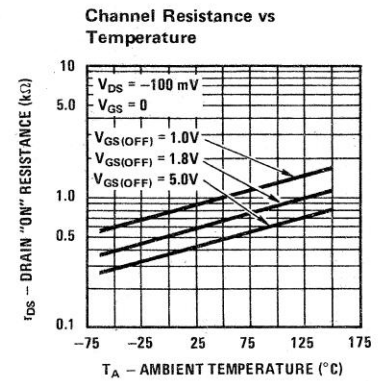
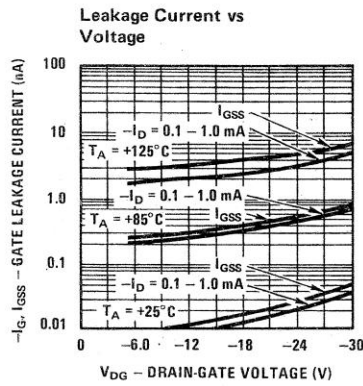
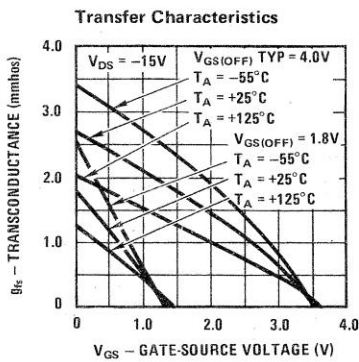
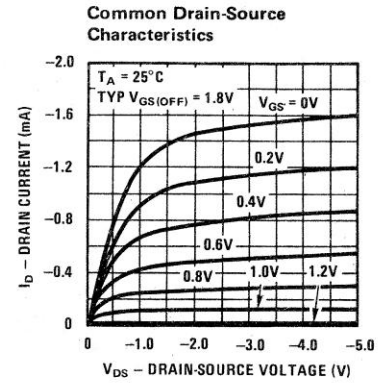
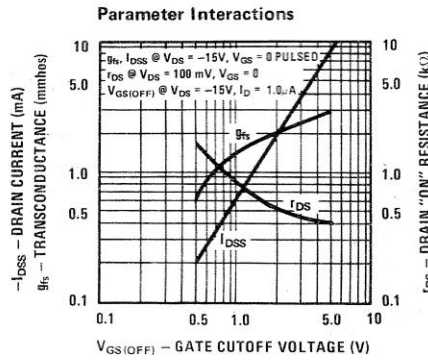
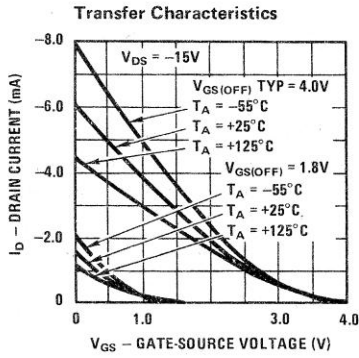

Process 90 P-Channel JFET

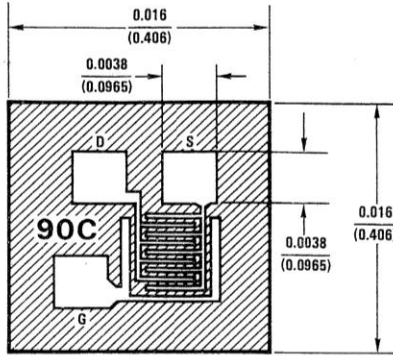

GATE IS ALSO BACKSIDE CONTACT

DESCRIPTION

Process 90 is designed for VHF/UHF mixer/amplifier and applications where Process 50 is not adequate. Has sufficient gain and low noise, common gate configuration at 450 MHz, for sensitive receivers. The high transconductance and square law characteristics insures low crossmodulation and intermodulation distortions. Common-gate operation simplifies circuitry. Consider Process 92 for even higher performance.

CHARACTERISTIC	PARAMETER	TEST CONDITIONS	MIN	TYP	MAX	UNITS
Gate-Source Breakdown Voltage	BV_{GSS}	$V_{DS} = 0V, I_G = -1 \mu A$	-20	-30		V
Zero Gate Voltage Drain Current	I_{DSS}	$V_{DS} = 10V, V_{GS} = 0$	3	18	40	mA
Forward Transconductance	g_{fs}	$V_{DS} = 10V, V_{GS} = 0$	5.5	8.0	10	mmhos
Forward Transconductance	g_{fs}	$V_{DS} = 10V, I_D = 5 mA$	4.5	5.8		mmhos
Reverse Gate Current	I_{GSS}	$V_{GS} = -15V, V_{DS} = 0$		-5.0	-100	pA
"ON" Resistance	r_{DS}	$V_{DS} = 100 mV, V_{GS} = 0$		90		Ω
Pinch Off Voltage	$V_{GS(OFF)}$	$V_{DS} = 10V, I_D = 1 nA$	-1.5	-3.5	-6.0	V
Output Conductance	g_{os}	$V_{DG} = 10V, I_D = 5 mA$		45	100	$\mu mhos$
Feedback Capacitance	C_{rs}	$V_{DG} = 10V, I_D = 5 mA$		1.0	1.2	pF
Input Capacitance	C_{is}	$V_{DG} = 10V, I_D = 5 mA$		4.0	5.0	pF
Noise Voltage	e_n	$V_{DG} = 10V, I_D = 5 mA, f = 100 Hz$		13		nV/\sqrt{Hz}
Noise Figure	NF	$V_{DG} = 10V, I_D = 5 mA, f = 450 MHz$		3.0		dB
Power Gain	$G_{pg} (CG)$	$V_{DG} = 10V, I_D = 5 mA, f = 450 MHz$		11		dB

This process is available in the following device types.

* Denotes preferred parts.

*2N5397
2N5398
U312

J114
*J210
*J211
*J212
*J300

*2N5245
*2N5246
*2N5247

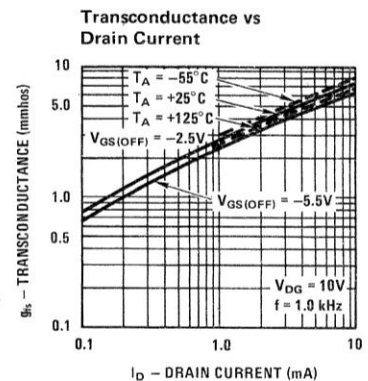
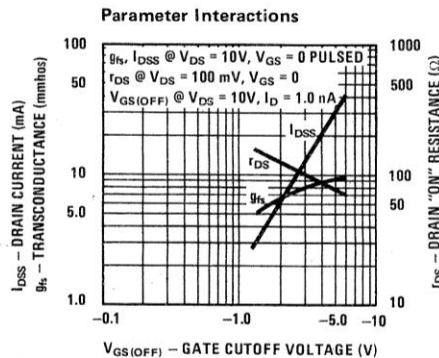
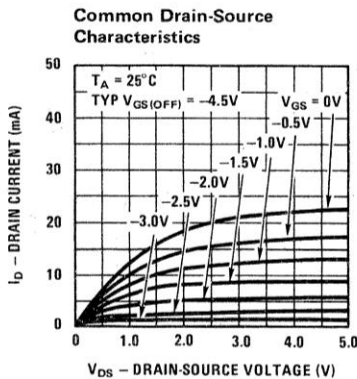

Process 90

COMMON SOURCE

COMMON GATE

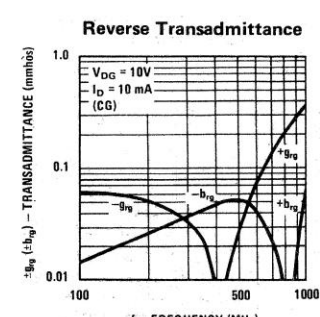
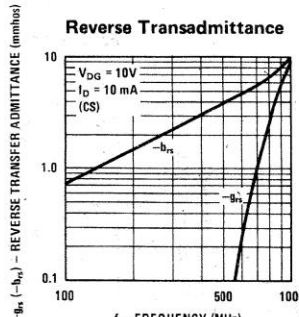
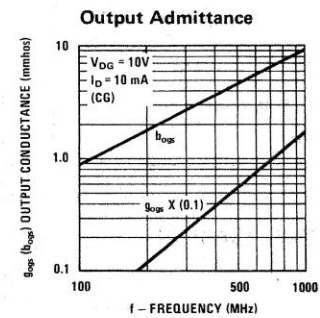
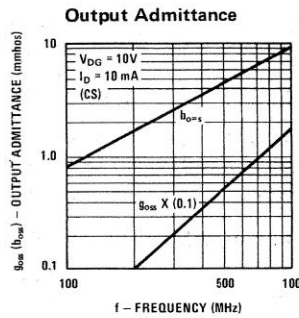
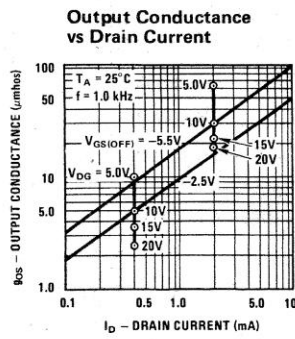
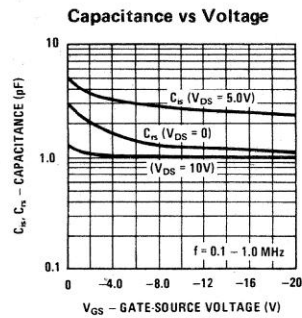
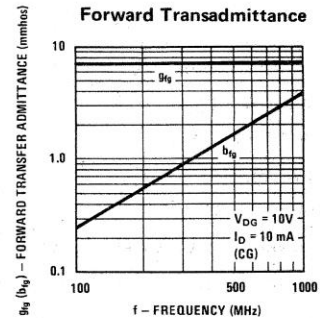
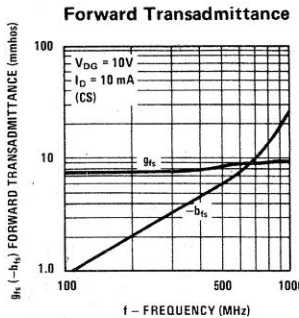
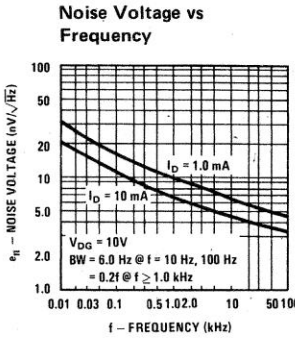
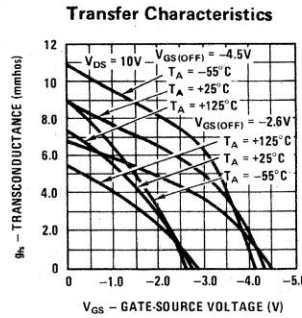
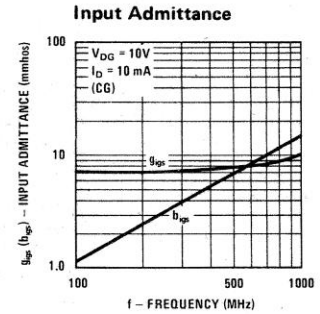
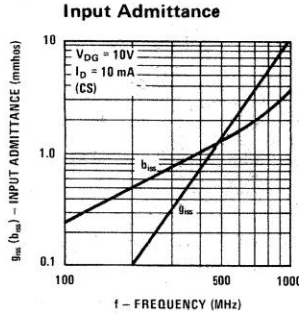
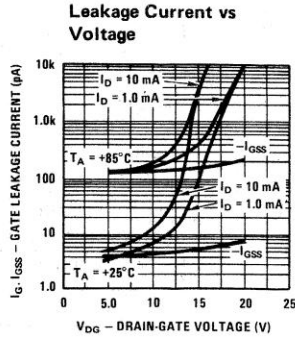
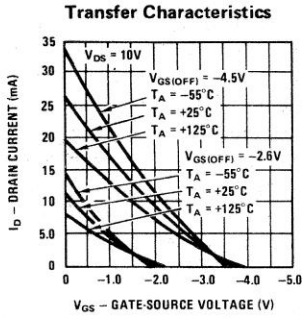

Process 92 N-Channel Junction Match

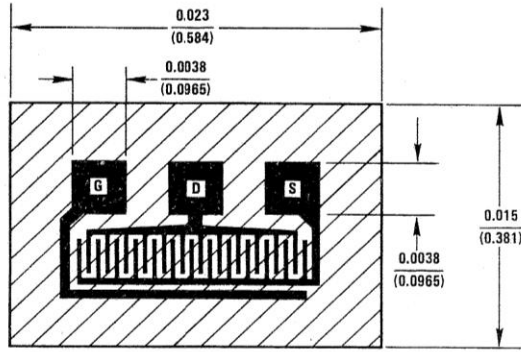

DESCRIPTION

Process 92 is designed for VHF/UHF amplifier, oscillator, and mixer applications. As a common gate amplifier, 16 dB at 100 MHz and 12 dB at 450 MHz can be realized. Worst case 75 ohm input impedance provides ideal input match.

CHARACTERISTIC	PARAMETER	TEST CONDITIONS	MIN	TYP	MAX	UNITS
Gate-Source Breakdown Voltage	BV_{GSS}	$V_{DS} = 0V, I_G = -1 \mu A$	-20	-30		V
Zero Gate Voltage Drain Current	I_{DSS}	$V_{DS} = 10V, V_{GS} = 0$, Pulsed	10	38	80	mA
Forward Transconductance	g_{fs}	$V_{DS} = 10V, V_{GS} = 0$, Pulsed		19		mmhos
Forward Transconductance	g_{fs}	$V_{DG} = 10V, I_D = 10 \text{ mA}$	10	13	18	mmhos
Reverse Gate Current	I_{GSS}	$V_{GS} = -15V, V_{DS} = 0$		-15	-100	pA
"ON" Resistance	r_{DS}	$V_{DS} = 100 \text{ mV}, V_{GS} = 0$	35	45	80	Ω
Pinch Off Voltage	$V_{GS(OFF)}$	$V_{DS} = 10V, I_D = 1 \text{ nA}$	-1.5	-4.0	-6.5	V
Output Conductance	g_{os}	$V_{DG} = 10V, I_D = 10 \text{ mA}$		160	250	μmhos
Feedback Capacitance	C_{gd}	$V_{DG} = 10V, I_D = 10 \text{ mA}, f = 1 \text{ MHz}$		2.0	2.5	pF
Input Capacitance	C_{gs}	$V_{DG} = 10V, I_D = 10 \text{ mA}, f = 1 \text{ MHz}$		4.1	5.0	pF
Noise Voltage	e_n	$V_{DG} = 10V, I_D = 10 \text{ mA}, f = 100 \text{ Hz}$		6.0		$nV/\sqrt{\text{Hz}}$
Noise Figure	NF	$V_{DG} = 10V, I_D = 10 \text{ mA}, f = 450 \text{ MHz}$		3.0		dB
Power Gain	G_{pg}	$V_{DG} = 10V, I_D = 10 \text{ mA}, f = 450 \text{ MHz}$		12		dB

This process is available in the following device types. * Denotes preferred parts.

- | | | |
|-------|------|-------|
| U308 | U430 | J308 |
| *U309 | U431 | *J309 |
| *U310 | | *J310 |

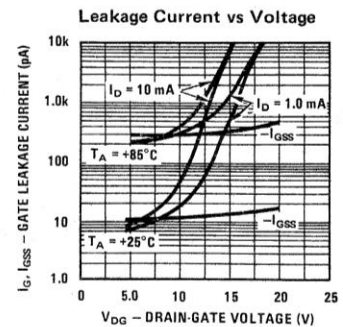
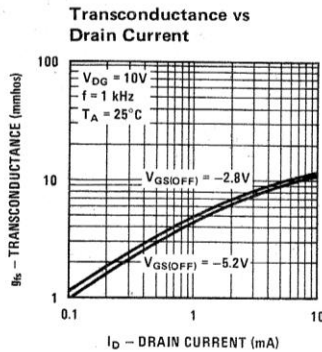
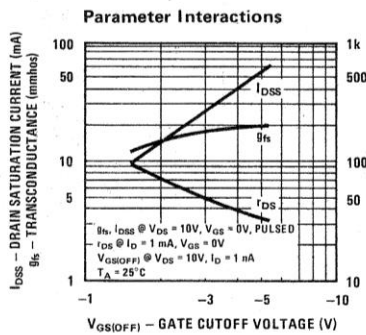

Process 92

Transfer Characteristics

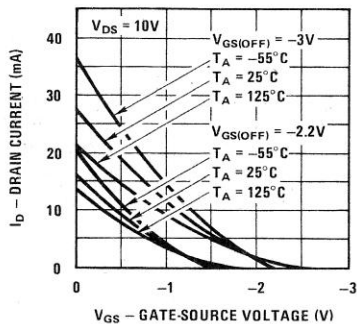

Transfer Characteristics

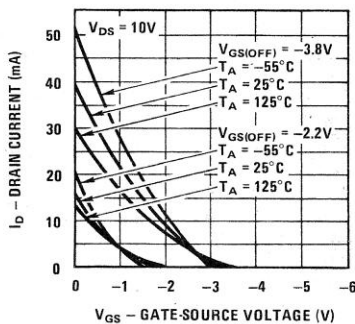

Input Admittance

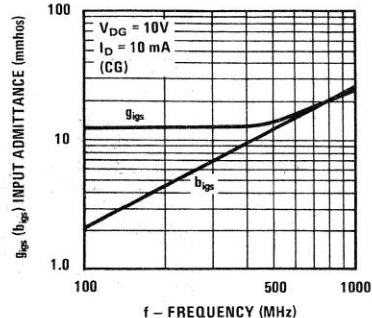

Transfer Characteristics

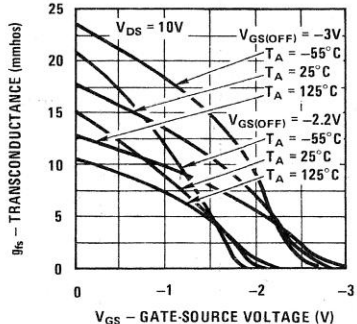

Transfer Characteristics

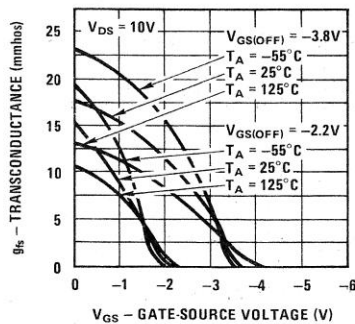

Forward Transadmittance

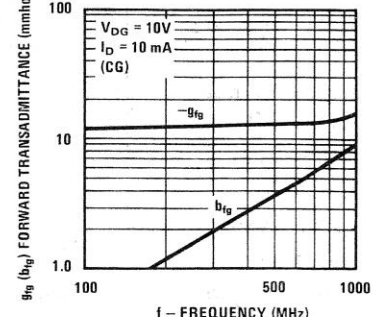

Common Drain-Source Characteristics

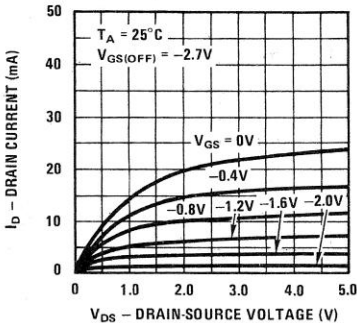

Output Conductance vs Drain Current

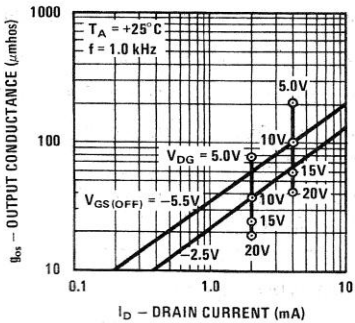

Output Admittance

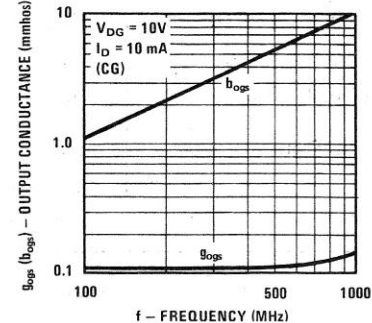

Capacitance vs Voltage

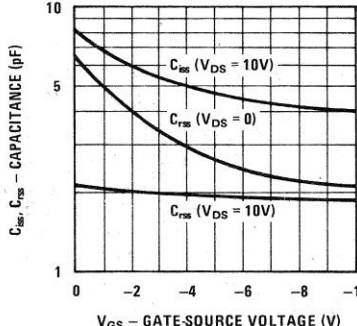

Noise Voltage vs Frequency

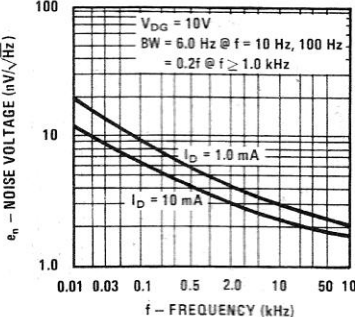

Reverse Transadmittance

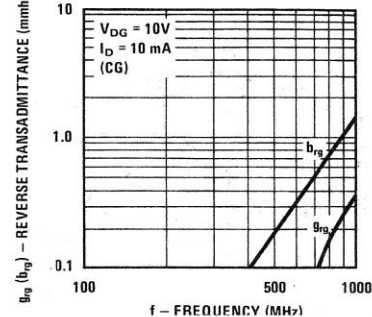

Process 93 N-Channel JFET

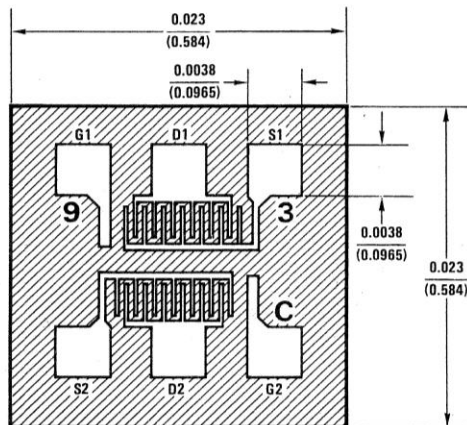

DESCRIPTION

Process 93 is a monolithic dual JFET with a diode isolated substrate. It is intended for wide band, low noise, single ended video amplifier input stages, and high slew rate op amps. Monolithic structure eliminates thermal transient errors, and provides freedom to pick operating current and voltage.

CHARACTERISTIC	PARAMETER	TEST CONDITIONS	MIN	TYP	MAX	UNITS
Gate-Source Breakdown Voltage	BV_{GSS}	$V_{DS} = 0V, I_G = -1 \mu A$	-25	-30		V
Zero Gate Voltage Drain Current	I_{DSS}	$V_{DS} = 10V, V_{GS} = 0, \text{ Pulsed}$	3.0	18	40	mA
Forward Transconductance	g_{fs}	$V_{DS} = 10V, V_{GS} = 0, \text{ Pulsed}$		8.0		mmhos
Forward Transconductance	g_{fs}	$V_{DG} = 10V, I_D = 5 \text{ mA}$	5.0	6.0	10	mmhos
Output Conductance	g_{os}	$V_{DG} = 10V, I_D = 5 \text{ mA}$		50	100	μmhos
Pinch Off Voltage	$V_{GS(OFF)}$	$V_{DS} = 10V, I_D = 1 \text{ nA}$	-1.5	-3.5	-6.0	V
"ON" Resistance	r_{DS}	$V_{DS} = 100 \text{ mV}, V_{GS} = 0$		100		Ω
Gate Current	I_G	$V_{DG} = 10V, I_D = 5 \text{ mA}$		10	100	pA
Noise Voltage	e_n	$V_{DG} = 10V, I_D = 5 \text{ mA}, f = 100 \text{ Hz}$		9.0	30	$\text{nV}/\sqrt{\text{Hz}}$
Differential Match	$ V_{GS1} - V_{GS2} $	$V_{DG} = 10V, I_D = 5 \text{ mA}$		9.0	30	mV
Differential Match	ΔV_{GS1-2}	$V_{DG} = 10V, I_D = 5 \text{ mA}$		15	40	$\mu\text{V}/^\circ\text{C}$
Common Mode Rejection	CMRR	$V_{DG} = 10V, I_D = 5 \text{ mA}$		90		dB
Feedback Capacitance	C_{rs}	$V_{DG} = 10V, I_D = 5 \text{ mA}, f = 1 \text{ MHz}$		1.0	1.2	pF
Input Capacitance	C_{is}	$V_{DG} = 10V, I_D = 5 \text{ mA}, f = 1 \text{ MHz}$		4.2	5.0	pF

This process is available in the following device types. * Denotes preferred parts.

- *2N5911
- *2N5912
- U257

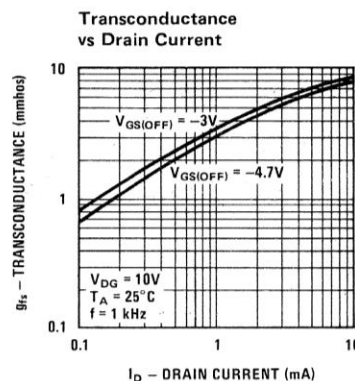
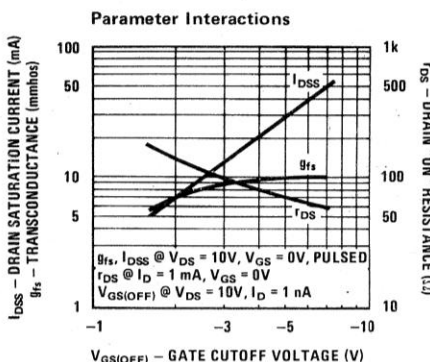

Process 93

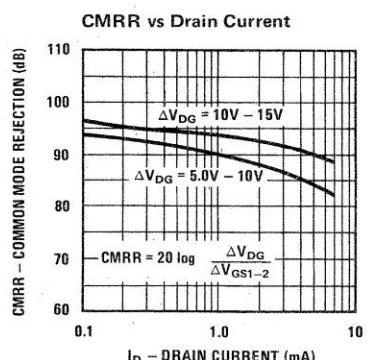
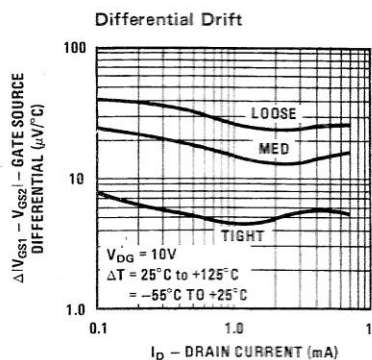
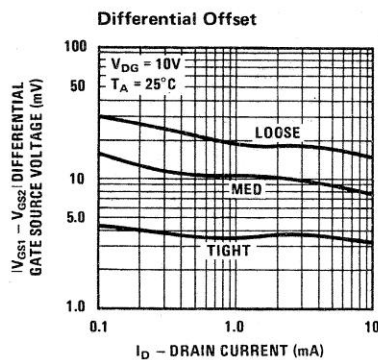
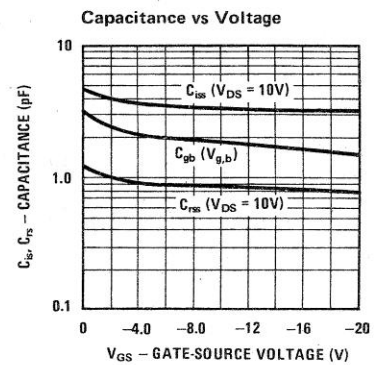
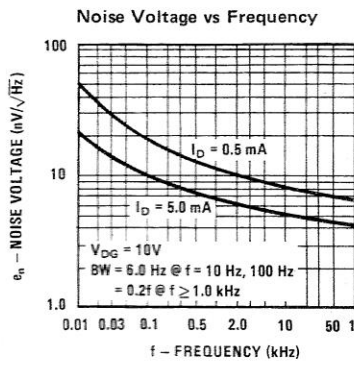
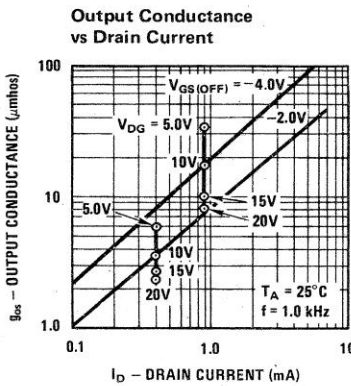
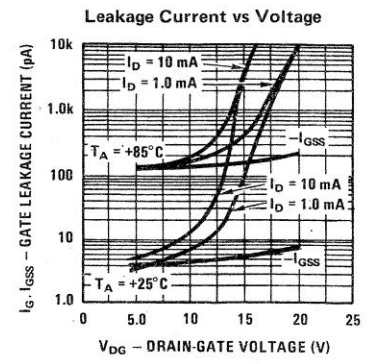
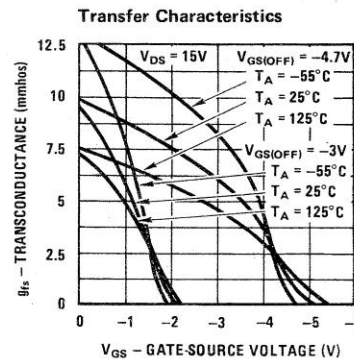
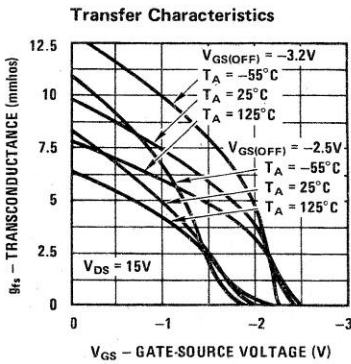
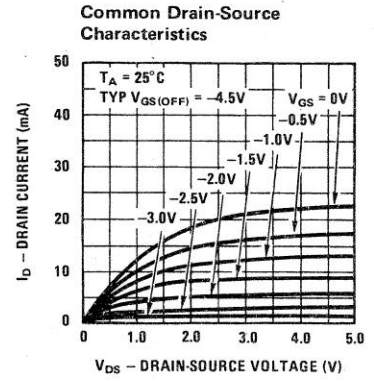
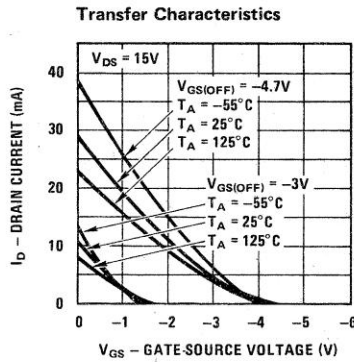
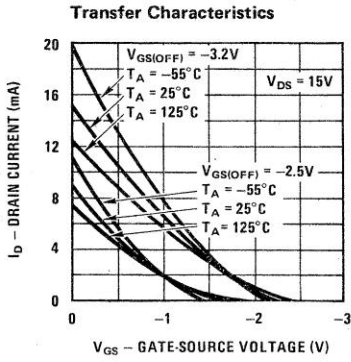

Process 93 P-Channel JFET

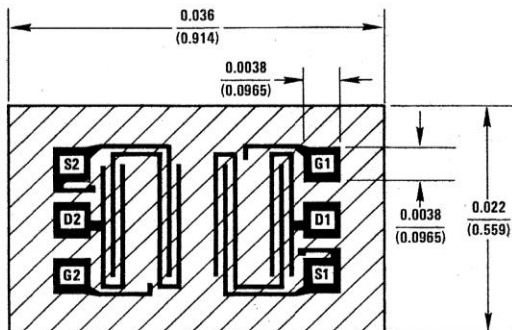

DESCRIPTION

Process 94 is a monolithic dual JFET. It is strictly intended for operational amplifier input buffer applications. Special processing results in extremely low input bias current and virtually unmeasurable offset current. It is important to note that the <5 pico ampere bias current is measured at 35 volts. Typical CMRR is 125 dB. Performance superior to electrometer tubes can be readily achieved with low offset voltage and almost zero long term drift.

CHARACTERISTIC	PARAMETER	TEST CONDITIONS	MIN	TYP	MAX	UNITS
Gate-Source Breakdown Voltage	BV_{GSS}	$V_{DS} = 0V, I_G = -1 \mu A$	-40	-70		V
Zero Gate Voltage Drain Current	I_{DSS}	$V_{DS} = 15V, V_{GS} = 0$	0.5	3.0	10	mA
Forward Transconductance	g_{fs}	$V_{DS} = 15V, V_{GS} = 0$	1.5	3.5	7.0	mmho
Forward Transconductance	g_{fs}	$V_{DG} = 15V, I_D = 0.2 \text{ mA}$	0.9	1.2	1.8	mmhos
Pinch Off Voltage	$V_{GS(OFF)}$	$V_{DS} = 15V, I_D = 1 \text{ nA}$	-0.5	-2.0	-6.0	V
Gate Current	I_G	$V_{DG} = 35V, I_D = 0.20 \text{ mA}$		1.0	15	pA
Feedback Capacitance	C_{rss}	$V_{DS} = 15V, V_{GS} = 0, f = 1 \text{ MHz}$		0.01	0.02	pF
Input Capacitance	C_{iss}	$V_{DS} = 15V, V_{GS} = 0, f = 1 \text{ MHz}$		4.0	5.0	pF
Noise Voltage	e_n	$V_{DG} = 15V, I_D = 0.2 \text{ mA}, f = 10 \text{ Hz}$		12	50	nV/\sqrt{Hz}
Output Conductance	g_{os}	$V_{DG} = 15V, I_D = 0.2 \text{ mA}$		<0.1		μmhos
Differential Match	$ V_{GS1} - V_{GS2} $	$V_{DG} = 15V, I_D = 0.2 \text{ mA}$		5.0	25	mV
Differential Match	ΔV_{GS1-2}	$V_{DG} = 15V, I_D = 0.2 \text{ mA}$		6.0	50	$\mu V/^\circ C$
Common Mode Rejection	CMRR	$V_{DG} = 15V, I_D = 0.2 \text{ mA}$		125		dB

This process is available in the following device types.

* Denotes preferred parts.

- * NDF9406
- * NDF9407
- * NDF9408
- * NDF9409
- * NDF9410

- NDF9401
- NDF9402
- NDF9403
- NDF9404
- NDF9405

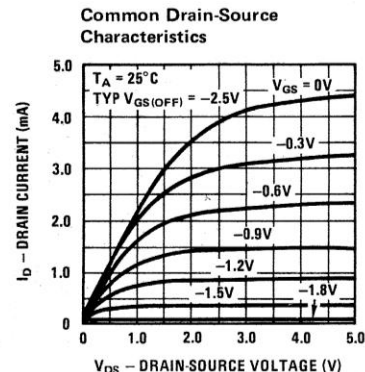
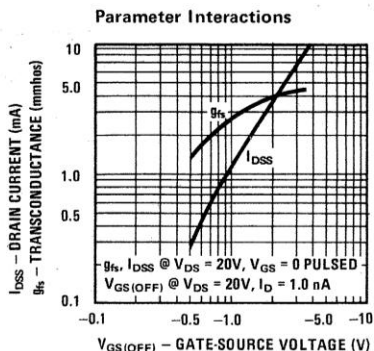

Process 94

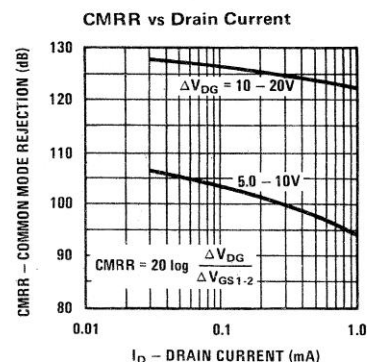
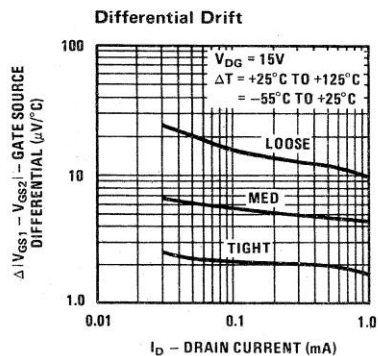
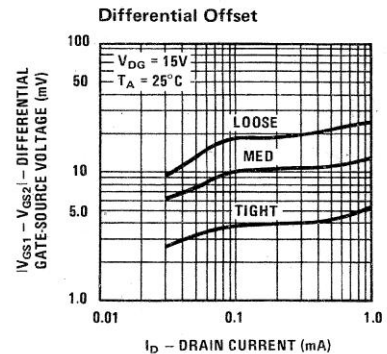
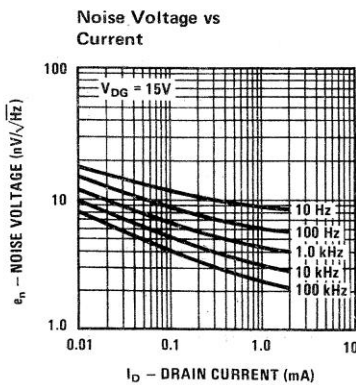
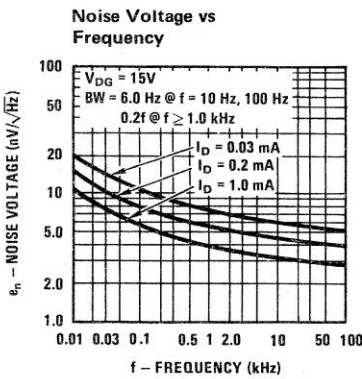
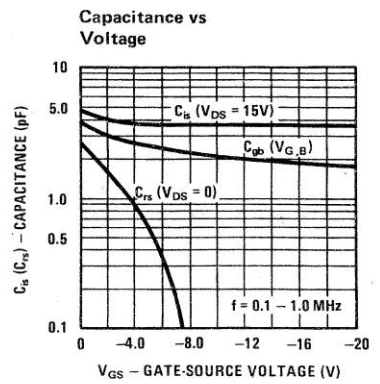
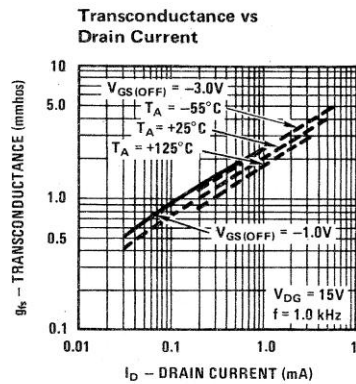
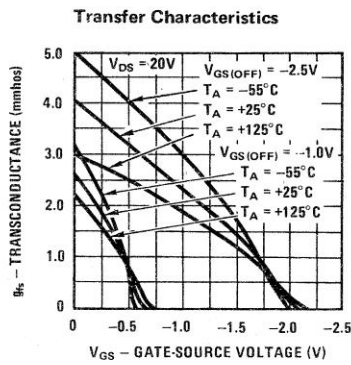
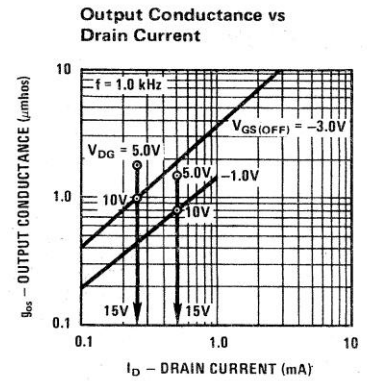
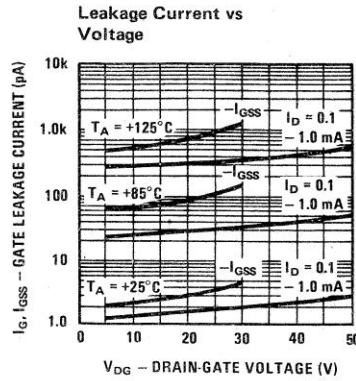
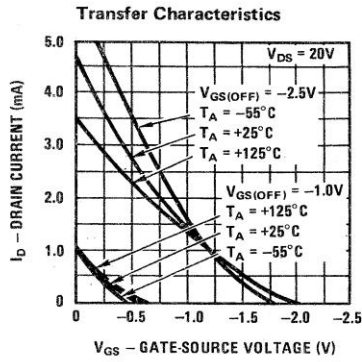

Process 95 N-Channel JFET

DESCRIPTION

Process 95 is a monolithic dual JFET with a diode isolated substrate. It is intended for operational amplifier input buffer applications. Processing results in low input bias current and virtually unmeasurable offset current. Low noise voltage and high CMRR for critical I/f applications.

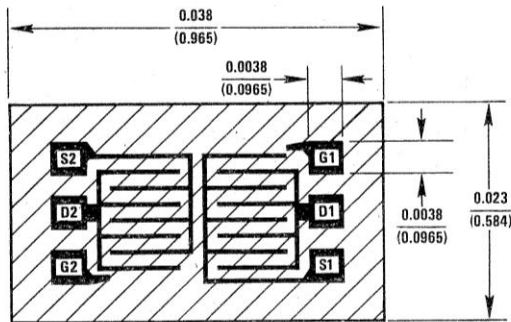

CHARACTERISTIC	PARAMETER	TEST CONDITIONS	MIN	TYP	MAX	UNITS
Gate-Source Breakdown Voltage	BV_{GSS}	$V_{DS} = 0V, I_G = -1 \mu A$	-40	-70		V
Zero Gate Voltage Drain Current	I_{DSS}	$V_{DS} = 15V, V_{GS} = 0$	0.5	3.0	8.0	mA
Forward Transconductance	g_{fs}	$V_{DS} = 15V, V_{GS} = 0$	1.0	2.5	4.0	mmhos
Forward Transconductance	g_{fs}	$V_{DG} = 15V, I_D = 0.2 \text{ mA}$	0.5	0.7		mmhos
Gate Leakage	I_{GSS}	$V_{GS} = -20V, V_{DS} = 0$		-5.0	-100	pA
Pinch Off Voltage	$V_{GS(OFF)}$	$V_{DS} = 15V, I_D = 1 \text{ nA}$	-0.5	-2.5	-4.0	V
Input Capacitance	C_{iss}	$V_{DS} = 15V, V_{GS} = 0, f = 1 \text{ MHz}$		10	14	pF
Noise Voltage	e_n	$V_{DS} = 15V, I_D = 0.2 \text{ mA}, f = 10 \text{ Hz}$		8.0	30	$nV/\sqrt{\text{Hz}}$
Noise Voltage	e_n	$V_{DS} = 15V, I_D = 0.2 \text{ mA}, f = 100 \text{ Hz}$		6.0	10	$nV/\sqrt{\text{Hz}}$
Output Conductance	g_{os}	$V_{DG} = 15V, I_D = 0.2 \text{ mA}$		0.3	1.0	μmhos
Feedback Capacitance	C_{rss}	$V_{DS} = 15V, V_{GS} = 0, f = 1 \text{ MHz}$		3.5	5.0	pF
Differential Match	$ V_{GS1} - V_{GS2} $	$V_{DG} = 20V, I_D = 0.2 \text{ mA}$		6.0	25	mV
Differential Match	ΔV_{GS1-2}	$V_{DG} = 20V, I_D = 0.2 \text{ mA}$		9.0	60	$\mu V/^\circ\text{C}$
Common Mode Rejection	CMRR	$V_{DG} = 20V, I_D = 0.2 \text{ mA}$	86	115		dB

This process is available in the following device types.

2N5515	*2N5522
2N5516	*2N5523
2N5517	*2N5524
2N5518	*2N6483
2N5519	*2N6484
*2N5520	*2N6485
*2N5521	

*Denotes preferred parts.

Process 95

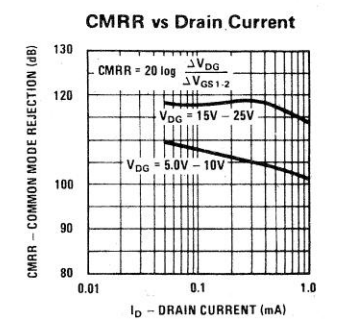
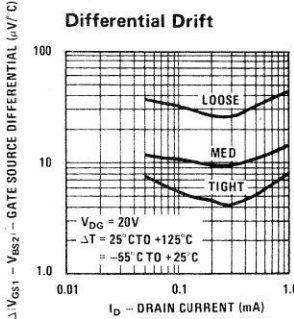
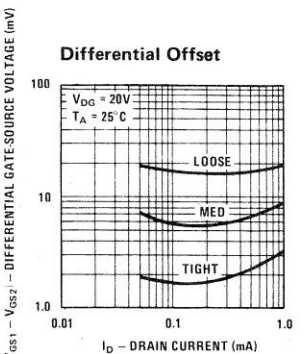
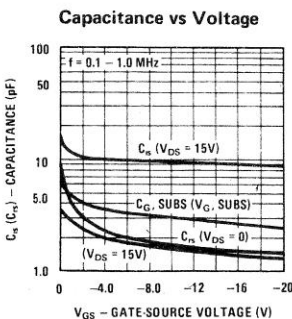
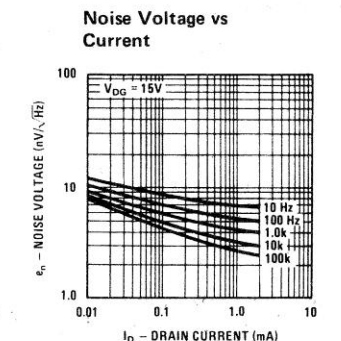
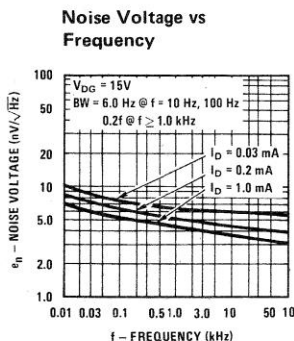
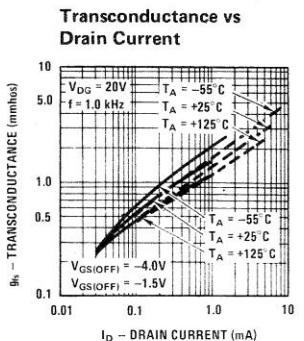
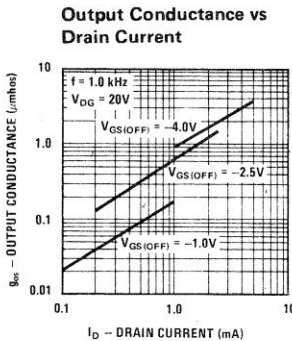
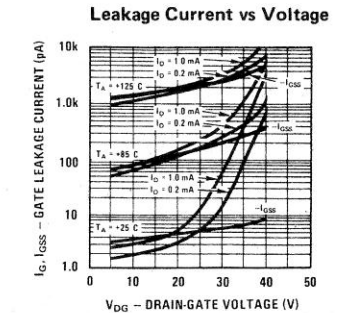
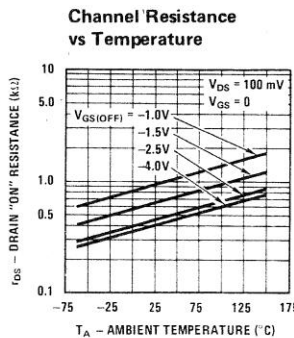
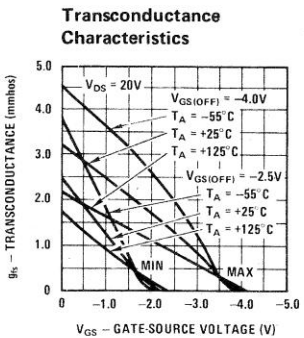
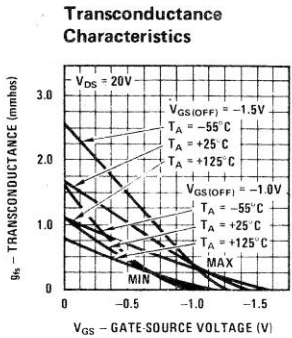
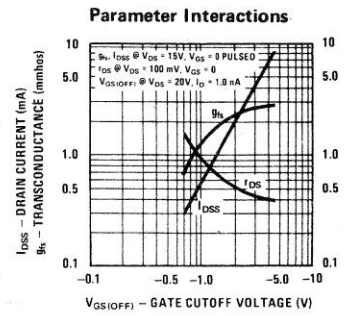
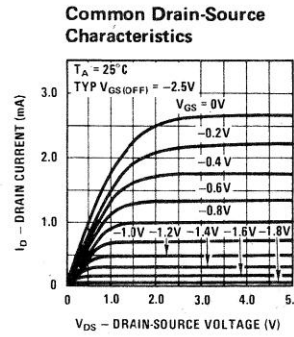
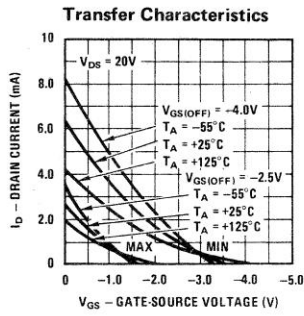
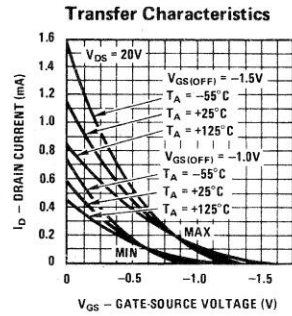

Process 96 N-Channel JFET

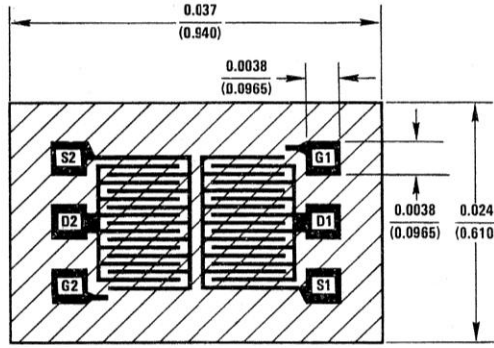

DESCRIPTION

Process 96 is a monolithic dual JFET with a diode isolated substrate. It is intended for wide band, low noise, single ended video amplifier input stages. Also ideal for matched voltage variable resistor applications over 60 dB tracking range.

CHARACTERISTIC	PARAMETER	TEST CONDITIONS	MIN	TYP	MAX	UNITS
Gate-Source Breakdown Voltage	BV_{GSS}	$V_{DS} = 0V, I_G = -1 \mu A$	-40	-55		V
Zero Gate Voltage Drain Current	I_{DSS}	$V_{DS} = 15V, V_{GS} = 0$	5.0	15	30	mA
Forward Transconductance	g_{fs}	$V_{DS} = 15V, V_{GS} = 0$	9.0	18	30	mmhos
Forward Transconductance	g_{fs}	$V_{DG} = 15V, I_D = 2 mA$	7.5	9.0		mmhos
Output Conductance	g_{os}	$V_{DG} = 15V, I_D = 2 mA$		15	45	$\mu mhos$
Pinch Off Voltage	$V_{GS(OFF)}$	$V_{DS} = 15V, I_D = 1 nA$		-1.8	-3.0	V
"ON" Resistance	r_{DS}	$V_{DS} = 100 mV, V_{GS} = 0$	35	70	120	Ω
Gate Current	I_{GSS}	$V_{GS} = -20V, V_{DS} = 0$		-8.0	-100	μA
Gate Current	I_G	$V_{DG} = 15V, I_D = 2 mA$		15	200	μA
Noise Voltage	e_n	$V_{DG} = 15V, I_D = 2 mA, f = 100 Hz$		4.5	10	nV/\sqrt{Hz}
Feedback Capacitance	C_{rs}	$V_{DG} = 15V, I_D = 2 mA, f = 1 MHz$		2.5	3.0	pF
Input Capacitance	C_{is}	$V_{DG} = 15V, I_D = 2 mA, f = 1 MHz$		10	12	pF
Differential Voltage	$ V_{GS1} - V_{GS2} $	$V_{DG} = 15V, I_D = 2 mA$		8.0	25	mV
Differential Voltage	ΔV_{GS}	$V_{DG} = 15V, I_D = 2 mA$		9.0	50	$\mu V/^\circ C$
Common Mode Rejection	CMRR	$V_{DG} = 15V, I_D = 2 mA$	76	95		dB

This process is available in the following device types. *Denotes preferred parts.

- *2N5564
- *2N5565
- *2N5566
- *NPD5564
- *NPD5565
- *NPD5566

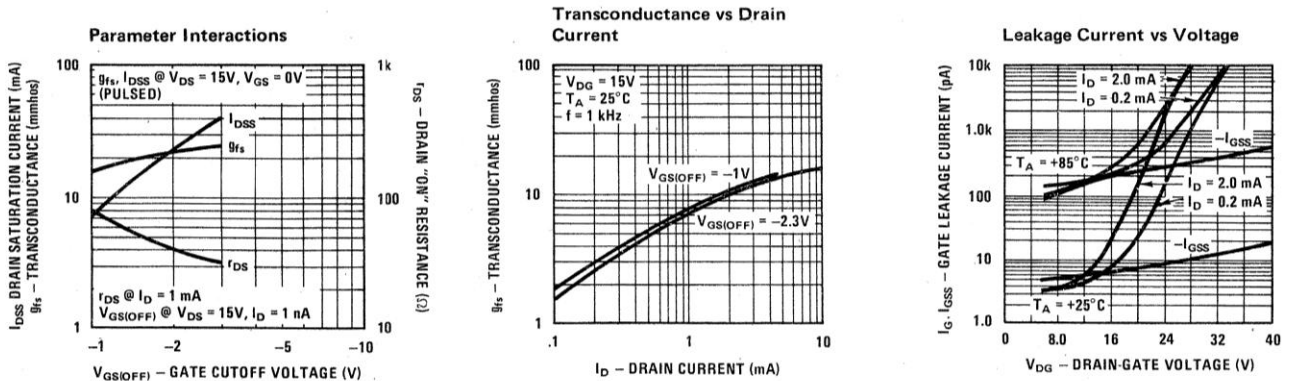

Process 96

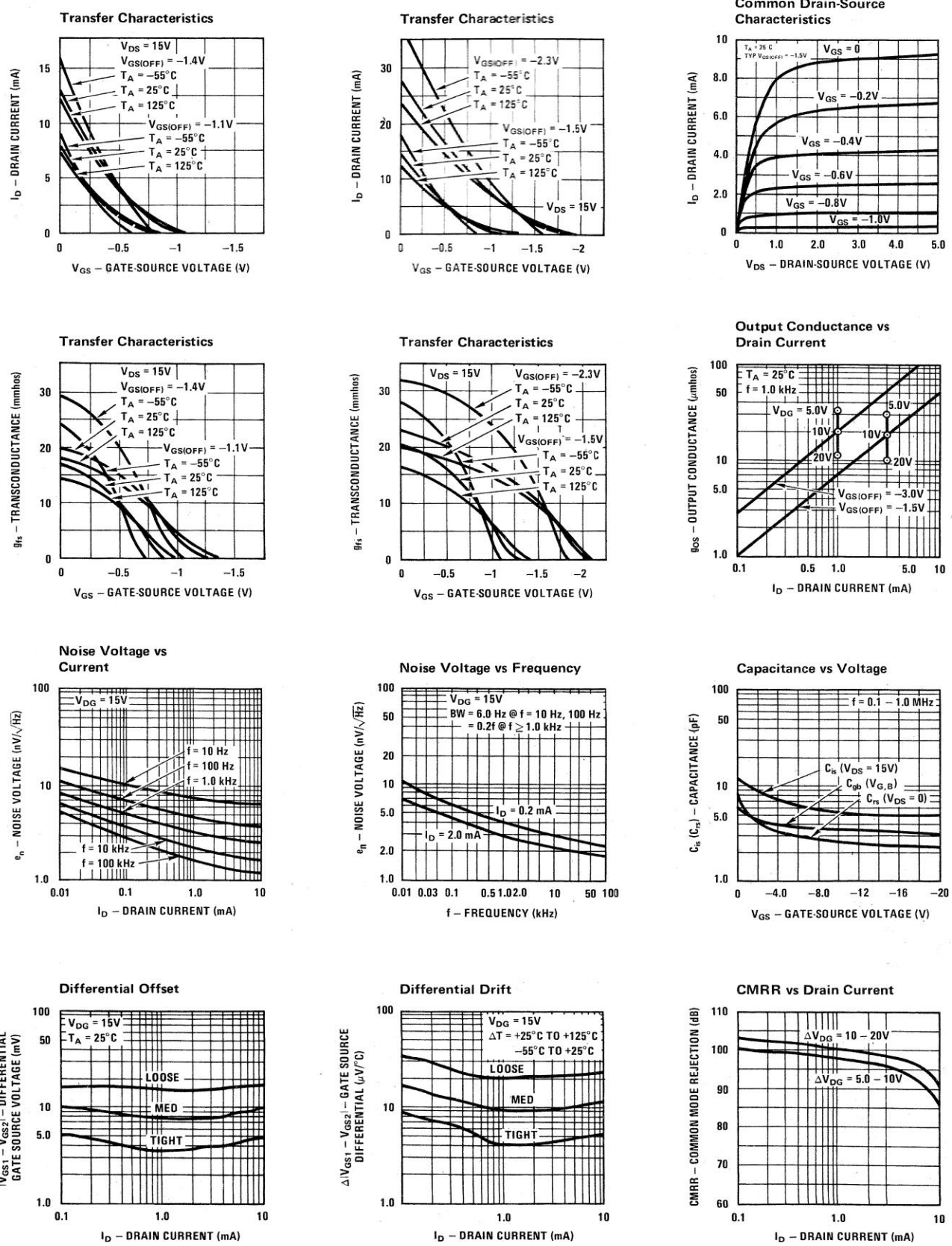

Process 98 N-Channel JFET

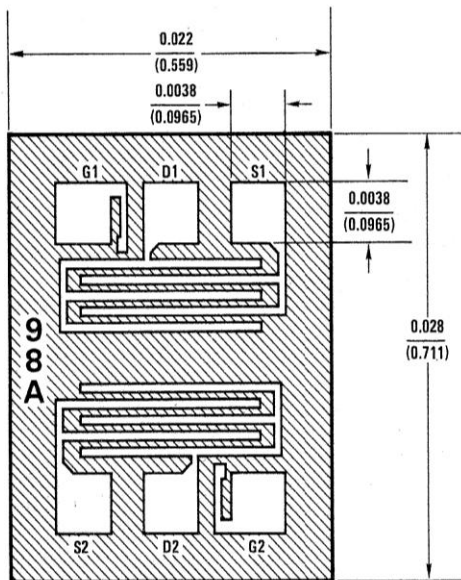

DESCRIPTION

Process 98 is a high gain, general purpose, monolithic dual JFET with a diode isolated substrate. It is intended for amplifier input stages requiring high gain, low noise and low offset drift over temperature. Strict processing controls result in low input bias currents and virtually immeasurable offset currents. Matching characteristics are essentially independent of operating current and voltage.

This process is available in the following device types.

*Denotes preferred parts.

2N5561	J401
2N5562	J402
2N5563	J403
U401	J404
U402	J405
U403	J406
U404	
U405	
U406	

References

[1] 1977 JFET DATABOOK, National Semiconductor

Editor: Richard Dunipace, June 2015.

DISCLAIMER

FAIRCHILD SEMICONDUCTOR RESERVES THE RIGHT TO MAKE CHANGES WITHOUT FURTHER NOTICE TO ANY PRODUCTS HEREIN TO IMPROVE RELIABILITY, FUNCTION, OR DESIGN. FAIRCHILD DOES NOT ASSUME ANY LIABILITY ARISING OUT OF THE APPLICATION OR USE OF ANY PRODUCT OR CIRCUIT DESCRIBED HEREIN; NEITHER DOES IT CONVEY ANY LICENSE UNDER ITS PATENT RIGHTS, NOR THE RIGHTS OF OTHERS.

LIFE SUPPORT POLICY

FAIRCHILD'S PRODUCTS ARE NOT AUTHORIZED FOR USE AS CRITICAL COMPONENTS IN LIFE SUPPORT DEVICES OR SYSTEMS WITHOUT THE EXPRESS WRITTEN APPROVAL OF THE PRESIDENT OF FAIRCHILD SEMICONDUCTOR CORPORATION.

As used herein:

1. Life support devices or systems are devices or systems which, (a) are intended for surgical implant into the body, or (b) support or sustain life, or (c) whose failure to perform when properly used in accordance with instructions for use provided in the labeling, can be reasonably expected to result in significant injury to the user.
2. A critical component is any component of a life support device or system whose failure to perform can be reasonably expected to cause the failure of the life support device or system, or to affect its safety or effectiveness.

ON Semiconductor and  are trademarks of Semiconductor Components Industries, LLC dba ON Semiconductor or its subsidiaries in the United States and/or other countries. ON Semiconductor owns the rights to a number of patents, trademarks, copyrights, trade secrets, and other intellectual property. A listing of ON Semiconductor's product/patent coverage may be accessed at www.onsemi.com/site/pdf/Patent-Marking.pdf. ON Semiconductor reserves the right to make changes without further notice to any products herein. ON Semiconductor makes no warranty, representation or guarantee regarding the suitability of its products for any particular purpose, nor does ON Semiconductor assume any liability arising out of the application or use of any product or circuit, and specifically disclaims any and all liability, including without limitation special, consequential or incidental damages. Buyer is responsible for its products and applications using ON Semiconductor products, including compliance with all laws, regulations and safety requirements or standards, regardless of any support or applications information provided by ON Semiconductor. "Typical" parameters which may be provided in ON Semiconductor data sheets and/or specifications can and do vary in different applications and actual performance may vary over time. All operating parameters, including "Typicals" must be validated for each customer application by customer's technical experts. ON Semiconductor does not convey any license under its patent rights nor the rights of others. ON Semiconductor products are not designed, intended, or authorized for use as a critical component in life support systems or any FDA Class 3 medical devices or medical devices with a same or similar classification in a foreign jurisdiction or any devices intended for implantation in the human body. Should Buyer purchase or use ON Semiconductor products for any such unintended or unauthorized application, Buyer shall indemnify and hold ON Semiconductor and its officers, employees, subsidiaries, affiliates, and distributors harmless against all claims, costs, damages, and expenses, and reasonable attorney fees arising out of, directly or indirectly, any claim of personal injury or death associated with such unintended or unauthorized use, even if such claim alleges that ON Semiconductor was negligent regarding the design or manufacture of the part. ON Semiconductor is an Equal Opportunity/Affirmative Action Employer. This literature is subject to all applicable copyright laws and is not for resale in any manner.

PUBLICATION ORDERING INFORMATION

LITERATURE FULFILLMENT:

Literature Distribution Center for ON Semiconductor
19521 E. 32nd Pkwy, Aurora, Colorado 80011 USA
Phone: 303-675-2175 or 800-344-3860 Toll Free USA/Canada
Fax: 303-675-2176 or 800-344-3867 Toll Free USA/Canada
Email: orderlit@onsemi.com

N. American Technical Support: 800-282-9855 Toll Free
USA/Canada
Europe, Middle East and Africa Technical Support:
Phone: 421 33 790 2910
Japan Customer Focus Center
Phone: 81-3-5817-1050

ON Semiconductor Website: www.onsemi.com
Order Literature: <http://www.onsemi.com/orderlit>
For additional information, please contact your local
Sales Representative