

434MHz LNA for RKE Using the 2SC5490A



ON Semiconductor®

<http://onsemi.com>

Application Note

Overview

This application note explains about ON Semiconductor's 2SC5490A which is used as a Low Noise Amplifier (LNA) for RKE (Remote Keyless Entry).

The 2SC5490A is a silicon bipolar transistor best suited for high-frequency applications which is assembled in the 3-pin surface mount package.

For information about the performance, please refer to the datasheet of this product.

Since the evaluation board is adjusted to achieve optimal performance in RKE (434 MHz), the product can provide 14.6dB gain and 1.45dB noise figure.

A standard material FR4 is used for the printed circuit board (PCB).

Please note that the losses of the PCB and the SMA connector are not excluded from the noise figure.

434MHz LNA for RKE Using the 2SC5490A

■Summary of Data

Ta = 25 °C, Input Power = -40 dBm

Parameter	Symbol	Condition	Result	Unit
DC Voltage	Vcc		3.0	V
DC Current	Icc		1.96	mA
Power Gain	Gp	f = 434 MHz	14.6	dB
Noise Figure	NF	f = 434 MHz	1.45	dB
Input Return Loss	RLin	f = 434 MHz	5.6	dB
Output Return Loss	RLout	f = 434 MHz	12.3	dB
Isolation	ISL	f = 434 MHz	19.5	dB
Gain 1dB Compression Input Power	Pin1dB	f = 434 MHz	-20	dBm
Input 3rd Order Intercept Point	IIP3	f1 = 433 MHz f2 = 434 MHz Pin = -35 dBm	-10	dBm

434MHz LNA for RKE Using the 2SC5490A

■Circuit Design

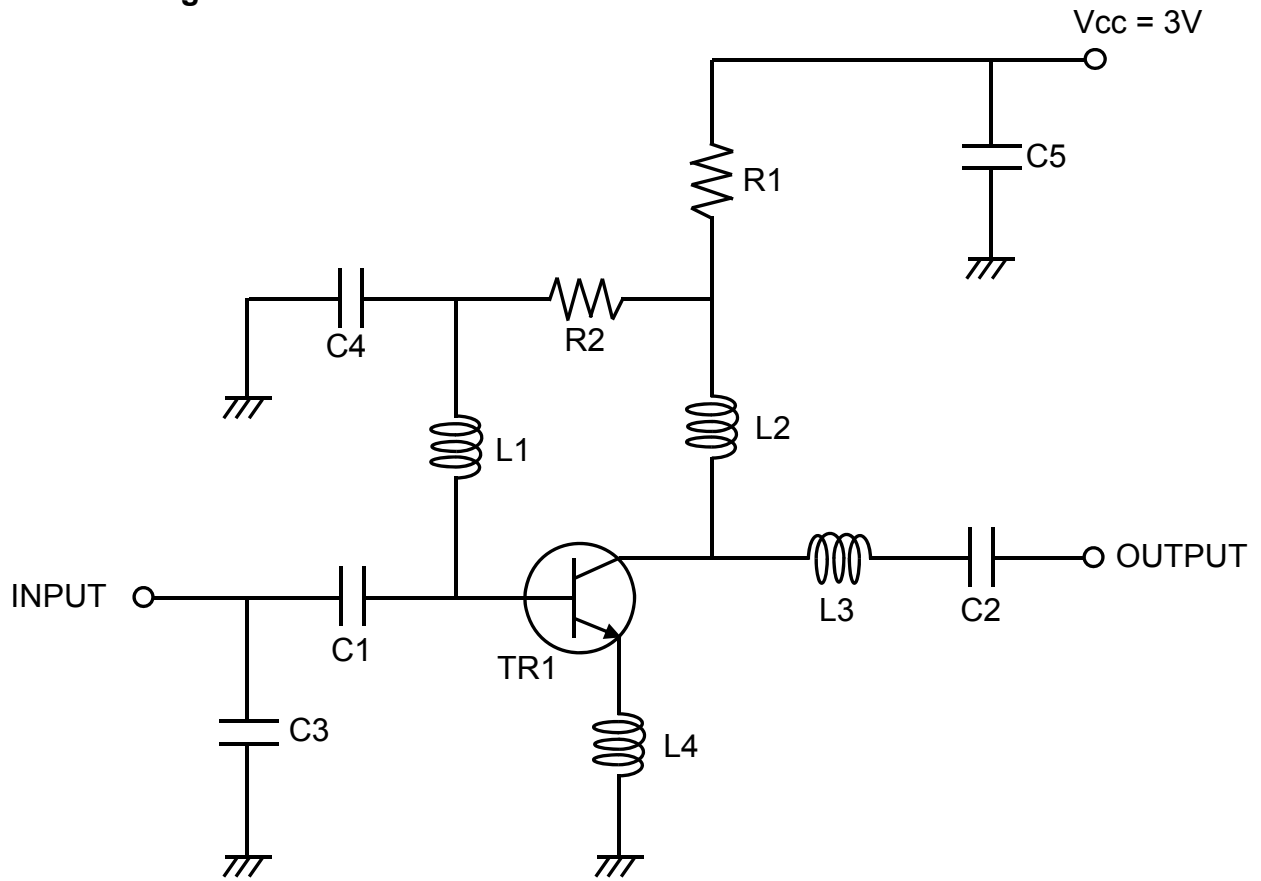

■Evaluation Board

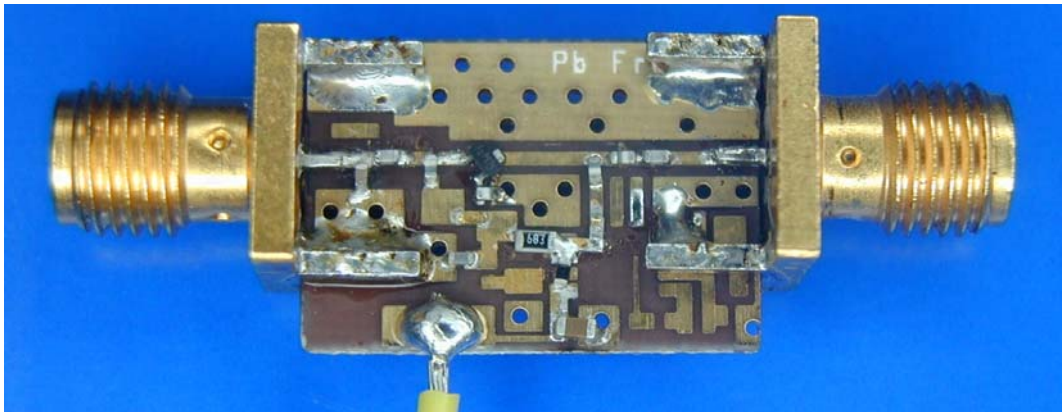

434MHz LNA for RKE Using the 2SC5490A

■Bill of Materials

Item	Symbol	Value	Manufacturer	Size
Bip-Tr	TR1	2SC5490A	ON Semiconductor	SC81
Capacitor	C1	10 pF	Murata GRM155	1005
	C2	6 pF	Murata GRM155	1005
	C3	4 pF	Murata GRM155	1005
	C4	150 pF	Murata GRM155	1005
	C5	0.1 uF	Various	1608
Resistor	R1	680 Ω	Various	1005
	R2	68 k Ω	Various	1608
Inductor	L1	22 nH	TDK MLG1005S	1005
	L2	10 nH	TDK MLG1005S	1005
	L3	39 nH	TDK MLG1005S	1005
	L4	2.2 nH	TDK MLG1005S	1005
Material	-	FR4	-	19 x 12 mm

434MHz LNA for RKE Using the 2SC5490A

■ Power Gain

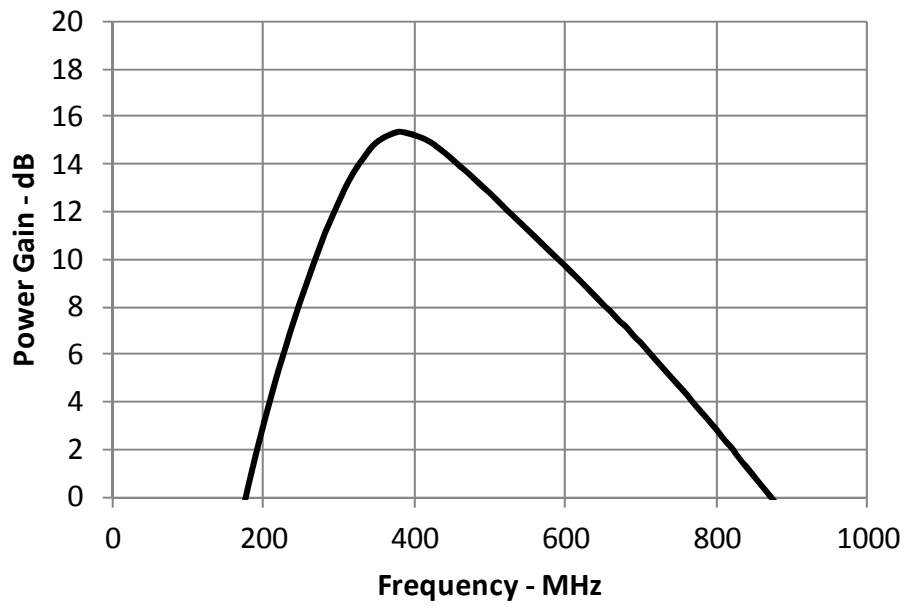

■ Isolation

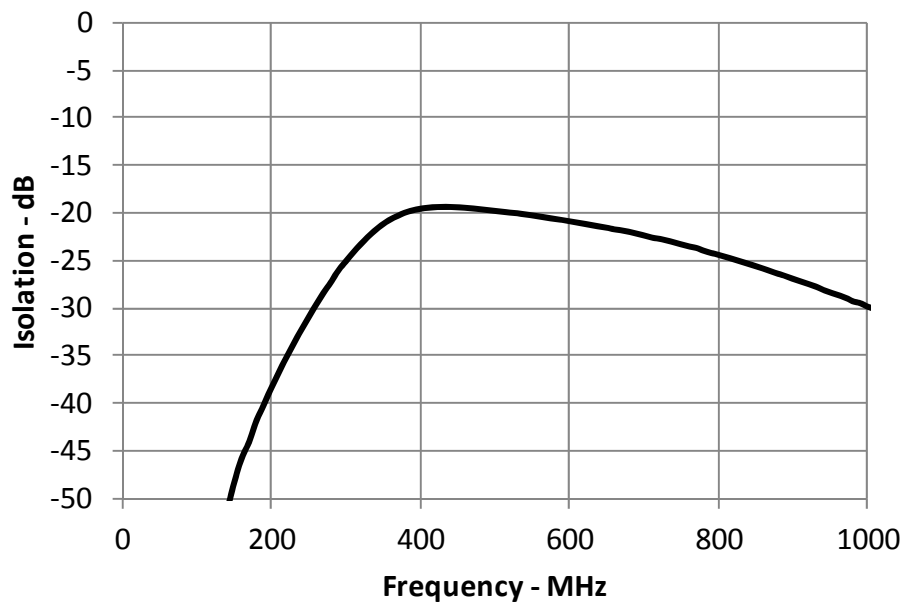

434MHz LNA for RKE Using the 2SC5490A

■ Input Return Loss

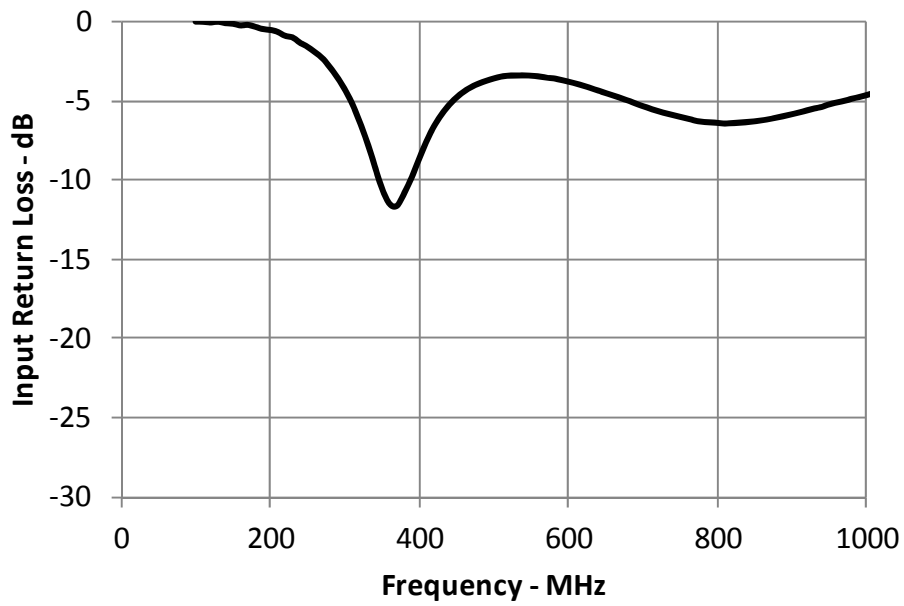

■ Output Return Loss

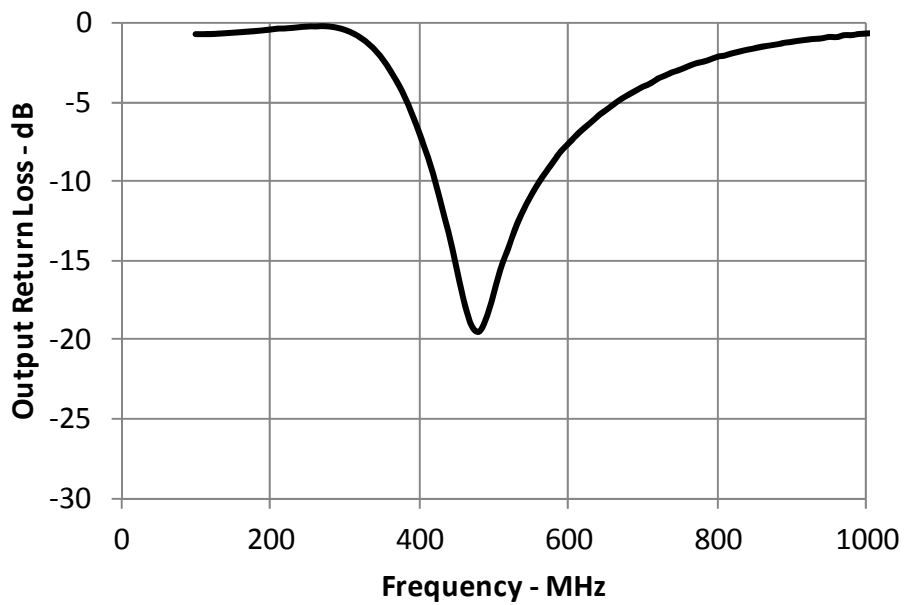

434MHz LNA for RKE Using the 2SC5490A

■ Noise Figure

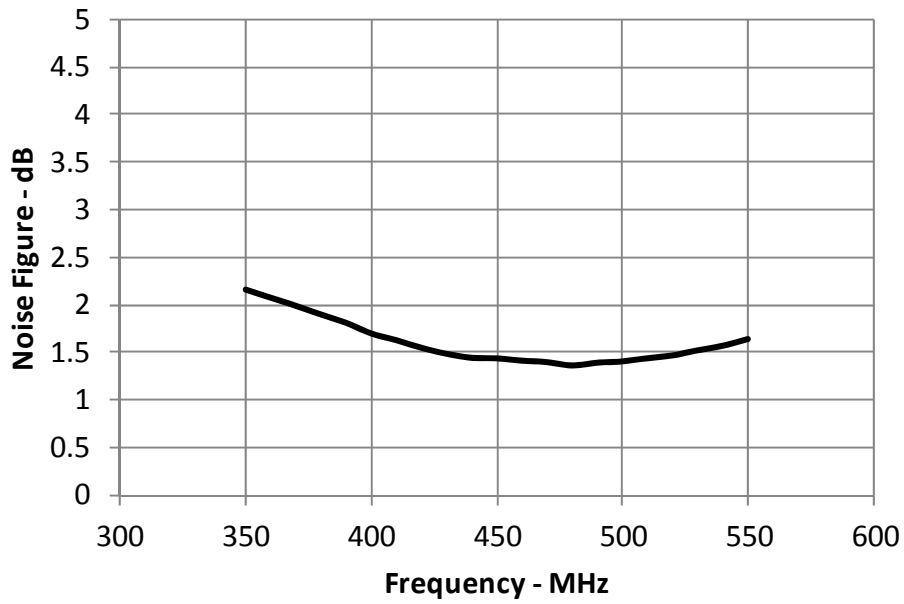

■ S11, S21, S12, S22 Wide Span

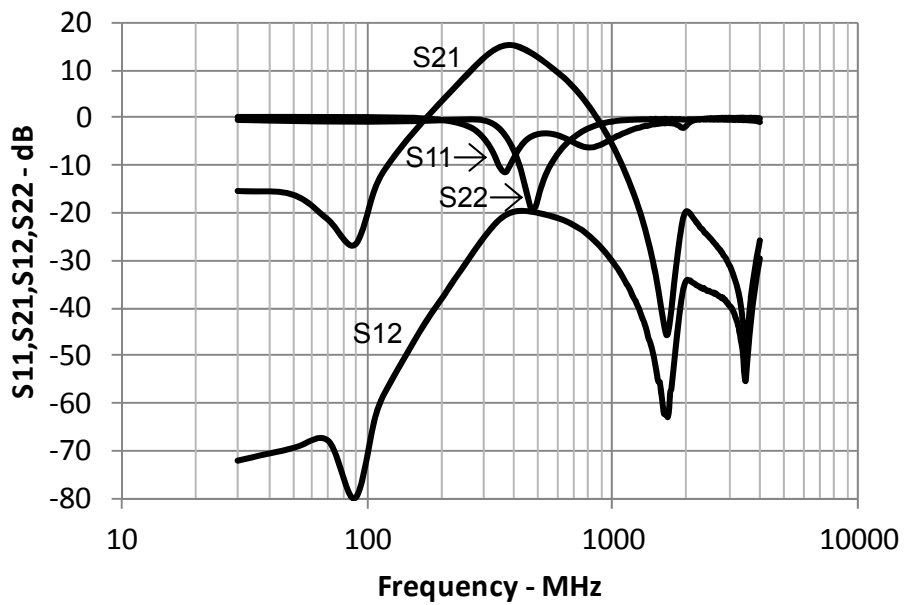

434MHz LNA for RKE Using the 2SC5490A

■Smith Chart Input Return Loss

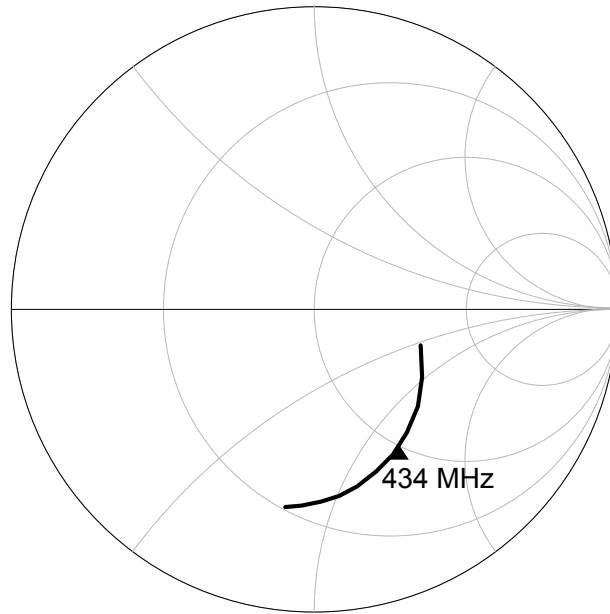

400 MHz to 500 MHz

■Smith Chart Output Return Loss

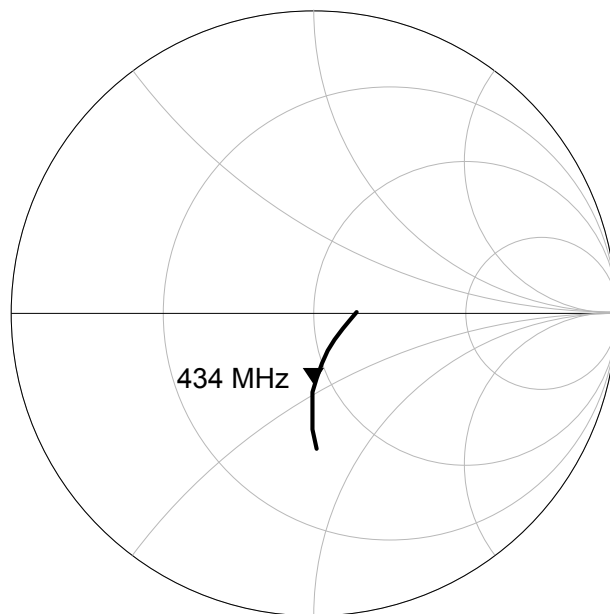

400 MHz to 500 MHz

434MHz LNA for RKE Using the 2SC5490A

■ Gain 1dB Compression Point

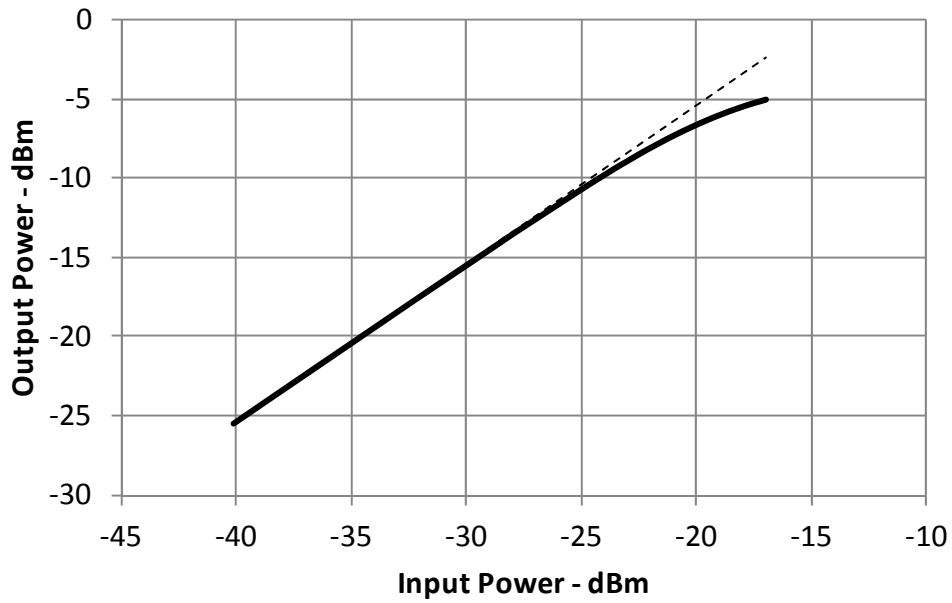

■ Input 3rd Order Intercept Point

f1 = 433 MHz, f2 = 434 MHz, Pin = -35 dBm

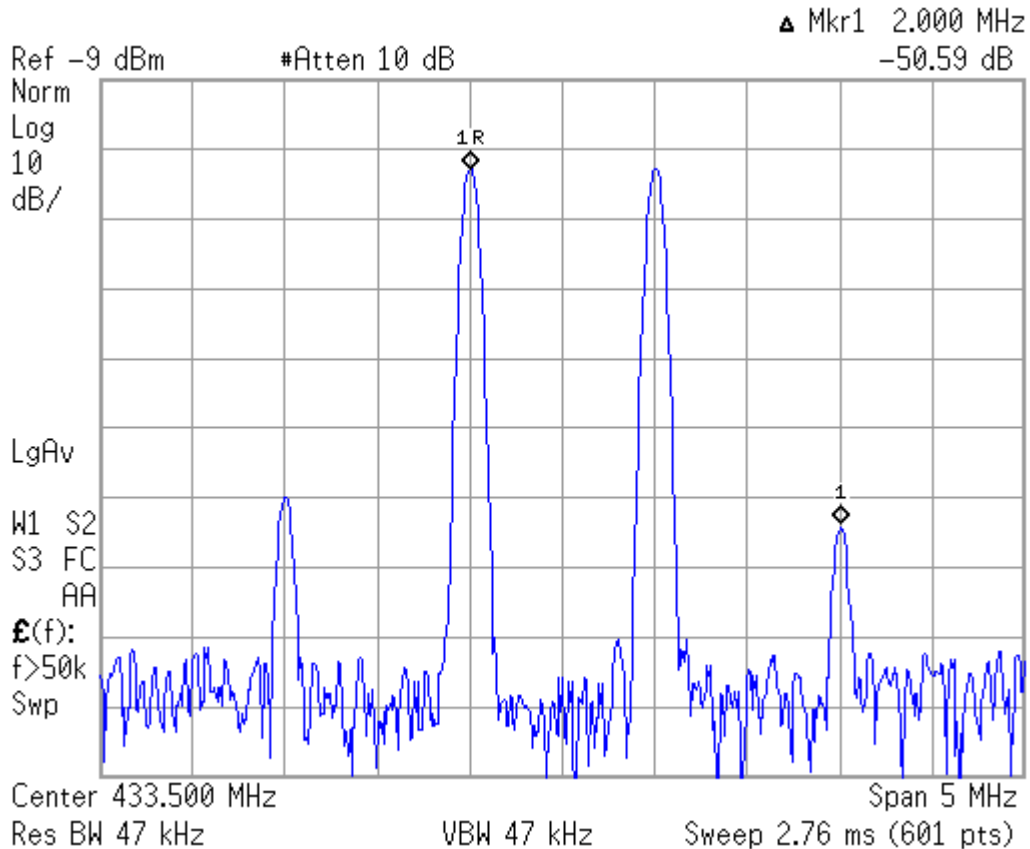

434MHz LNA for RKE Using the 2SC5490A

ON Semiconductor and the ON logo are registered trademarks of Semiconductor Components Industries, LLC (SCILLC). SCILLC owns the rights to a number of patents, trademarks, copyrights, trade secrets, and other intellectual property. A listing of SCILLC's product/patent coverage may be accessed at www.onsemi.com/site/pdf/Patent-Marking.pdf. SCILLC reserves the right to make changes without further notice to any products herein. SCILLC makes no warranty, representation or guarantee regarding the suitability of its products for any particular purpose, nor does SCILLC assume any liability arising out of the application or use of any product or circuit, and specifically disclaims any and all liability, including without limitation special, consequential or incidental damages. "Typical" parameters which may be provided in SCILLC data sheets and/or specifications can and do vary in different applications and actual performance may vary over time. All operating parameters, including "Typicals" must be validated for each customer application by customer's technical experts. SCILLC does not convey any license under its patent rights nor the rights of others. SCILLC products are not designed, intended, or authorized for use as components in systems intended for surgical implant into the body, or other applications intended to support or sustain life, or for any other application in which the failure of the SCILLC product could create a situation where personal injury or death may occur. Should Buyer purchase or use SCILLC products for any such unintended or unauthorized application, Buyer shall indemnify and hold SCILLC and its officers, employees, subsidiaries, affiliates, and distributors harmless against all claims, costs, damages, and expenses, and reasonable attorney fees arising out of, directly or indirectly, any claim of personal injury or death associated with such unintended or unauthorized use, even if such claim alleges that SCILLC was negligent regarding the design or manufacture of the part. SCILLC is an Equal Opportunity/Affirmative Action Employer. This literature is subject to all applicable copyright laws and is not for resale in any manner.