

## Performance of Echo Cancellor of LC823450



ON Semiconductor®

[www.onsemi.com](http://www.onsemi.com)

### APPLICATION NOTE

#### INTRODUCTION

This application note describes the performance of Echo Canceller of LC823450 Series (called LC823450 hereafter).

The customer can improve the sound quality of hands free communication by using this canceller. Its function can be used for various products such as Wireless headset, Earbuds or other voice communication products.

Intended audience is customers who are building audio application using LC823450.

#### OVERVIEW OF ECHO CANCELLER

Figure 1 shows a block diagram of HFP signal processing of LC823450. The sound quality of hands free communication depends on many parts. However, the performance of echo cancelling depends on AEC (Acoustic echo canceller) and NC (Noise canceller). Those parts are surrounded in a red dot line of Figure 1.

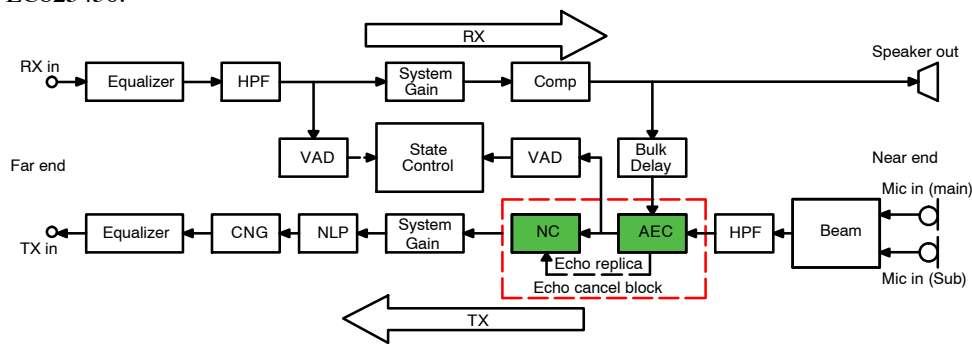

Figure 1. Block Diagram of HFP Program of LC823450

NC cancels not only noise signal but also echo signal which was estimated by AEC in echo cancel process. LC823450 has two types of echo cancelling mode as follows.

#### 1. Time domain mode (Figure 2)

In this mode, AEC cancels echo signal in time domain. After that, NC cancels estimated echo signal by AEC in frequency domain secondarily to improve the performance as secondarily echo cancellation

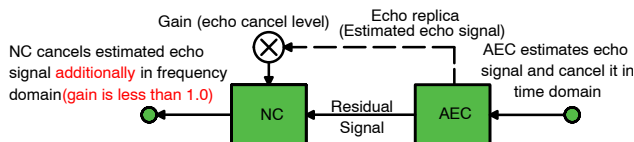

Figure 2. Time Domain Mode

#### 2. Frequency domain mode (Figure 3)

In this mode, echo cancel process is conducted only by NC in frequency domain. AEC only estimates echo signal

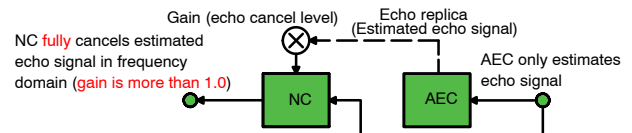
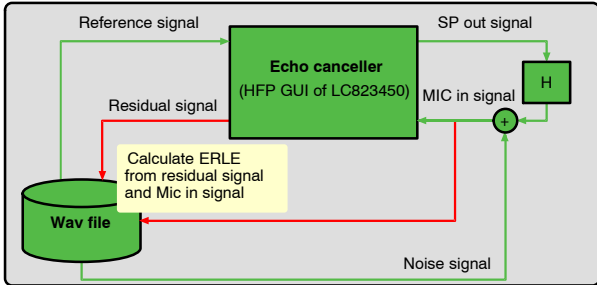

Figure 3. Frequency Domain Mode

**EVALUATION ENVIRONMENT AND CONDITION**

We used HFP GUI of LC823450 which is carried out on Windows PC for this evaluation. Results of this GUI are bit exact with the function implemented in LC823450. We used only AEC and NC in GUI and did not use other blocks. NC was used only for echo canceling, not for noise cancelling.

Figure 4 shows overview of this simulation.



**Figure 4. Overview of PC Simulation**

We used wav files as reference input signal and mic in signal (echo signal) for input of HFP GUI. We used white noise and pink noise for reference signal. Mic in signal is created from SP out signal by adding echo pass characteristics “H” and ambient noise. SP out signal is a speaker output signal. Residual signal is a result of echo cancelling.

We checked the performance of echo canceller from the difference between Mic in signal and Residual signal.

**Echo Canceller Setting**

We evaluated echo cancelling function under the conditions as shown in Table 1.

**Table 1. ECHO CANCELLER SETTINGS**

Item	Condition
Input signal	16 kHz, signed 16bit linear PCM
Acoustic echo canceller	Tap size is 128 sample.
Noise canceller	FFT size is 256 sample. Frame shift is 128 sample
Echo cancel level	Time domain mode Echo cancel level 0.0 Echo cancel level 0.05 Echo cancel level 0.2 Frequency domain mode Echo cancel level 1.0 Echo cancel level 1.05 Echo cancel level 1.2

**Reference input signal**

We use white noise and pink noise as reference input signal. White noise is used to evaluate ERLE. On the other hand, we used pink noise to evaluate convergence time. Because our echo canceller is tuned to human voice, convergence time of white noise is not appropriate.

**Echo Pass**

We created echo pass characteristics as follows;

1. Add zero data to the start point of SP output signal wav file as echo pass delay
2. Attenuate the signal as echo pass return loss
3. Clip the signal to create distortion with target THD

Clip level was decided from 4th harmonics THD of 1 kHz Sine signal. Table 2 shows clip levels used in this experiment. Echo signal is clipped with the value of shown percentage of peak signal level.

**Table 2. CLIP LEVEL FOR TARGET THD**

THD (%)	Clip level (%)	THD (%)	Clip level (%)
0.2	99.5	1.8	95.9
0.4	99.1	2.0	95.4
0.6	98.6	2.2	95.0
0.8	98.2	2.4	94.5
1.0	97.7	2.6	94.1
1.2	97.2	2.8	93.6
1.4	96.8	3.0	93.2
1.6	96.3		

**Noise Signal**

We added noise signal as an ambient noise and double talk.

For ambient noise, we added white noise so that the SNR of echo signal become target SNR as shown in Figure 5.

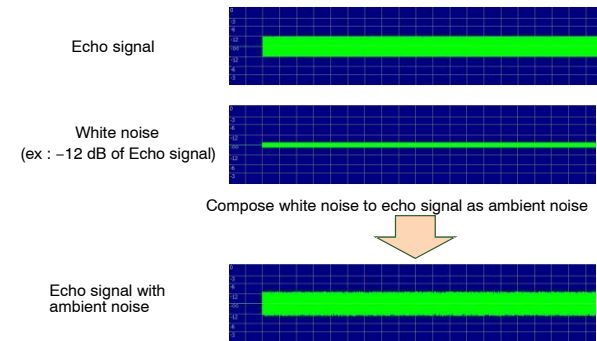

**Figure 5. Echo Signal with Ambient Noise**

For double talk, we added white noise as double talk. Figure 6 shows an example of mic in signal with double talk.

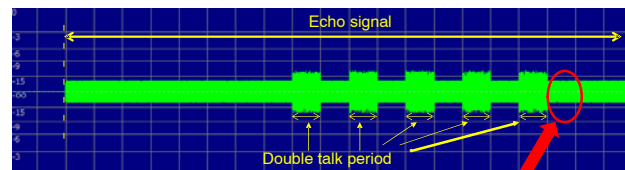

Calculate ERLE of this area for a performance of double talk

**Figure 6. Waveform which White Noise Added to as Double Talk**

EVALUATION RESULTS

THD vs ERLE (Echo Return Loss Enhancement)

[Reference signal]

White noise with level of -6 dBFS.

[Echo signal]

Delay is 20 sample. Echo return loss is -6 dB.

THD is from 0.0% to 3.0% with 0.2% step.

If the percentage of THD is increased, there is a tendency that ERLE is decreased by the influence of THD. The result of frequency domain mode is better than the one of time domain mode.

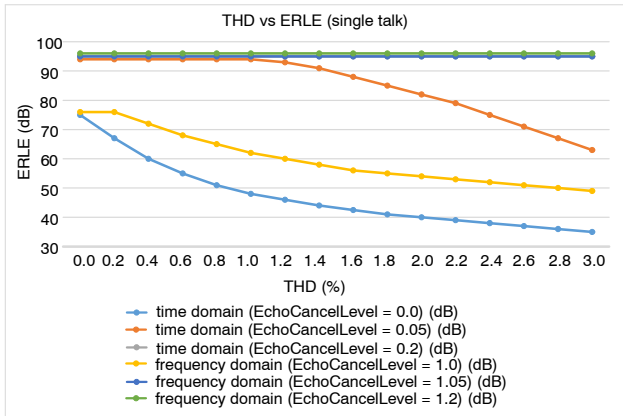

Figure 7. THD vs ERLE (Single Talk)

THD vs ERLE with Double Talk

When double talk occurs, the degradation of ERLE with high THD is smaller than that with low THD. If you use NC for secondarily echo cancellation at the same time in the time domain mode, the degradation of ERLE is improved. It is clear from the comparison of results between Echo cancel level = 0.0 and Echo cancel level = 0.05/0.2.

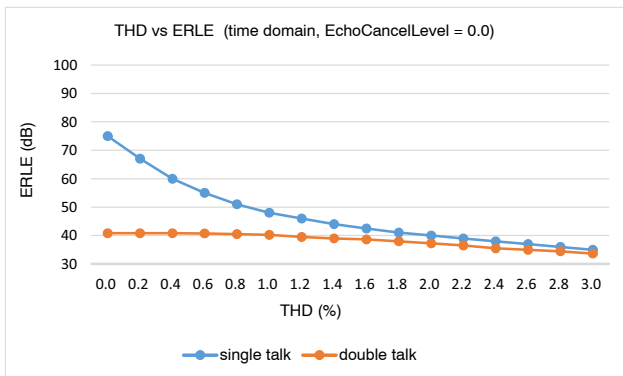

Figure 8. THD vs ERLE (Time Domain, Echo Cancel Level = 0.0)

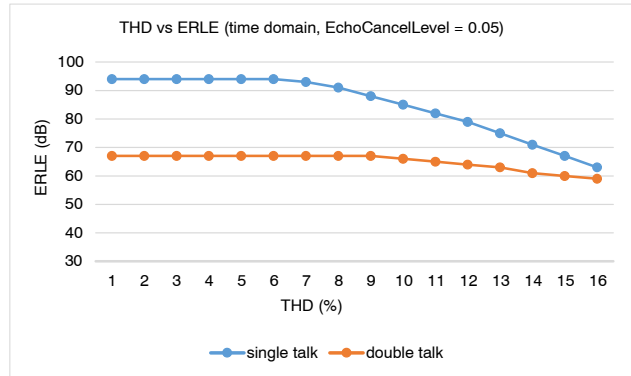

Figure 9. THD vs ERLE (Time Domain, Echo Cancel Level = 0.05)

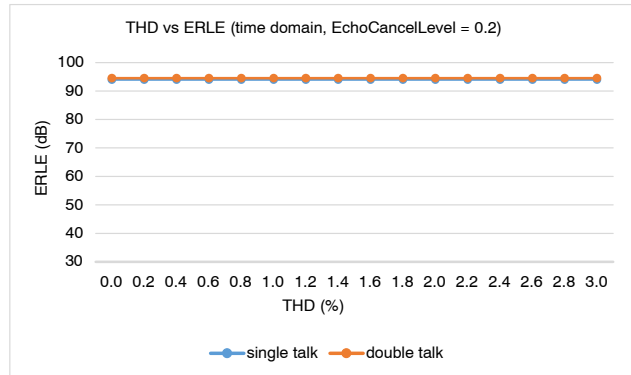

Figure 10. THD vs ERLE (Time Domain, Echo Cancel Level = 0.2)

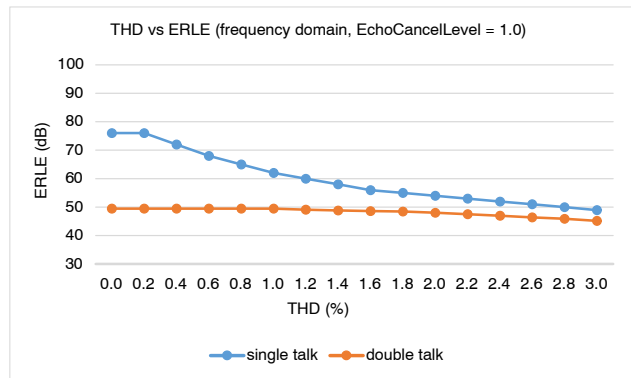
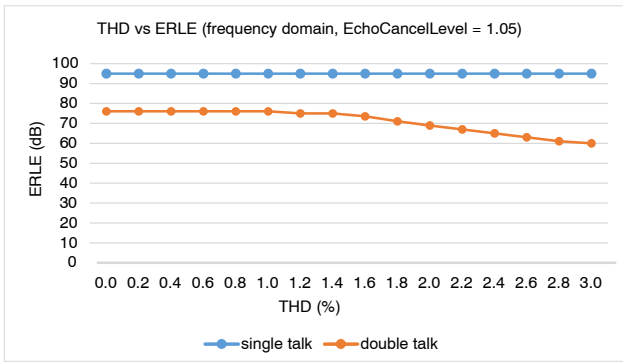
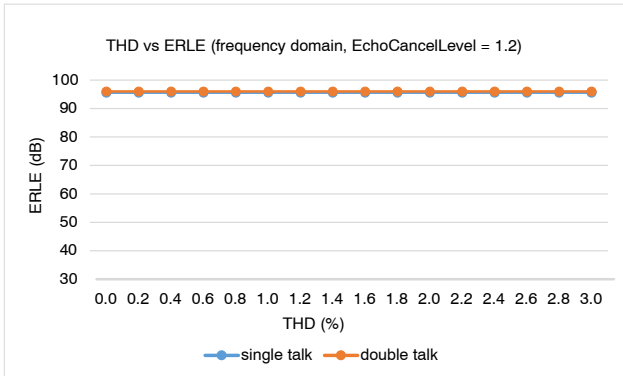

Figure 11. THD vs ERLE (Frequency Domain, Echo Cancel Level = 1.0)



**Figure 12. THD vs ERLE  
(Frequency Domain, Echo Cancel Level = 1.05)**



**Figure 13. THD vs ERLE  
(Frequency Domain, Echo Cancel Level = 1.2)**

**ERL vs ERLE**

[Reference signal]

White noise with level of -6 dBFS.

[Echo signal]

Delay is 20 sample. Echo return loss is from 0 dB to 39 dB with 3 dB step. THD is 0.4%.

Total echo return loss is ERL plus ERLE. Therefore, If ERL is increased, there is a tendency that ERLE is decreased. The result of frequency domain mode is better than the one of time domain mode.

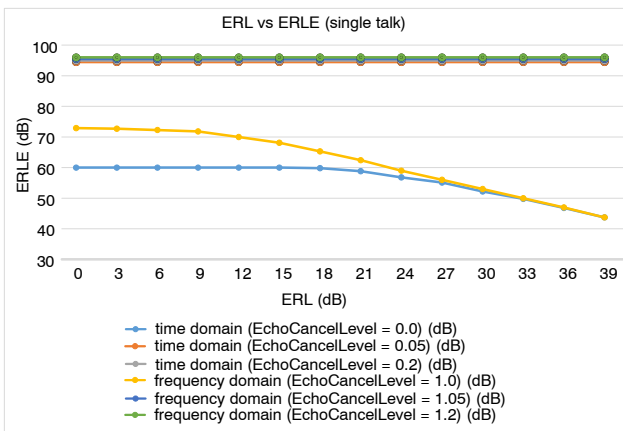

**Figure 14. ERL vs ERLE (Single Talk)**

**ERL vs ERLE with Double Talk**

When double talk occurs, ERLE is degraded about 20 dB without noise canceller as the secondary cancellation in the time domain mode. To avoid this degradation, you can use NC for secondary echo cancellation. In this case, the degradation becomes small as shown by the comparison of results between Echo cancel level = 0.0 and Echo cancel level = 0.05/0.2.

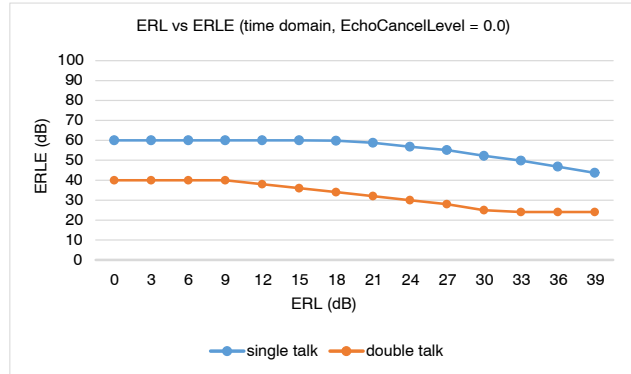

**Figure 15. ERL vs ERLE  
(Time Domain, Echo Cancel Level = 0.0)**

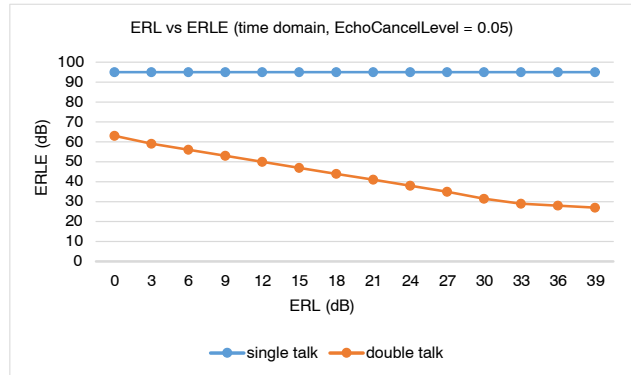

**Figure 16. ERL vs ERLE  
(Time Domain, Echo Cancel Level = 0.05)**

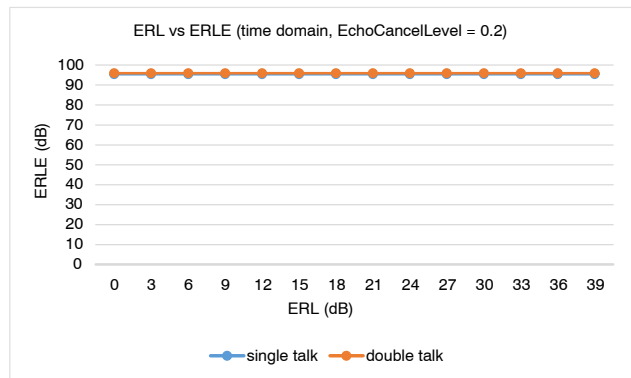

**Figure 17. ERL vs ERLE  
(Time Domain, Echo Cancel Level = 0.2)**

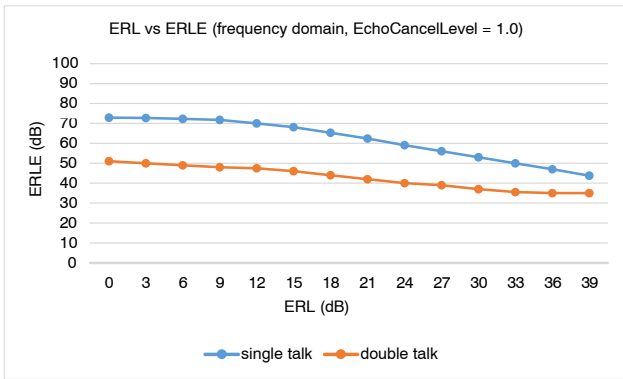

**Figure 18. ERL vs ERLE  
(Frequency Domain, Echo Cancel Level = 1.0)**

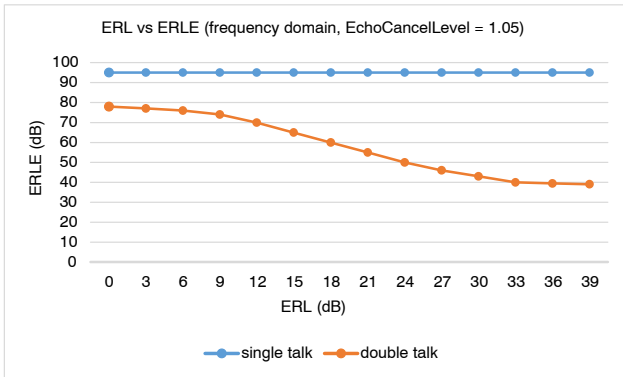

**Figure 19. ERL vs ERLE  
(Frequency Domain, Echo Cancel Level = 1.05)**

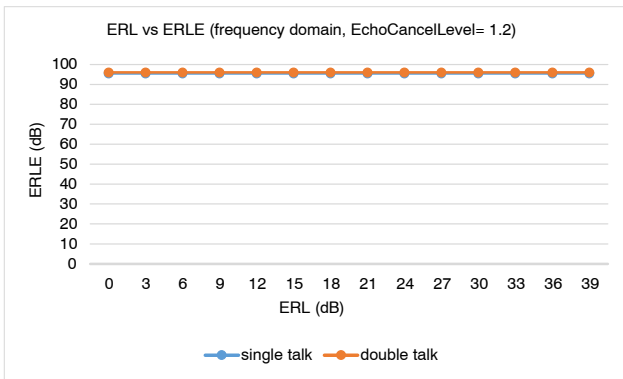

**Figure 20. ERL vs ERLE  
(Frequency Domain, Echo Cancel Level = 1.2)**

**Ambient Noise vs ERLE**

[Reference signal]

White noise with level of  $-6$  dBFS.

[Echo signal]

Delay is 20 sample. Echo return loss is  $-6$  dB. THD is 0.4%.

Ambient noise is added so that SNR becomes from  $-12$  dB to  $-39$  dB.

If ambient noise is added to echo-signal, echo canceller cannot reduce ambient noise. Therefore, residual signal includes ambient noise and ERLE is limited by them.

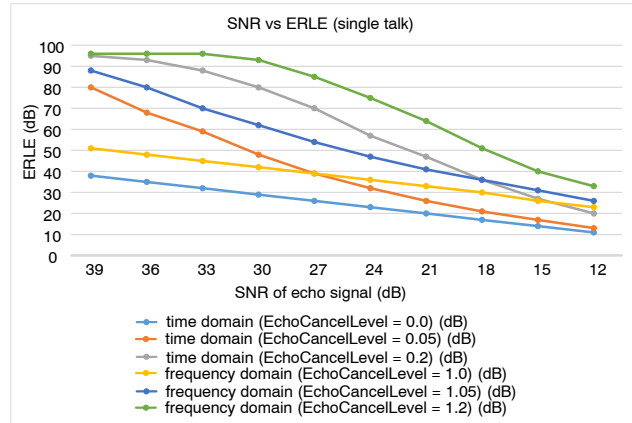

**Figure 21. Ambient Noise vs ERLE  
(Single Talk)**

**Ambient Noise vs ERLE with Double Talk**

When double talk occurs, ERLE is slightly degraded without noise canceller as the secondary cancellation in the time domain mode. If you use noise canceller for secondaryly echo cancellation, you can improve the performance of echo cancelling in double talk period. It is clear from the comparison of results between Echo cancel level = 0.0 and Echo cancel level = 0.05/0.2.

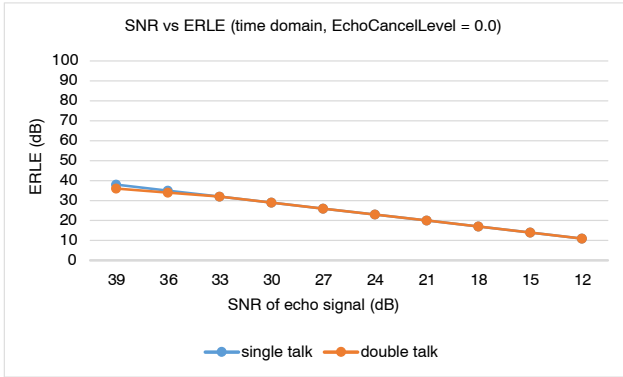

**Figure 22. Ambient Noise vs ERLE (Time Domain, Echo Cancel Level = 0.0)**

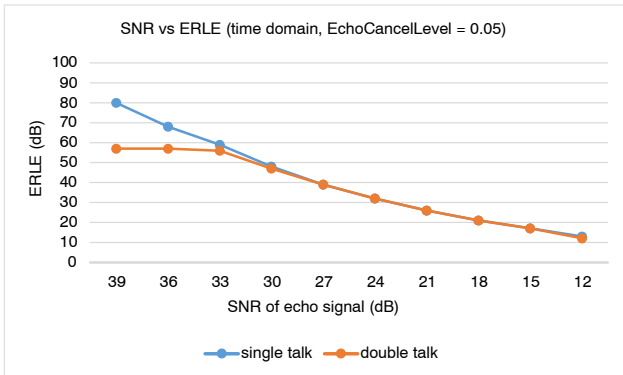

**Figure 23. Ambient Noise vs ERLE (Time Domain, Echo Cancel Level = 0.05)**

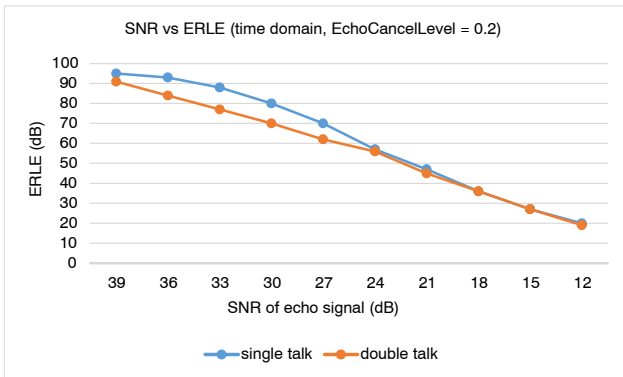

**Figure 24. Ambient Noise vs ERLE (Time Domain, Echo Cancel Level = 0.2)**

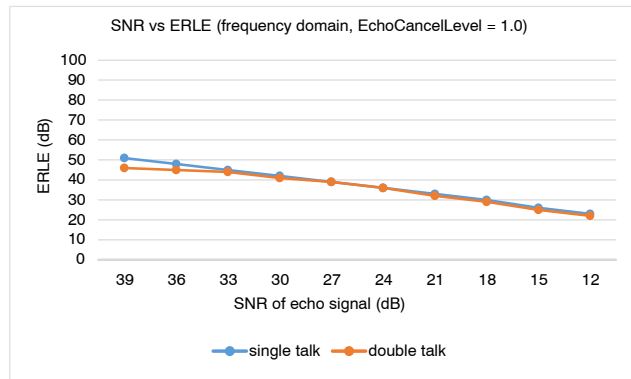

**Figure 25. Ambient Noise vs ERLE (Frequency Domain, Echo Cancel Level = 1.0)**

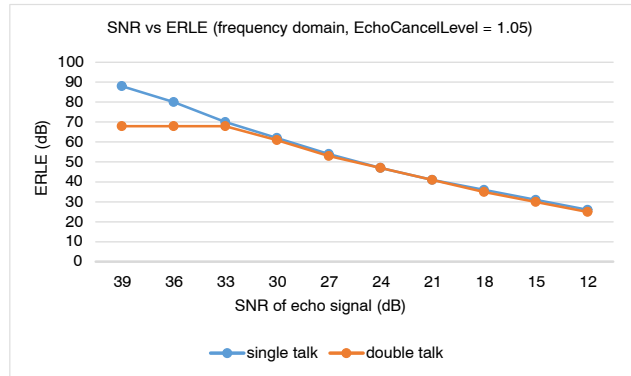

**Figure 26. Ambient Noise vs ERLE (Frequency Domain, Echo Cancel Level = 1.05)**

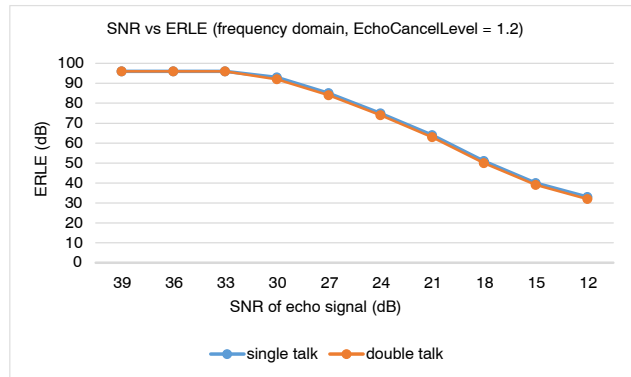

**Figure 27. Ambient Noise vs ERLE (Frequency Domain, Echo Cancel Level = 1.2)**

**Convergence time**

[Reference signal]

White noise with level of -6 dBFS

Pink noise with level of -6 dBFS

[Echo signal]

Delay is 20 sample. Echo return loss is from -6 to -12 dB with -3 dB step. THD is 0.0%

Table 3 and 4 shows a convergence time. Our echo canceller is tuned to human voice. Therefore, convergence time of pink noise is shorter than that of white noise.

**Table 4. CONVERGENCE TIME WITH PINK NOISE**

Test Signal is Pink Noise	ERL		
	0 dB	-6 dB	-12 dB
Convergence time to obtain 24 dB ERLE	300 ms	280 ms	260 ms
Convergence time to obtain 54 dB ERLE	325 ms	305 ms	285 ms

**Table 3. CONVERGENCE TIME WITH WHITE NOISE**

Test Signal is White Noise	ERL		
	0 dB	-6 dB	-12 dB
Convergence time to obtain 24 dB ERLE	700 ms	580 ms	400 ms
Convergence time to obtain 54 dB ERLE	1300 ms	1300 ms	1300 ms

ON Semiconductor and  are trademarks of Semiconductor Components Industries, LLC dba ON Semiconductor or its subsidiaries in the United States and/or other countries. ON Semiconductor owns the rights to a number of patents, trademarks, copyrights, trade secrets, and other intellectual property. A listing of ON Semiconductor's product/patent coverage may be accessed at [www.onsemi.com/site/pdf/Patent-Marking.pdf](http://www.onsemi.com/site/pdf/Patent-Marking.pdf). ON Semiconductor reserves the right to make changes without further notice to any products herein. ON Semiconductor makes no warranty, representation or guarantee regarding the suitability of its products for any particular purpose, nor does ON Semiconductor assume any liability arising out of the application or use of any product or circuit, and specifically disclaims any and all liability, including without limitation special, consequential or incidental damages. Buyer is responsible for its products and applications using ON Semiconductor products, including compliance with all laws, regulations and safety requirements or standards, regardless of any support or applications information provided by ON Semiconductor. "Typical" parameters which may be provided in ON Semiconductor data sheets and/or specifications can and do vary in different applications and actual performance may vary over time. All operating parameters, including "Typicals" must be validated for each customer application by customer's technical experts. ON Semiconductor does not convey any license under its patent rights nor the rights of others. ON Semiconductor products are not designed, intended, or authorized for use as a critical component in life support systems or any FDA Class 3 medical devices or medical devices with a same or similar classification in a foreign jurisdiction or any devices intended for implantation in the human body. Should Buyer purchase or use ON Semiconductor products for any such unintended or unauthorized application, Buyer shall indemnify and hold ON Semiconductor and its officers, employees, subsidiaries, affiliates, and distributors harmless against all claims, costs, damages, and expenses, and reasonable attorney fees arising out of, directly or indirectly, any claim of personal injury or death associated with such unintended or unauthorized use, even if such claim alleges that ON Semiconductor was negligent regarding the design or manufacture of the part. ON Semiconductor is an Equal Opportunity/Affirmative Action Employer. This literature is subject to all applicable copyright laws and is not for resale in any manner.

**PUBLICATION ORDERING INFORMATION**

**LITERATURE FULFILLMENT:**

Literature Distribution Center for ON Semiconductor  
 19521 E. 32nd Pkwy, Aurora, Colorado 80011 USA  
**Phone:** 303-675-2175 or 800-344-3860 Toll Free USA/Canada  
**Fax:** 303-675-2176 or 800-344-3867 Toll Free USA/Canada  
**Email:** [orderlit@onsemi.com](mailto:orderlit@onsemi.com)

**N. American Technical Support:** 800-282-9855 Toll Free USA/Canada  
**Europe, Middle East and Africa Technical Support:** Phone: 421 33 790 2910

**ON Semiconductor Website:** [www.onsemi.com](http://www.onsemi.com)  
**Order Literature:** <http://www.onsemi.com/orderlit>

For additional information, please contact your local Sales Representative