

# ON Semiconductor

## Is Now

# onsemi™

To learn more about onsemi™, please visit our website at  
[www.onsemi.com](http://www.onsemi.com)

---

**onsemi** and **onsemi** and other names, marks, and brands are registered and/or common law trademarks of Semiconductor Components Industries, LLC dba "**onsemi**" or its affiliates and/or subsidiaries in the United States and/or other countries. **onsemi** owns the rights to a number of patents, trademarks, copyrights, trade secrets, and other intellectual property. A listing of **onsemi** product/patent coverage may be accessed at [www.onsemi.com/site/pdf/Patent-Marking.pdf](http://www.onsemi.com/site/pdf/Patent-Marking.pdf). **onsemi** reserves the right to make changes at any time to any products or information herein, without notice. The information herein is provided "as-is" and **onsemi** makes no warranty, representation or guarantee regarding the accuracy of the information, product features, availability, functionality, or suitability of its products for any particular purpose, nor does **onsemi** assume any liability arising out of the application or use of any product or circuit, and specifically disclaims any and all liability, including without limitation special, consequential or incidental damages. Buyer is responsible for its products and applications using **onsemi** products, including compliance with all laws, regulations and safety requirements or standards, regardless of any support or applications information provided by **onsemi**. "Typical" parameters which may be provided in **onsemi** data sheets and/or specifications can and do vary in different applications and actual performance may vary over time. All operating parameters, including "Typicals" must be validated for each customer application by customer's technical experts. **onsemi** does not convey any license under any of its intellectual property rights nor the rights of others. **onsemi** products are not designed, intended, or authorized for use as a critical component in life support systems or any FDA Class 3 medical devices or medical devices with a same or similar classification in a foreign jurisdiction or any devices intended for implantation in the human body. Should Buyer purchase or use **onsemi** products for any such unintended or unauthorized application, Buyer shall indemnify and hold **onsemi** and its officers, employees, subsidiaries, affiliates, and distributors harmless against all claims, costs, damages, and expenses, and reasonable attorney fees arising out of, directly or indirectly, any claim of personal injury or death associated with such unintended or unauthorized use, even if such claim alleges that **onsemi** was negligent regarding the design or manufacture of the part. **onsemi** is an Equal Opportunity/Affirmative Action Employer. This literature is subject to all applicable copyright laws and is not for resale in any manner. Other names and brands may be claimed as the property of others.

## Antenna Coil Prototype Design for Dual Interface RFID EEPROM Tag N24RFxx

The N24RFxxE is a RFID/NFC tag with xx indicating the equivalent memory size of 04/16/64 Kb EEPROM device offering both contactless and contact interface with Energy Harvesting capability.

This document describes and demonstrates different types of antenna design for a NFC application with RF contactless interface operating at 13.56 MHz.

The picture below shows the pins AN<sub>1</sub> and AN<sub>2</sub> of the N24RFxxE input pins used to connect the device to an external antenna in terms of inductor coil. The coil is used to power and access the device through the ISO 15693 RF protocols. The internal tuning capacitor or the input capacitance of the device varies from 26 pF to 30 pF by applying AC voltage from 1 V<sub>pp</sub> to 2 V<sub>pp</sub> verified with a LCR meter. The inductivity of L<sub>Ant</sub> need to be selected in conjunction with input capacity of the device to get the resonance frequency at 13.56 MHz according to the eq.1.

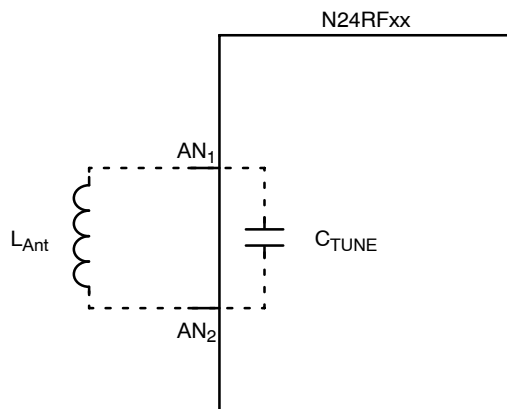

Figure 1. Antenna

$$f_{res} = \frac{1}{2\pi\sqrt{L_{ANT} C_{TUNE}}} \quad (\text{eq. 1})$$



ON Semiconductor®

[www.onsemi.com](http://www.onsemi.com)

### APPLICATION NOTE

The picture below shows the impedance of a RLC resonance circuit. At the resonance frequency, the reactance compensate to each other, below the resonance frequency capacitive and above inductive.

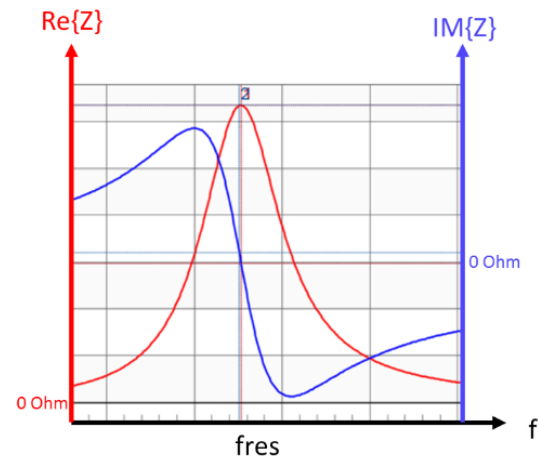

Figure 2. Impedance of a RLC Resonance Circuitry

#### Antenna Design Flow

Most commonly used antenna type for the RFID and NFC applications on the market is planar single layer coil antenna on the PCB due to easy and flexible design capability of the antenna size and low cost against external SMT/SMD inductors. The inductivity of a planar single layer coils depends on the geometrical data of the coil outline size, space, number or turns and width of the trace on the PCB. The online tool [2] provides first approximation to get the target inductivity based on the geometrical data of the coil.

As a start point for an antenna coil design the following steps need to be considered

1. Determine the input chip capacitance and design the inductivity to get the operating resonance frequency at 13.56 MHz
  - a. The internal chip capacitance of the N24RFxx varies in the range of 26 pF to 30 pF
  - b. The required inductivity using eq.1 targeted in the range of 4.7  $\mu$ H to 5.1  $\mu$ H
2. Determine the allowable antenna size and types based on the requirement of the NFC tag applications
  - a. Surface-mount inductor
  - b. Rectangular, circular or other shape of planar inductors on PCB or Flexboard
    - i. Determine size, number of turns, track width, spacing to get the required inductivity

**Simulation of PCB Coil Antenna Inductivity**

To calculate the rectangular/circular planar inductivity the online tool on the webpage [2] can be used or a circuit simulator [3] to simulate a LC network to get required resonance frequency. [2] provides already a ready to use single layer rectangular or circular component based on the geometrical parameters. The picture below shows a credit sized antenna coil with 6 turns designed based on a LC resonance circuit simulation.

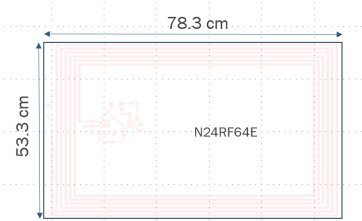

Figure 3. Credit Sized Antenna Coil



Figure 4. Resonance Circuit Simulation

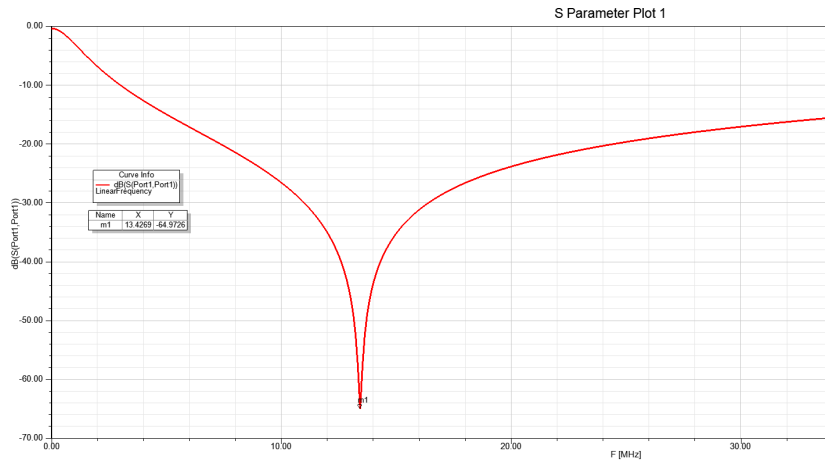

Figure 5. Resonance Frequency Simulation

The Figure 6 shows a double layer antenna simulation which shows the inductivity of 4.56  $\mu\text{H}$  and the resonance frequency at  $\sim 13.6$  MHz.

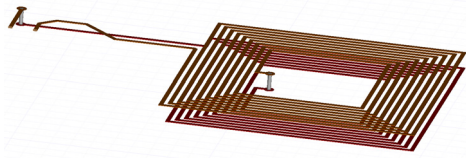

Figure 6. Double Layer Antenna Simulation with Ansys HFSS

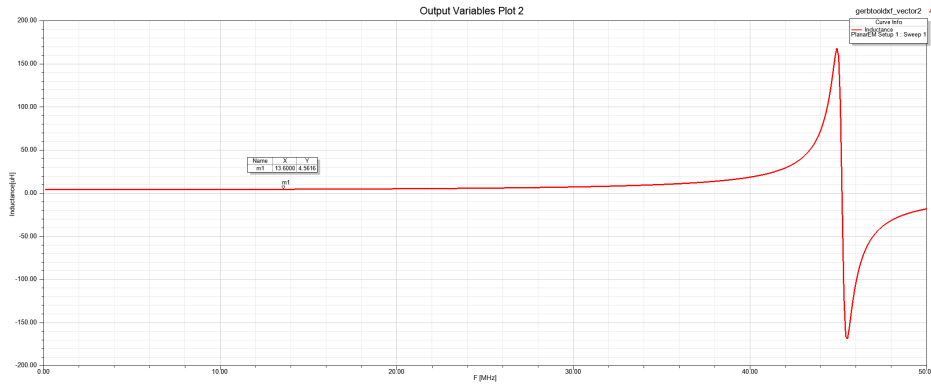

Figure 7. Inductivity of the Double Layer NFC Antenna with  $L = 4.56 \mu\text{H}$  @ 13.6 MHz

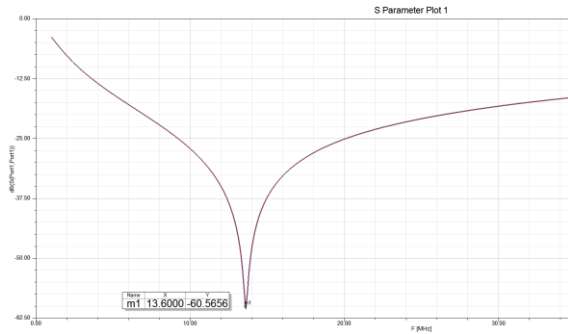
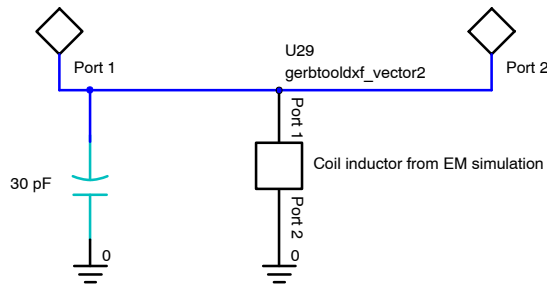
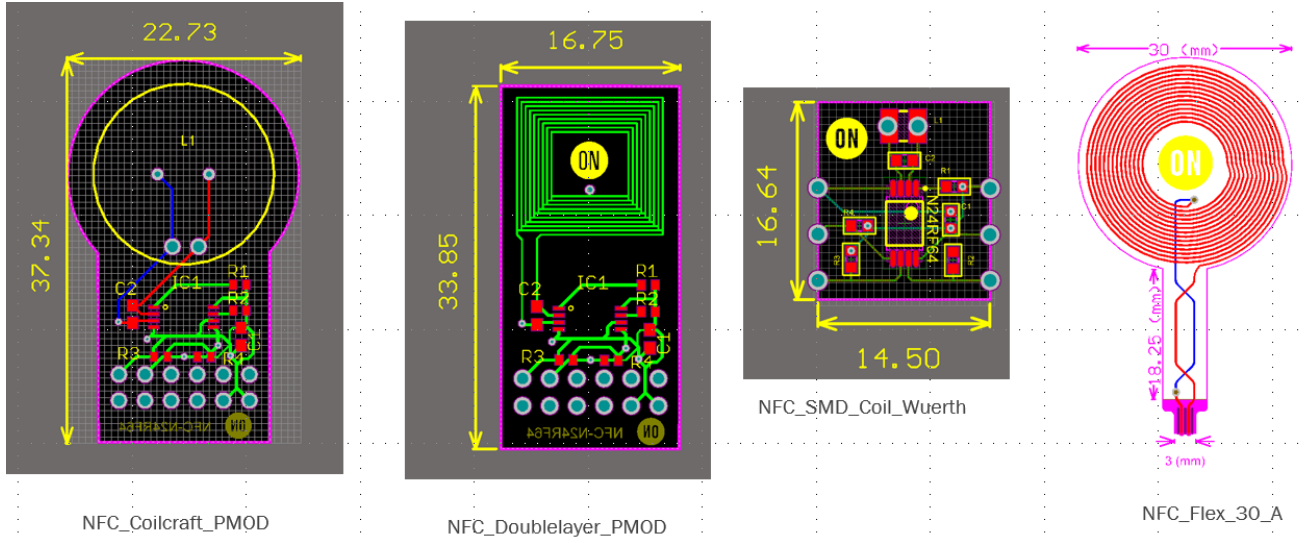

Figure 8. Double Layer Coil Inductor and Resonance Frequency Simulation

**NFC Evaluation Board Prototypes with Different Antenna Concepts**

The pictures below shows different layout of the N24RFxx evaluation boards with different antenna types

SMT coil, double layer PCB antenna and circular flexboard antenna.







**Figure 9. NFC Evaluation Boards**

The final evaluation boards have been tested with a Samsung Galaxy Smartphone using a NFC android app to verify the communication distances. The evaluation board with the small sized SMD coil needs to be located as close

to the smartphone as possible in order to read the N24RFxx UID.

The other boards with SMT coil and PCB antennas showed the reading distance up to 1 cm.

**Table 1.**

|   | Antenna Type       | Communication Range | Board Size         | Comment  |
|---|--------------------|---------------------|--------------------|--|
|  | Wuerth SMD coil    | ~0.1 cm             | 14.5 x 16.6 mm     | Smallest antenna size but poor communication range |
|  | Coilcraft SMT coil | ~1 cm               | 22.73 x 37.3 mm    | PMOD interface I <sup>2</sup> C                    |
|  | PCB double layer   | ~1 cm               | 16.75 x 33 x 85 mm | PMOD interface I <sup>2</sup> C                    |
|  | PCB rectangular    | ~1 cm               | 60 x 20 mm         | Evaluation Board                                   |
|  | Circular           | ~1 cm               | 30 mm diameter     | Flex pcb antenna                                   |

The picture below shows the NFC shield attached to the IDK IoT baseboard via PMOD interface for the I<sup>2</sup>C communication. The memory of the EEPROM can be

written and read either via I<sup>2</sup>C or RF interface via the antenna coil and demonstrates an IoT application using double interface EEPROM capability on the NFC shield.



Figure 10. NFC Shield Attached to the IDK Baseboard

**Design and Development of Credit Sized NFC Evaluation Board**

This chapter describes a simple NFC application board with a rectangular antenna coil in the size of a credit card.

The outline size of the antenna coil is selected in the range of a standard credit size about ~7.7 mm x 5.2 mm.

With the required size, the number of turns, width and space of the trace need to be selected to get the required inductivity in the range of 4.6  $\mu\text{H}$  to 5.2  $\mu\text{H}$ .

Simulating with [3] outputs the geometrical data of the rectangular coil characteristics:

Outline coil size 7.5 x 5 cm, number of turns = 6, width and space of the trace = 0.6 cm an inductivity value about 5.1  $\mu\text{H}$ . On the Vout pin [1] a LED has been connected to demonstrate the Energy Harvesting capability of the device. Once a NFC reader or smartphone with NFC capability is put near the antenna coil, the LED will light up with the supplied voltage on the Vout pin.

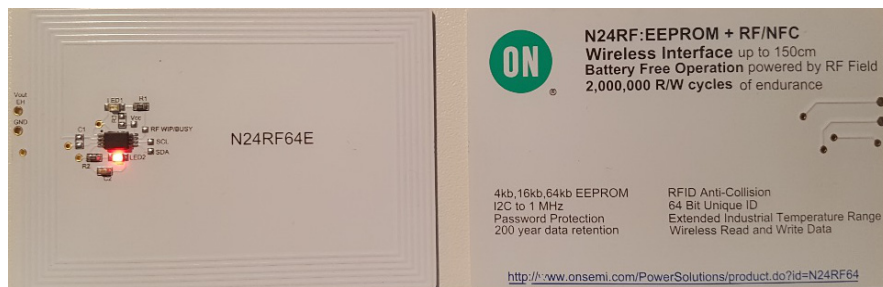

Figure 11. N24RF64E with Energy Harvesting

The reading distance depends on the NFC Reader and its magnetic field to power up a NFC device in the proximity. According to Ampere’s law current flowing in a conductor produces a magnetic field around the conductor. The magnetic field of a reader antenna, in most cases circular or rectangular loop antenna depends on the geometrical structure, current flowing through the conductor, number of turns and the distance  $d$  from the antenna whereby the magnetic field strength decays approximately with  $\sim 1/d^3$ .

To demonstrate the reading distance of the credit sized antenna following measurement has been carried out.

The operating magnetic field of N24RFxxE is specified according [1] from 150 to 5000 mA/m.

Two readers were used, a Samsung Galaxy S7 smartphone and a CPR30 standalone desktop reader from Feig. The Feig CPR30 has greater transmission output power than the smartphone at 100mW.

From the measurement with a spectrum analyzer, the magnetic field, generated by the smartphone reader, at 1 cm is about 177 mA/m with max reading distance about 2 cm whereas the magnetic field of the standalone reader CPR30 is about 460 mA/m with maximum reading distance about 6 cm. This measurement shows the magnetic field strength of a standard smartphone and a standalone NFC reader with higher transmitting output power and higher reading distance.



Figure 12. Magnetic Field Measurement at the Distance 1cm

**Table 2. READER TRANSMITTING POWER**

|                   | Pout                  | Magnetic Field at 1 cm | Reading distance of the Credit Sized Board |
|-------------------|-----------------------|------------------------|--|
| Feig CPR30        | 100 mW                | ~460 mA/m              | 6 cm                                       |
| Samsung Galaxy S7 | ~ measured 15 mW peak | ~177 mA/m              | 2 cm                                       |

**Design and Development of a NFC Sticker Board**

The following section describes the design of a sticker type inlay board with the following geometrical characteristics:

The specified outline size is about 40 x 40 mm, from the required outline size, the width and gap of the trace about 0.4 mm and the number of the turns 8 have been selected to get the required inductivity about 5 μH.

**Antenna Quality Factor**

The quality factor Q of a resonance circuits antenna is defined by the equation

$$Q = \frac{f_{res}}{f_{BW}} \tag{eq. 2}$$

Whereby  $f_{BW} = f_2 - f_1$  is the 3 dB bandwidth of the antenna.

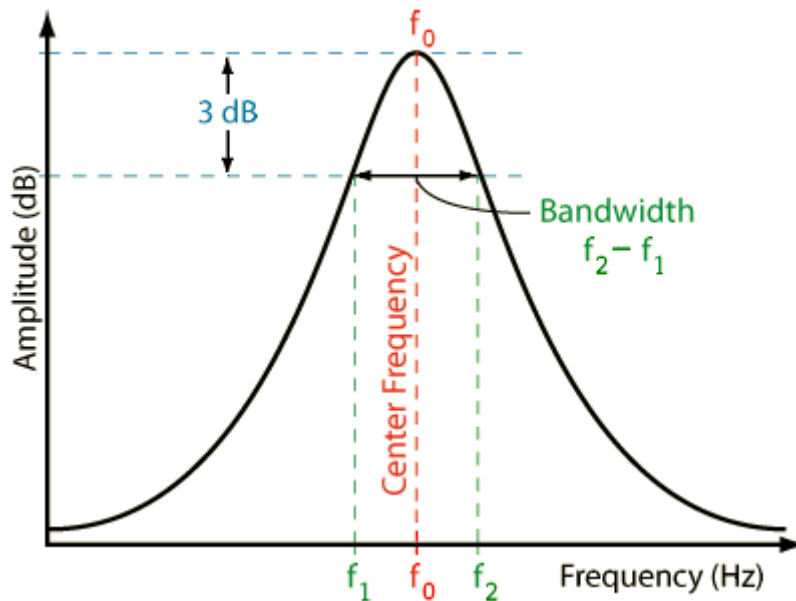

**Figure 13. Quality Factor**

A high quality factor means lower or narrower bandwidth but higher output power for the antenna and vice versa.

Therefore, by selecting the Q factor and resonance frequency, the bandwidth to cover the subcarriers on the one hand and the output power to meet the magnetic field strength from  $H_{min} = 150 \text{ mA} < H_{ISO} < H_{max} = 5 \text{ A/m}$  according to ISO 15693 [4] need to be considered during the antenna design.

**ISO 15693 Compliant NFC Reader**

Besides a smartphone with NFC capability, a standalone NFC reader supporting ISO 15693 standard can be taken to read and write the memory of N24RFxxE.

The two readers from Feig, listed in the table, have been verified to write and read the memory of N24RFxxE via RF interface with reading distance of about ~10 cm due to higher output power of the reader

**Table 3.**

| Feig Reader Supporting ISO 15693 | Demo Software | Pout   |
|----------------------------------|---------------|--------|
| CPR30                            | CPRStart 2018 | 100 mW |
| ISC.MR102                        | ISOStart 2018 | 1.2 W  |

1. The CPR30 needs to use the latest firmware

Reference

[1] [N24RF64E-D.PDF](#)

[2] [http://www.circuits.dk/calculator\\_planar\\_coil\\_inductor.htm](http://www.circuits.dk/calculator_planar_coil_inductor.htm)

[3] Ansys HFSS

[4] ISO-15963-2 Part2: Radio frequency power and signal interface

ON Semiconductor is licensed by the Philips Corporation to carry the I<sup>2</sup>C bus protocol.

ON Semiconductor and  are trademarks of Semiconductor Components Industries, LLC dba ON Semiconductor or its subsidiaries in the United States and/or other countries. ON Semiconductor owns the rights to a number of patents, trademarks, copyrights, trade secrets, and other intellectual property. A listing of ON Semiconductor's product/patent coverage may be accessed at [www.onsemi.com/site/pdf/Patent-Marking.pdf](http://www.onsemi.com/site/pdf/Patent-Marking.pdf). ON Semiconductor reserves the right to make changes without further notice to any products herein. ON Semiconductor makes no warranty, representation or guarantee regarding the suitability of its products for any particular purpose, nor does ON Semiconductor assume any liability arising out of the application or use of any product or circuit, and specifically disclaims any and all liability, including without limitation special, consequential or incidental damages. Buyer is responsible for its products and applications using ON Semiconductor products, including compliance with all laws, regulations and safety requirements or standards, regardless of any support or applications information provided by ON Semiconductor. "Typical" parameters which may be provided in ON Semiconductor data sheets and/or specifications can and do vary in different applications and actual performance may vary over time. All operating parameters, including "Typicals" must be validated for each customer application by customer's technical experts. ON Semiconductor does not convey any license under its patent rights nor the rights of others. ON Semiconductor products are not designed, intended, or authorized for use as a critical component in life support systems or any FDA Class 3 medical devices or medical devices with a same or similar classification in a foreign jurisdiction or any devices intended for implantation in the human body. Should Buyer purchase or use ON Semiconductor products for any such unintended or unauthorized application, Buyer shall indemnify and hold ON Semiconductor and its officers, employees, subsidiaries, affiliates, and distributors harmless against all claims, costs, damages, and expenses, and reasonable attorney fees arising out of, directly or indirectly, any claim of personal injury or death associated with such unintended or unauthorized use, even if such claim alleges that ON Semiconductor was negligent regarding the design or manufacture of the part. ON Semiconductor is an Equal Opportunity/Affirmative Action Employer. This literature is subject to all applicable copyright laws and is not for resale in any manner.

#### PUBLICATION ORDERING INFORMATION

##### LITERATURE FULFILLMENT:

Literature Distribution Center for ON Semiconductor  
19521 E. 32nd Pkwy, Aurora, Colorado 80011 USA  
**Phone:** 303-675-2175 or 800-344-3860 Toll Free USA/Canada  
**Fax:** 303-675-2176 or 800-344-3867 Toll Free USA/Canada  
**Email:** [orderlit@onsemi.com](mailto:orderlit@onsemi.com)

**N. American Technical Support:** 800-282-9855 Toll Free  
USA/Canada  
**Europe, Middle East and Africa Technical Support:**  
Phone: 421 33 790 2910

**ON Semiconductor Website:** [www.onsemi.com](http://www.onsemi.com)

**Order Literature:** <http://www.onsemi.com/orderlit>

For additional information, please contact your local  
Sales Representative