

# NCP1076FLBKGEVB



## NCP1076B Flyback Converter Evaluation Board User's Manual

ON Semiconductor®

[www.onsemi.com](http://www.onsemi.com)

### Universal AC Mains, Up to 18 Watt Isolated Power Supply

### EVAL BOARD USER'S MANUAL

#### Introduction

This evaluation board manual describes 18 W High voltage switching, universal AC mains Flyback converter.

The converter provides constant voltage output. The supply can be used for powering utility electric meters, white goods or similar industrial equipment where isolation from the AC mains is required. The main benefits of provided solution are high efficiency, cost effectiveness and low no-load power consumption. The converter is utilizing monolithic ON Semiconductor switcher NCP1076B with integrated 4.7  $\Omega$  MOSFET in a PDIP7 package. The design note provides complete circuit diagram and bill of materials. The current capability of provided converter is user adjustable.

#### Circuit Description

The varistor R6 together with resistor R2 form simple protection that enhances application robustness against line over-voltage and voltage spikes. Resistor R2 also limits the inrush current when the power supply is connected to mains. The EMC filter is implemented to reduce conducted electromagnetic emissions to the mains.

The Flyback converter itself is formed by the high voltage switching regulator IC1, transformer TR1, freewheeling diode D3. Capacitors C4, C5, C12 and C13 are used as the output filtering and energy storage bank. Resistor R9 and capacitor C14 for filter, C9, R1 and D8 are forming voltage clamp for the switcher drain. Optocouple OK1 and IC3 – NCP431 is used in feedback network. Resistors R13 and R14 form resistive divider and sets output voltage.

Diode D2 and resistor R7 provide supply voltage VCC for IC1 from auxiliary winding. The capacitor C18 is the energy storage element that keeps IC1 powered during light load conditions, when the switching frequency drops and energy from auxiliary winding refills VCC capacitors less often.

Pin BO/AC\_OVP is connected through resistor divider formed by R5, R15, R16 and R17 to bulk voltage and sets

Brown-out function, AC line over-voltage protection and over-power protection.

The frequency compensation of the feedback loop system is ensured by external capacitor C10 that is connected to the IC OTA output.

#### Key Features

- Universal AC Input Range (85 – 265 Vac)
- Input Filter for Conducted EMI Attenuation
- Very Low Standby and No-load Power Consumption
- Frequency Fold-back for Improved Efficiency at Light Load
- Inherent Over-current, Over-voltage and Over-temperature Protections
- Frequency Jittering for Better EMI Signature
- Adjustable Peak Current to Set the Required Level of Over-current Protection
- Adjustable Brown-out Function

Table 1.

Description	Output Specification
Output Voltage	12 Vdc
Output Ripple	< 100 mV @ Full Load
Nominal Output Current	1.2 A
Max Output Current	1.5 A
Min Output Current	0 A
Efficiency	See Efficiency Charts
Inrush Limiting	Inrush Resistor R2
Operating Temperature Range	0°C to 50°C
Cooling Method	Passive Cooling
No-load Power Consumption	< 60 mW @ 85 – 265 Vac

Table 2.

Device	Application	Input Voltage	Output Power	Topology	I/O Isolation
NCP1076B	White Goods, E-Meters	85 to 265 Vac	18 W	Flyback	Yes



# NCP1076FLBKGEVB

## EVALUATION BOARD

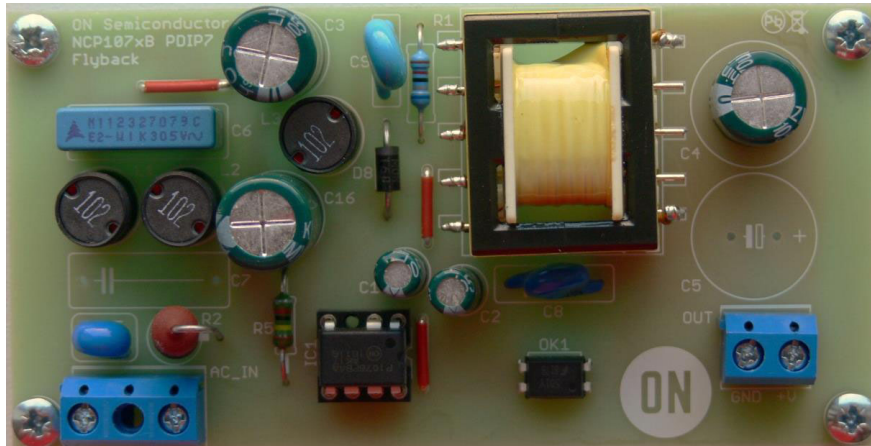

Figure 4. Evaluation Board – Top Side

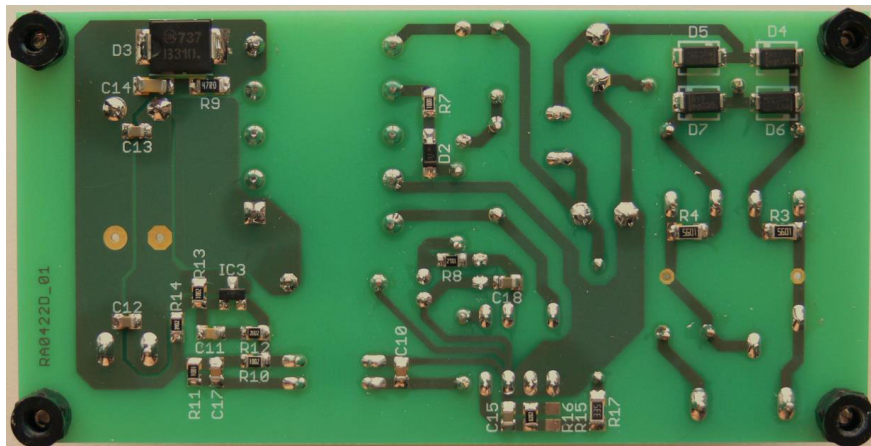

Figure 5. Evaluation Board – Bottom Side

# NCP1076FLBKGEVB

## THERMAL MEASUREMENT



Figure 6. Thermal Measurement – Top Side

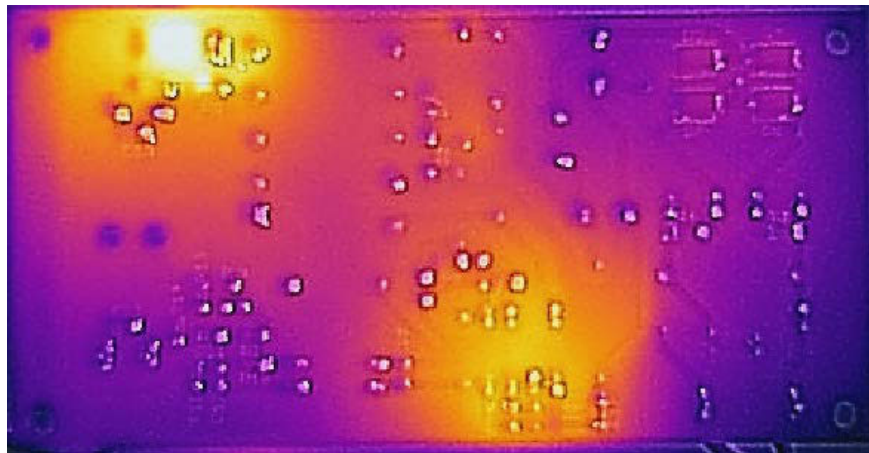

Figure 7. Thermal Measurement – Bottom Side

# NCP1076FLBKGEVB

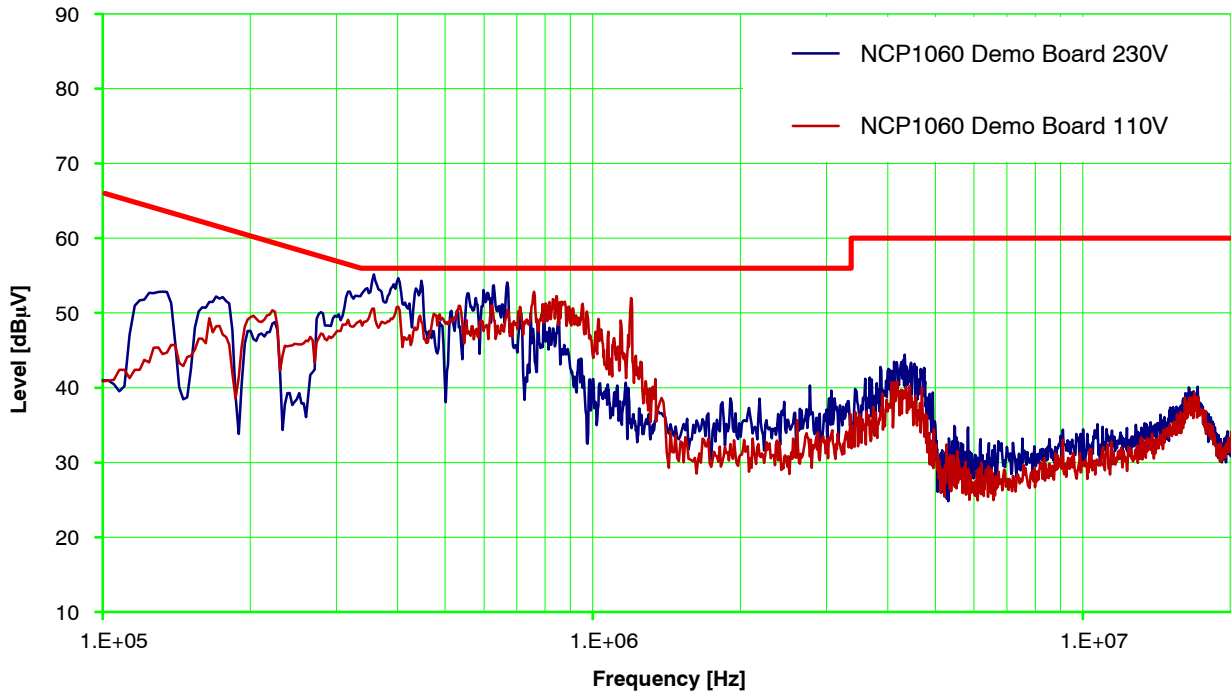

Figure 8. Conducted Emission Quasi-peak dBµV (Domestic)

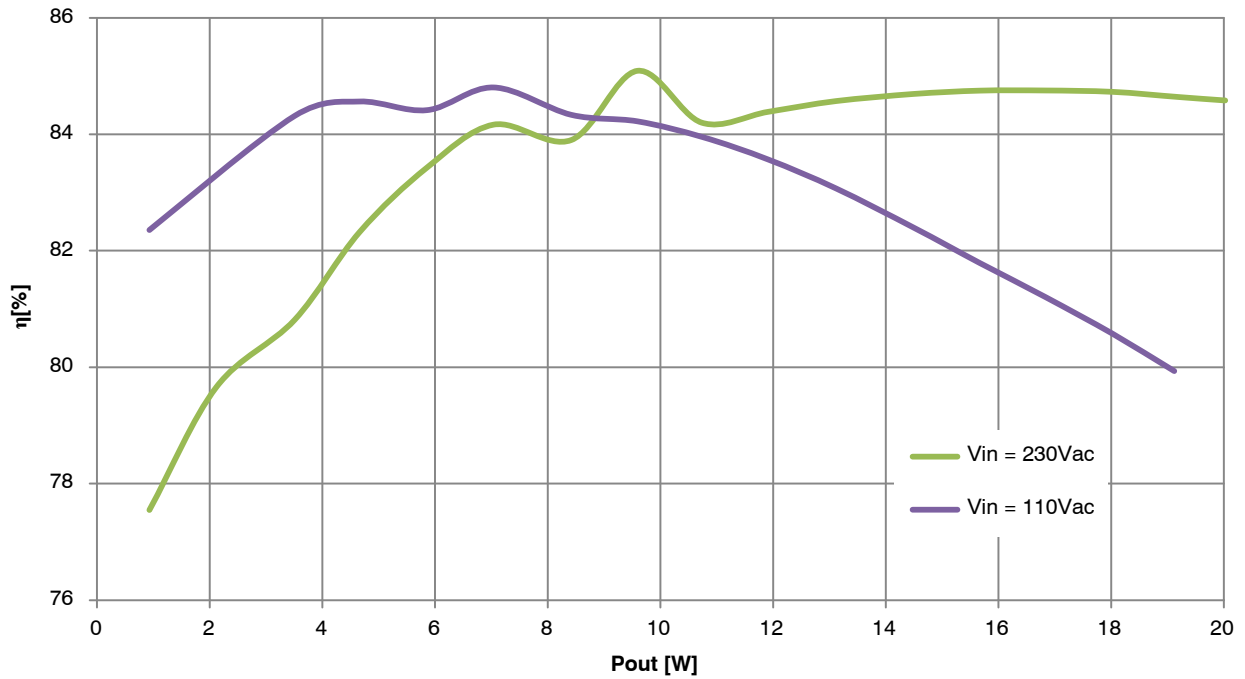

Figure 9. Efficiency vs. Output Load Curves

# NCP1076FLBKGEVB

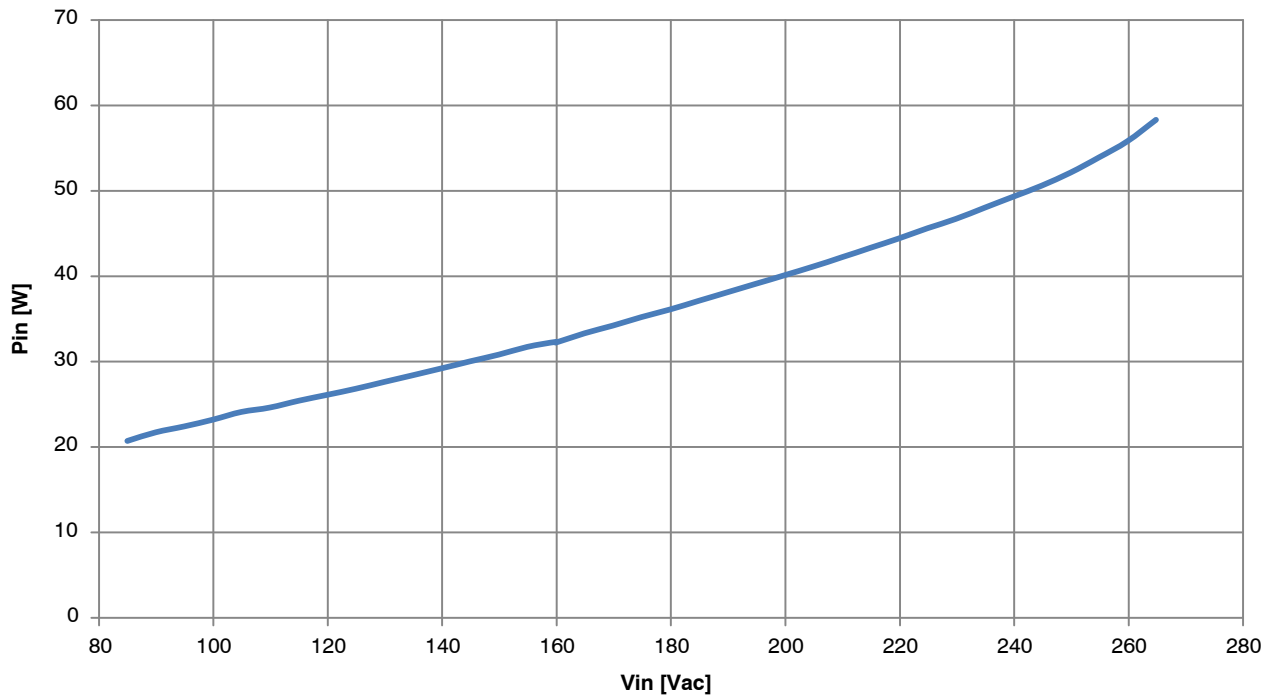

Figure 10. No-load Power Consumption vs. Line Input Curves

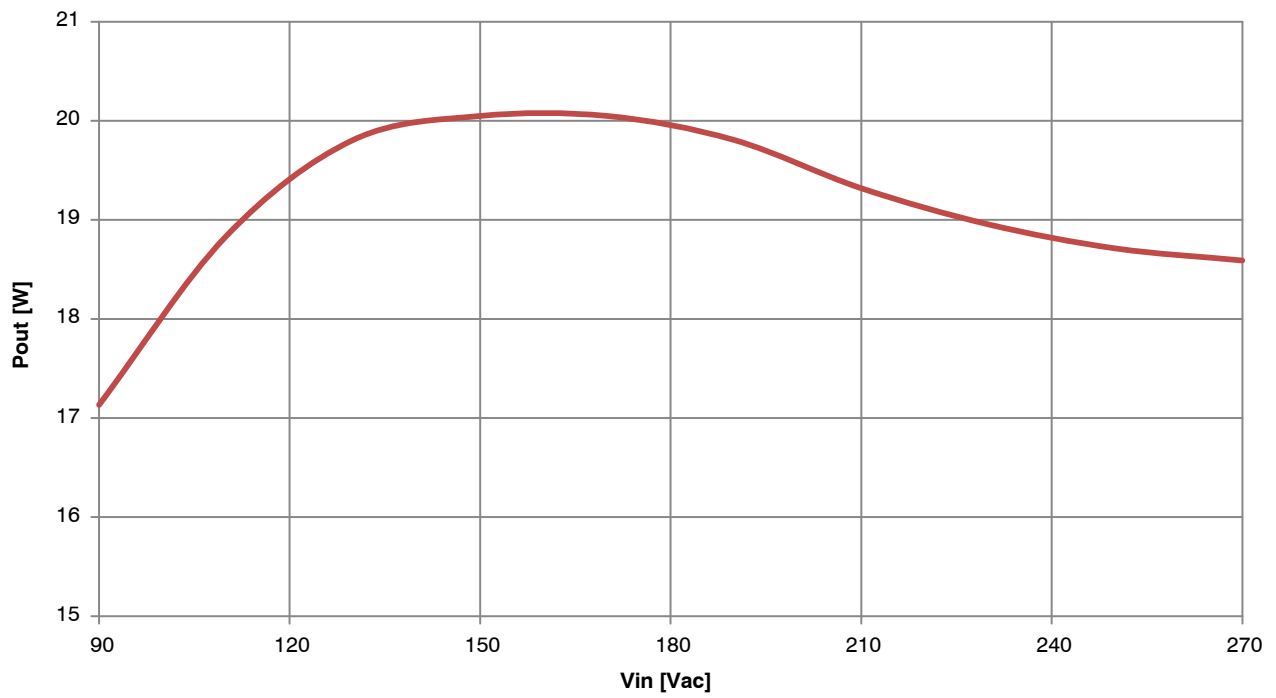

Figure 11. Maximal Output Power vs. Line Input Curves

**Brown-out Protection**

Brown-out protection prevents SMPS operating from a low input voltage when conduction losses could damage the MOSFET.

When BO/AC\_OVP pin is grounded (voltage on this pin is below  $V_{BO(EN)}$ ), then an internal comparator monitors the

drain voltage. If the drain voltage is lower than the internal threshold  $V_{HV(EN)}$  (91 V dc typically), the internal power switch is inhibited. If BO/AC\_OVP pin is connected to bulk voltage via resistive divider then function Line detection is inhibited and the IC starts switching when on BO/AC\_OVP pin reach  $V_{BO(ON)}$ .

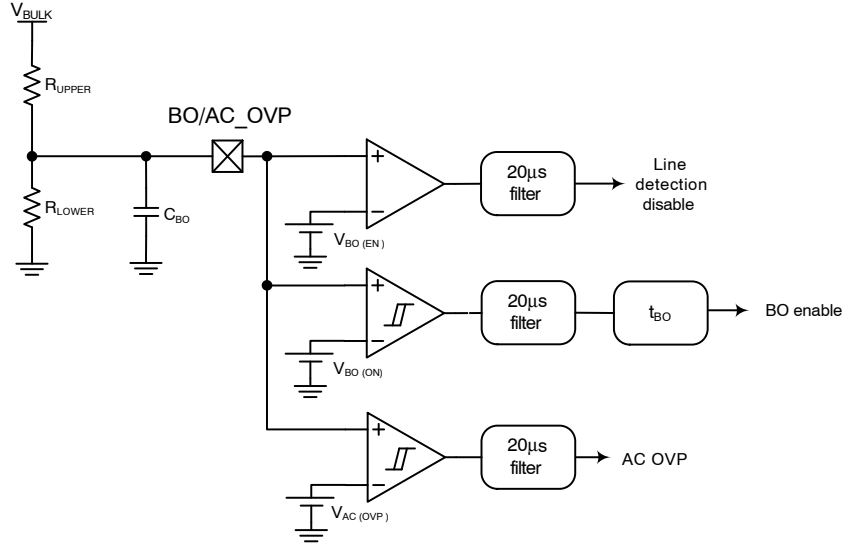

**Figure 12. A Resistive Divider Made of  $R_{UPPER}$  and  $R_{LOWER}$ , brings a Portion of the HV Rail on BO/AC\_OVP Pin**

In this application  $R_{UPPER}$  is serial combination of R5 and R17,  $R_{LOWER}$  is R16.

Calculation of the resistive divider:

$$\frac{R_{LOWER}}{R_{UPPER}} = \frac{V_{BO(ON)}}{V_{BULK} - V_{BO(ON)}}$$

If we decide to start pulsing at  $V_{BULK(ON)} = 113$  V dc (80 V rms at ac mains):

$$\frac{R_{LOWER}}{R_{UPPER}} = \frac{V_{BO(ON)}}{V_{BULK} - V_{BO(ON)}} = \frac{0.8}{113 - 0.8} \approx 7.1 \text{ m}$$

We choose  $R_{LOWER} = R16 = 82$  k $\Omega$

$$R_{UPPER} = R5 + R17 = \frac{82 \cdot 10^3}{7.1 \cdot 10^{-3}} = 11.5 \text{ M}\Omega = 8.2 \text{ M}\Omega + 3.3 \text{ M}\Omega$$

It is better to connect capacitor with lower value on BO/AC\_OVP pin because on capacitor with higher value there is lower ripple but average voltage value. It means the IC could start switching at 80 Vac but it stops switching at 75 Vac not at 70 Vac – lower hysteresis. If there is lower capacitor then ripple is higher but if voltage peak reach  $V_{BO(OFF)}$  value each  $t_{BO} = 50$  ms minimal then the IC doesn't stop switching.

**AC Line OVP**

AC line overvoltage protection is a mean to prevent SMPS operating at high input voltage. This protection is set the same resistive divider as Brown-out protection.

If the voltage on BO/AC\_OVP pin exceed  $V_{AC(OVP)}$ , the switcher immediately stops pulsing until the voltage on BO/AC\_OVP pin drops under  $V_{AC(OVP)}$ . For  $V_{BULK(ON)} = 113$  V dc will be over-voltage protection (voltage when the switcher stops pulsing):

$$V_{BULK(OVP)} = V_{AC(OVP)} \cdot \frac{R_{LOWER} + R_{UPPER}}{R_{LOWER}} = V_{AC(OVP)} \cdot \frac{V_{BULK(ON)}}{V_{BO(ON)}} = 2.9 \cdot \frac{113}{0.8} = 409 \text{ Vdc}$$

It corresponds to 290 V rms. SMPS starts switching again when bulk voltage drops down to:

$$V_{AC(OVP)} \cdot \frac{V_{BULK(ON)}}{V_{BO(ON)}} = 2.6 \cdot \frac{113}{0.8} = 367 \text{ Vdc} = 260 \text{ Vrms}$$

Then power losses on resistive divider for worst case ( $V_{BULK} = 409$  V dc)

$$P = U \cdot I = \frac{U^2}{R} = \frac{U^2}{R_{UPPER} + R_{LOWER}} = \frac{409^2}{11.5 \cdot 10^6 + 82 \cdot 10^3} \approx 15 \text{ mW}$$

# NCP1076FLBKGEVB

## Over-power Protection

Over-power protection is internal function using the bulk voltage to program the maximum current reduction for a given input voltage. Internal OPP is active when BO/AC\_OVP pin is connected via resistive divider to the bulk voltage. At 0.8 V on BO/AC\_OVP pin the peak current is not reduced, if the same voltage rises to 2.65 V then the peak current is reduced by 20%, in this application it corresponds to 375 V dc bulk voltage. On the Maximal Output Power vs. Line Input Curves graph you can see dependence of output power on line input curves.

## 2<sup>nd</sup> LEB – Peak Current Protection

There is a second level of current protection with 100 ns propagation delay to prevent IC against high peak current.

It could prevent destruction when forward diode on secondary side or transformer is shorted. If peak current is 150% max peak current limit, then the controller stops switching after three pulses and waits for an auto-recovery period ( $t_{recovery}$ ) before attempting to re-start.

## Startup and 2<sup>nd</sup> LEB

In Flyback topology there are pulses with higher value before soft-start. If the pulse value reaches 150%  $I_{PK}$  then the IC stops switching and it couldn't start to normal operation. The maximal value could be affected by output capacitor value, transistor inductance or turns ratio or secondary side diode forward voltage.

## OUTPUT RIPPLE VOLTAGE

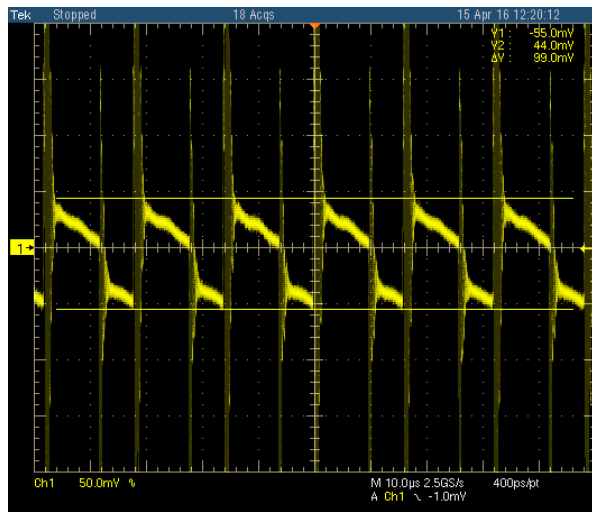

Figure 13. Input Voltage 90 Vac and 1.2 A Load

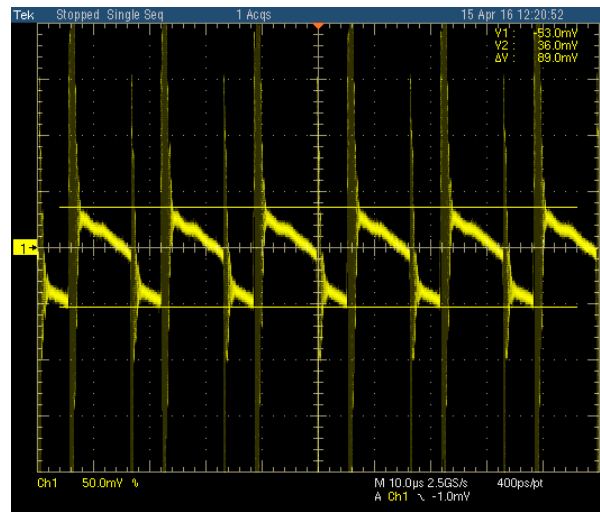

Figure 14. Input Voltage 110 Vac and 1.2 A Load

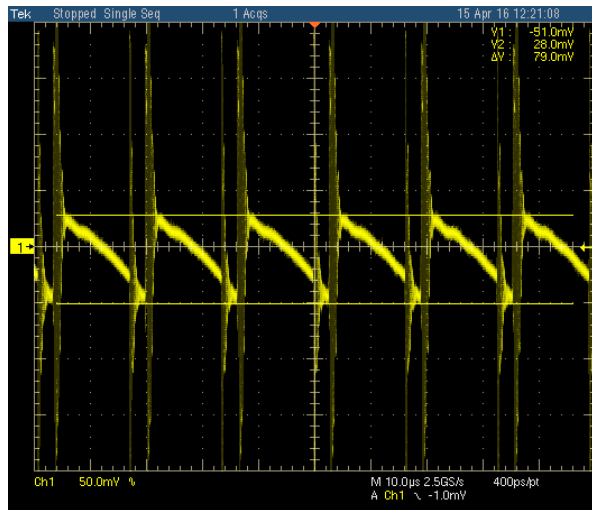

Figure 15. Input Voltage 230 Vac and 1.2 A Load

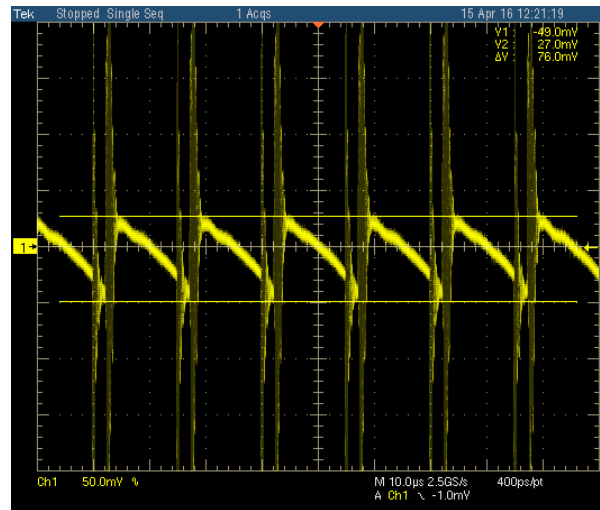

Figure 16. Input Voltage 265 Vac and 1.2 A Load



# NCP1076FLBKGEVB

## TRANSIENT RESPONSE

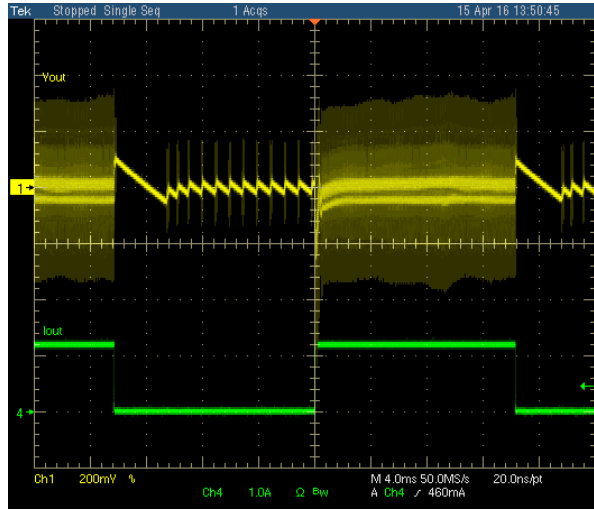

Figure 17. Test Condition: 30–1200 mA, 28 ms Cycle, 110 Vac

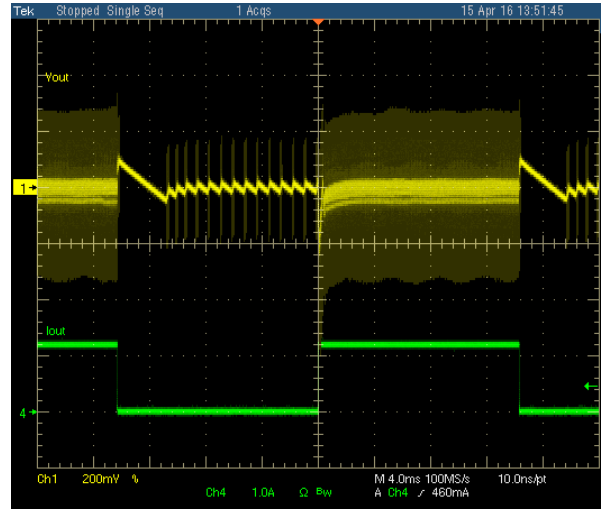

Figure 18. Test Condition: 30–1200 mA, 28 ms Cycle, 230 Vac

# NCP1076FLBKGEVB

## STARTUP TIME

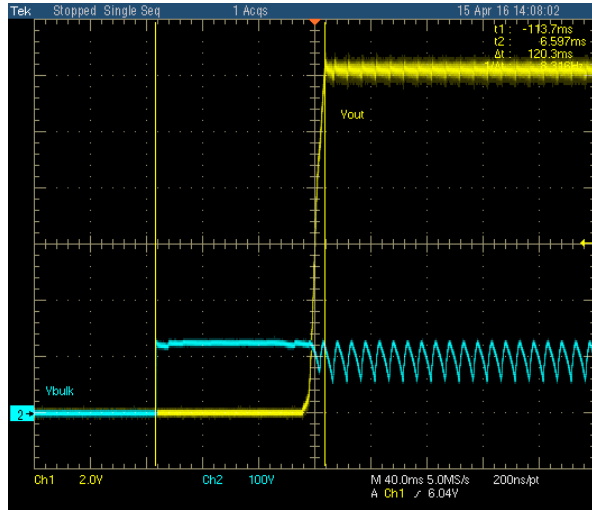

Figure 19. Input Voltage 90 Vac and 1.2 A Load

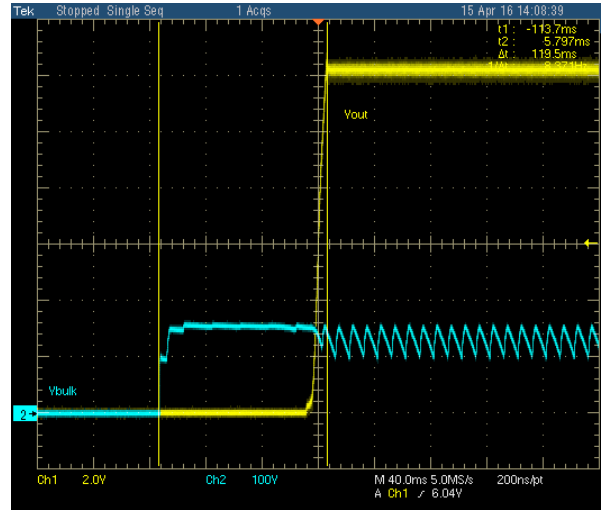

Figure 20. Input Voltage 110 Vac and 1.2 A Load

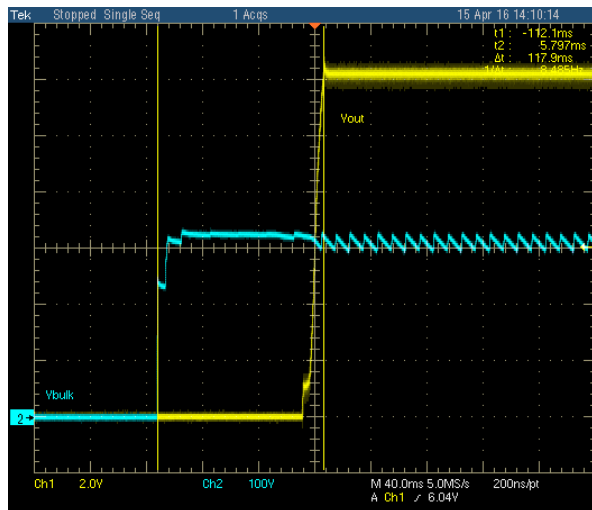

Figure 21. Input Voltage 230 Vac and 1.2 A Load

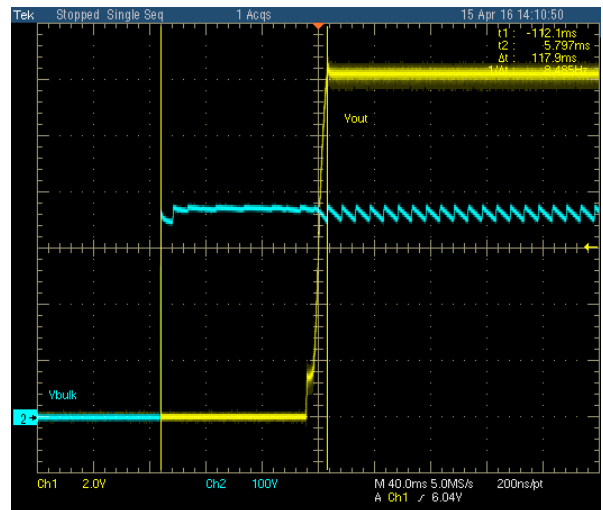

Figure 22. Input Voltage 265 Vac and 1.2 A Load

# NCP1076FLBKGEVB

## STARTUP AND 2<sup>nd</sup> LEB PROTECTION

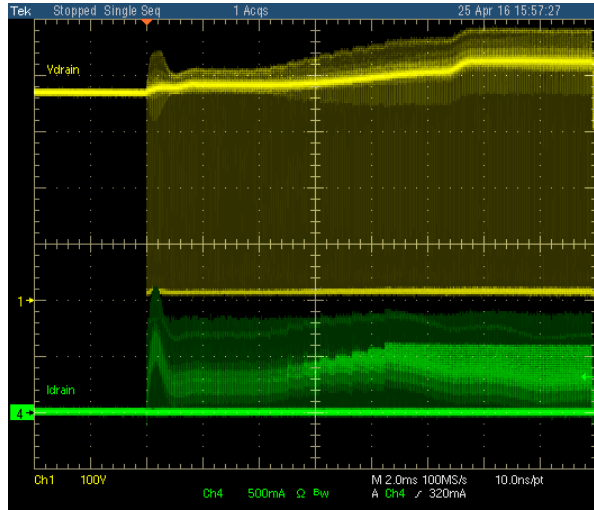

Figure 23. 265 Vac 1.2 A Load

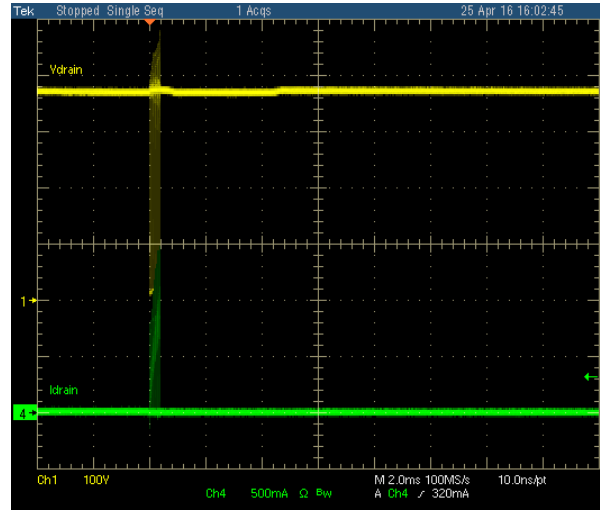

Figure 24. 265 Vac Short-circuit

## OVER-CURRENT PROTECTION

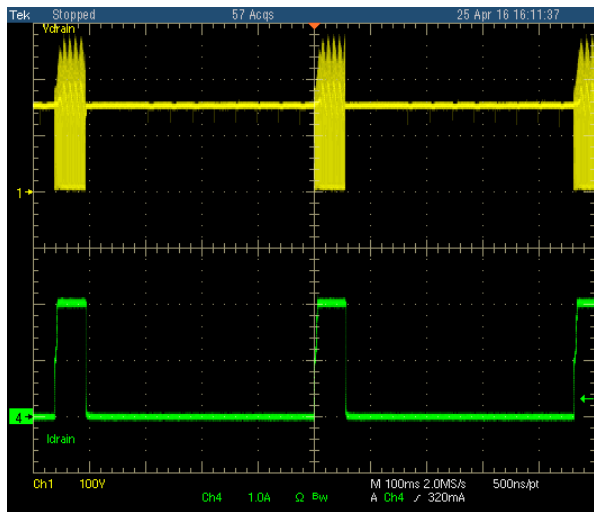

Figure 25. 110 Vac 2 A Load

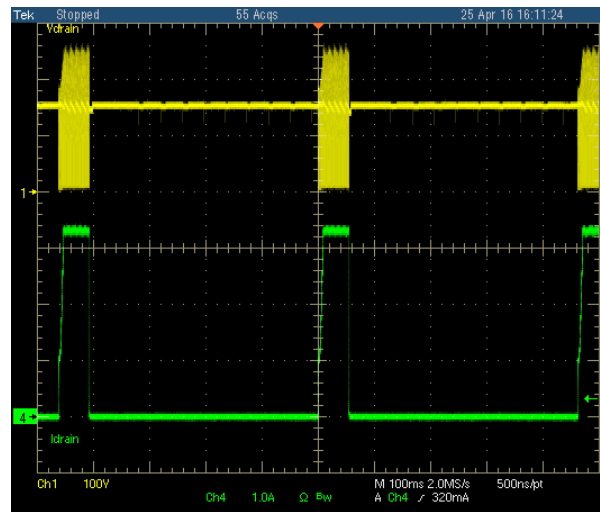

Figure 26. 110 Vac 3.5 A Load

# NCP1076FLBKGEVB

## POWER OFF

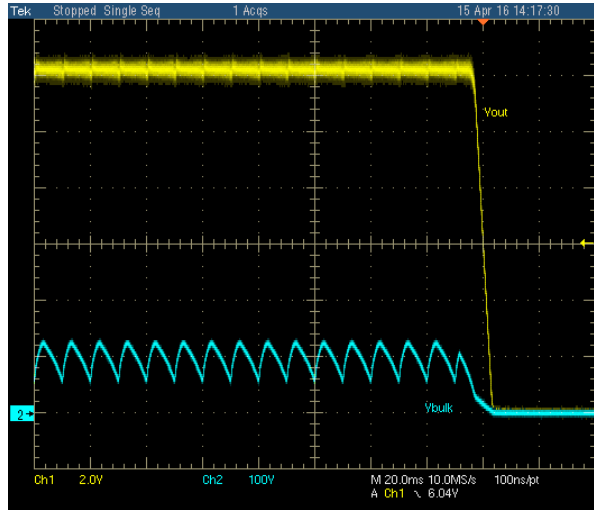

Figure 27. Input Voltage 90 Vac and 1.2 A Load

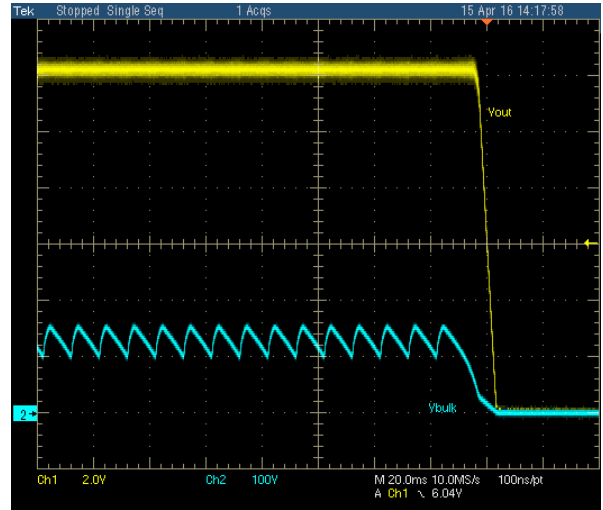

Figure 28. Input Voltage 110 Vac and 1.2 A Load

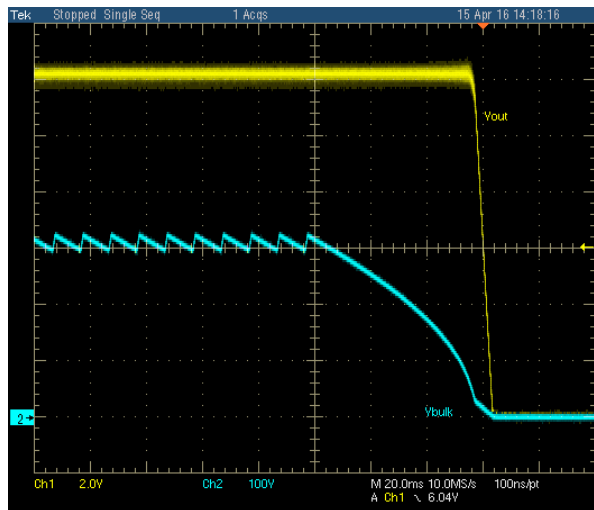

Figure 29. Input Voltage 230 Vac and 1.2 A Load

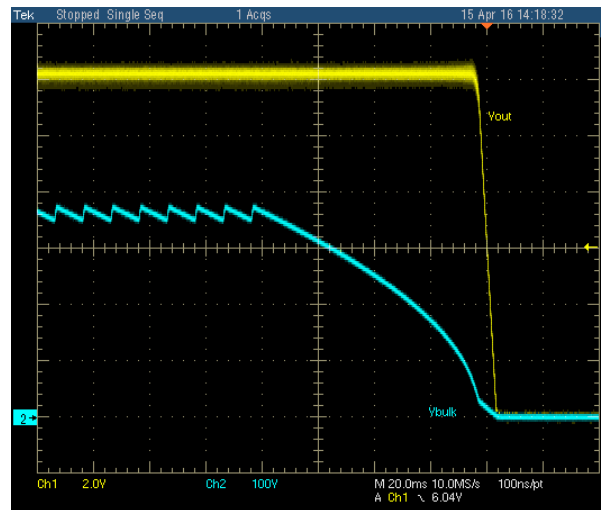

Figure 30. Input Voltage 265 Vac and 1.2 A Load

# NCP1076FLBKGEVB

## BROWN-OUT

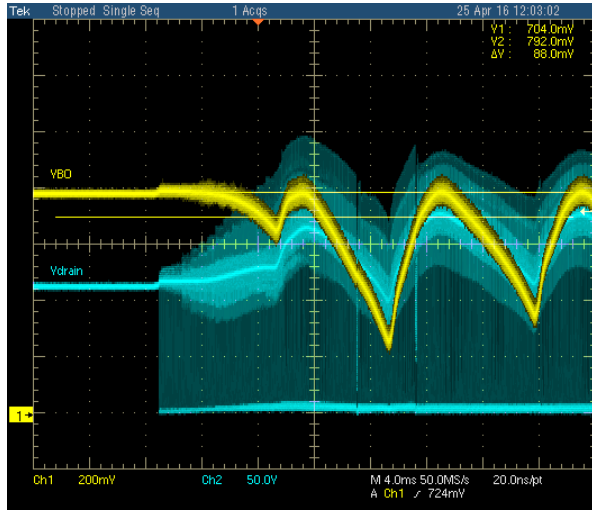

Figure 31. 82 Vac 1 A Load

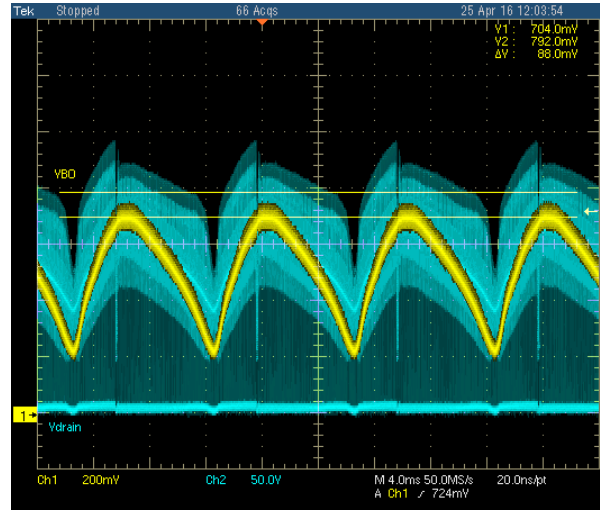

Figure 32. 73 Vac 1 A Load

# NCP1076FLBKGEVB

**Table 3. BILL OF MATERIALS**

Designator	Qty	Description	Value	Tolerance	Footprint	Manufacturer	Manufacturer Part Number	Substitution Allowed
C1, C12, C13	3	CAPACITOR	100 nF	10%	0805	Kemet	C0805C104K5RACTU	Yes
C2	1	ELECTROLYTIC CAPACITOR	4.7 $\mu$ F / 50 V	20%	THROUGH HOLE	Würth Elektronik	860020672008	Yes
C3, C16	2	ELECTROLYTIC CAPACITOR	10 $\mu$ F / 400 V	20%	THROUGH HOLE	Würth Elektronik	8.60021E+11	Yes
C4	1	ELECTROLYTIC CAPACITOR	470 $\mu$ F / 16 V	20%	THROUGH HOLE	Würth Elektronik	860010374012	Yes
C5	1	ELECTROLYTIC CAPACITOR	NU	-	THROUGH HOLE	-	-	-
C6	1	CAPACITOR X2	100 nF	10%	THROUGH HOLE	Kemet	R463I310050M1K	Yes
C7	1	CAPACITOR X2	NU	-	THROUGH HOLE	-	-	-
C8, C9, C10, C17, C15	5	CAPACITOR	1 nF	10%	0805	Kemet	C0805X104K1RACTU	Yes
C11	1	CAPACITOR	10 nF	10%	0805	Kemet	C0805C103K5RACAUTO	Yes
C14	1	CAPACITOR	1 nF	10%	1206	Kemet	C1206C104K5RACTU	Yes
C18	1	CAPACITOR	22 $\mu$ F / 25 V	20%	THROUGH HOLE	Würth Elektronik	860010472003	Yes
D2	1	DIODE	MMSD4148	-	SOD-123	ON Semiconductor	MMSD4148	No
D3	1	DIODE	MBRS3100T3	-	SMC	ON Semiconductor	MBRS3100T3	No
D4, D5, D6, D7	4	DIODE	MRA4007	-	SMA	ON Semiconductor	MRA4007T3G	No
D8	1	DIODE	MUR160	-	THROUGH HOLE	ON Semiconductor	MURA160T3G	No
IC1	1	SWITCHER	NCP1076B	-	PDIP7	ON Semiconductor	NCP1076B	No
IC3	1	VOLTAGE REGULATOR	NCP431	1%	SOD-23-3	Würth Elektronik	NCP431	No
L1	1	INDUCTOR	1 mH	-	THROUGH HOLE	Würth Elektronik	744772102	No
L2	1	INDUCTOR	1 mH	-	THROUGH HOLE	Würth Elektronik	744772102	No
L3	1	INDUCTOR	1 mH	-	THROUGH HOLE	Würth Elektronik	744772102	No
OK1	1	OPTOCOUPLER	PC817	-	DIP-4	Rohm Semiconductor	PC817B	No
R1	1	RESISTOR	68 k $\Omega$	1%	THROUGH HOLE			Yes
R2	1	RESISTOR	20 $\Omega$	5%	THROUGH HOLE			Yes
R3, R4	2	RESISTOR	5.6 k $\Omega$	1%	1206	Vishay	CRCW12065K60FKEAHP	Yes
R5	1	RESISTOR	8.2 M $\Omega$	5%	THROUGH HOLE			Yes
R6	1	VARISTOR	SO5K275	-	THROUGH HOLE			No
R7	1	RESISTOR	10 $\Omega$	1%	0805	Vishay	CRCW080510R0FKEA.	Yes
R8	1	RESISTOR	5.1 k $\Omega$	5%	0805	Vishay	CRCW08055K10JNEA	Yes
R9	1	RESISTOR	47 $\Omega$	1%	1206	Vishay	CRCW120647R0FKEA	Yes
R10, R13	2	RESISTOR	10 k $\Omega$	1%	0805	Vishay	CRCW080510K0FKEAHP	Yes
R11	1	RESISTOR	1 k $\Omega$	1%	0805	Vishay	CRCW08051K00FKTA	Yes

# NCP1076FLBKGEVB

**Table 3. BILL OF MATERIALS**

Designator	Qty	Description	Value	Tolerance	Footprint	Manufacturer	Manufacturer Part Number	Substitution Allowed
R12	1	RESISTOR	20 kΩ	1%	0805	Vishay	CRCW080520K0FKEA	Yes
R14	1	RESISTOR	39 kΩ	1%	0805	Vishay	CRCW080539K0JNEA	Yes
R15	1	RESISTOR	NU	1%	0805	-	-	-
R16	1	RESISTOR	82 kΩ	1%	0805	Vishay	CRCW080582K0JNEA	Yes
R17	1	RESISTOR	3.3 MΩ	1%	1206	Vishay	CRCW12063M30FKEA	Yes
TR1	1	TRANSFORMER	750313861	-	THROUGH HOLE	Würth Elektronik	750313861	No
X1 (AC_IN)	1	WAGO SCREW CLAMP	691213710003	-	THROUGH HOLE	Würth Elektronik	691213710003	No
X2 (OUT)	1	WAGO SCREW CLAMP	691211720002	-	THROUGH HOLE	Würth Elektronik	691211720002	No

NOTE All components are lead free.

## REFERENCES

- [1] ON Semiconductor datasheet for NCP1076B monolithic switcher
- [2] ON Semiconductor design notes [DN05012](#), [DN05017](#), [DN05018](#), [DN05028](#), [DN05029](#)
- [3] Würth Electronic <http://www.we-online.com/>

## Disclaimer

ON Semiconductor is providing this Evaluation Board Manual “AS IS” and does not assume any liability arising from its use; nor does ON Semiconductor convey any license to its or any third party’s intellectual property rights. This document is provided only to assist customers in

evaluation of the referenced circuit implementation and the recipient assumes all liability and risk associated with its use, including, but not limited to, compliance with all regulatory standards. ON Semiconductor may change any of its products at any time, without notice.

ON Semiconductor and the ON Semiconductor logo are trademarks of Semiconductor Components Industries, LLC dba ON Semiconductor or its subsidiaries in the United States and/or other countries. ON Semiconductor owns the rights to a number of patents, trademarks, copyrights, trade secrets, and other intellectual property. A listing of ON Semiconductor's product/patent coverage may be accessed at [www.onsemi.com/site/pdf/Patent-Marking.pdf](http://www.onsemi.com/site/pdf/Patent-Marking.pdf). ON Semiconductor is an Equal Opportunity/Affirmative Action Employer. This literature is subject to all applicable copyright laws and is not for resale in any manner.

The evaluation board/kit (research and development board/kit) (hereinafter the "board") is not a finished product and is as such not available for sale to consumers. The board is only intended for research, development, demonstration and evaluation purposes and should as such only be used in laboratory/development areas by persons with an engineering/technical training and familiar with the risks associated with handling electrical/mechanical components, systems and subsystems. This person assumes full responsibility/liability for proper and safe handling. Any other use, resale or redistribution for any other purpose is strictly prohibited.

The board is delivered "AS IS" and without warranty of any kind including, but not limited to, that the board is production-worthy, that the functions contained in the board will meet your requirements, or that the operation of the board will be uninterrupted or error free. ON Semiconductor expressly disclaims all warranties, express, implied or otherwise, including without limitation, warranties of fitness for a particular purpose and non-infringement of intellectual property rights.

ON Semiconductor reserves the right to make changes without further notice to any board.

You are responsible for determining whether the board will be suitable for your intended use or application or will achieve your intended results. Prior to using or distributing any systems that have been evaluated, designed or tested using the board, you agree to test and validate your design to confirm the functionality for your application. Any technical, applications or design information or advice, quality characterization, reliability data or other services provided by ON Semiconductor shall not constitute any representation or warranty by ON Semiconductor, and no additional obligations or liabilities shall arise from ON Semiconductor having provided such information or services.

The boards are not designed, intended, or authorized for use in life support systems, or any FDA Class 3 medical devices or medical devices with a similar or equivalent classification in a foreign jurisdiction, or any devices intended for implantation in the human body. Should you purchase or use the board for any such unintended or unauthorized application, you shall indemnify and hold ON Semiconductor and its officers, employees, subsidiaries, affiliates, and distributors harmless against all claims, costs, damages, and expenses, and reasonable attorney fees arising out of, directly or indirectly, any claim of personal injury or death associated with such unintended or unauthorized use, even if such claim alleges that ON Semiconductor was negligent regarding the design or manufacture of the board.

This evaluation board/kit does not fall within the scope of the European Union directives regarding electromagnetic compatibility, restricted substances (RoHS), recycling (WEEE), FCC, CE or UL, and may not meet the technical requirements of these or other related directives.

**FCC WARNING** – This evaluation board/kit is intended for use for engineering development, demonstration, or evaluation purposes only and is not considered by ON Semiconductor to be a finished end product fit for general consumer use. It may generate, use, or radiate radio frequency energy and has not been tested for compliance with the limits of computing devices pursuant to part 15 of FCC rules, which are designed to provide reasonable protection against radio frequency interference. Operation of this equipment may cause interference with radio communications, in which case the user shall be responsible, at its expense, to take whatever measures may be required to correct this interference.

ON Semiconductor does not convey any license under its patent rights nor the rights of others.

**LIMITATIONS OF LIABILITY:** ON Semiconductor shall not be liable for any special, consequential, incidental, indirect or punitive damages, including, but not limited to the costs of requalification, delay, loss of profits or goodwill, arising out of or in connection with the board, even if ON Semiconductor is advised of the possibility of such damages. In no event shall ON Semiconductor's aggregate liability from any obligation arising out of or in connection with the board, under any theory of liability, exceed the purchase price paid for the board, if any.

For more information and documentation, please visit [www.onsemi.com](http://www.onsemi.com).

---

## PUBLICATION ORDERING INFORMATION

### LITERATURE FULFILLMENT:

Email Requests to: [orderlit@onsemi.com](mailto:orderlit@onsemi.com)

ON Semiconductor Website: [www.onsemi.com](http://www.onsemi.com)

### TECHNICAL SUPPORT

North American Technical Support:

Voice Mail: 1 800-282-9855 Toll Free USA/Canada

Phone: 011 421 33 790 2910

Europe, Middle East and Africa Technical Support:

Phone: 00421 33 790 2910

For additional information, please contact your local Sales Representative