



Is Now Part of



ON Semiconductor®

To learn more about ON Semiconductor, please visit our website at
www.onsemi.com

Please note: As part of the Fairchild Semiconductor integration, some of the Fairchild orderable part numbers will need to change in order to meet ON Semiconductor's system requirements. Since the ON Semiconductor product management systems do not have the ability to manage part nomenclature that utilizes an underscore (_), the underscore (_) in the Fairchild part numbers will be changed to a dash (-). This document may contain device numbers with an underscore (_). Please check the ON Semiconductor website to verify the updated device numbers. The most current and up-to-date ordering information can be found at www.onsemi.com. Please email any questions regarding the system integration to Fairchild_questions@onsemi.com.

ON Semiconductor and the ON Semiconductor logo are trademarks of Semiconductor Components Industries, LLC dba ON Semiconductor or its subsidiaries in the United States and/or other countries. ON Semiconductor owns the rights to a number of patents, trademarks, copyrights, trade secrets, and other intellectual property. A listing of ON Semiconductor's product/patent coverage may be accessed at www.onsemi.com/site/pdf/Patent-Marking.pdf. ON Semiconductor reserves the right to make changes without further notice to any products herein. ON Semiconductor makes no warranty, representation or guarantee regarding the suitability of its products for any particular purpose, nor does ON Semiconductor assume any liability arising out of the application or use of any product or circuit, and specifically disclaims any and all liability, including without limitation special, consequential or incidental damages. Buyer is responsible for its products and applications using ON Semiconductor products, including compliance with all laws, regulations and safety requirements or standards, regardless of any support or applications information provided by ON Semiconductor. "Typical" parameters which may be provided in ON Semiconductor data sheets and/or specifications can and do vary in different applications and actual performance may vary over time. All operating parameters, including "Typicals" must be validated for each customer application by customer's technical experts. ON Semiconductor does not convey any license under its patent rights nor the rights of others. ON Semiconductor products are not designed, intended, or authorized for use as a critical component in life support systems or any FDA Class 3 medical devices or medical devices with a same or similar classification in a foreign jurisdiction or any devices intended for implantation in the human body. Should Buyer purchase or use ON Semiconductor products for any such unintended or unauthorized application, Buyer shall indemnify and hold ON Semiconductor and its officers, employees, subsidiaries, affiliates, and distributors harmless against all claims, costs, damages, and expenses, and reasonable attorney fees arising out of, directly or indirectly, any claim of personal injury or death associated with such unintended or unauthorized use, even if such claim alleges that ON Semiconductor was negligent regarding the design or manufacture of the part. ON Semiconductor is an Equal Opportunity/Affirmative Action Employer. This literature is subject to all applicable copyright laws and is not for resale in any manner.



FPF1048 IntelliMAX™ 3 A-Capable, Slew-Rate-Controlled Load Switch with True Reverse Current Blocking

Features

- Input Voltage Operating Range: 1.5 V to 5.5 V
- Typical $R_{DS(ON)}$:
 - 21 mΩ at $V_{IN}=5.5$ V
 - 23 mΩ at $V_{IN}=4.5$ V
 - 41 mΩ at $V_{IN}=1.8$ V
 - 90 mΩ at $V_{IN}=1.5$ V
- Slew Rate/Inrush Control with t_R : 2.7 ms (Typ.)
- 3 A Maximum Continuous Current Capability
- Low Off Switch Current: <1 μA
- True Reverse Current Blocking (TRCB)
- Logic CMOS IO Meets JESD76 Standard for GPIO Interface and Related Power Supply Requirements
- ESD Protected:
 - Human Body Model: >8 kV
 - Charged Device Model: >1.5 kV
 - IEC 61000-4-2 Air Discharge: >15 kV
 - IEC 61000-4-2 Contact Discharge: >8 kV

Applications

- Smart Phones, Tablet PCs
- Storage, DSLR, and Portable Devices

Description

The FPF1048 advanced load management switch targets applications requiring a highly integrated solution. It disconnects loads powered from the DC power rail (<6 V) with stringent off-state current targets and high load capacitances (up to 100 μF). The FPF1048 consists of slew-rate controlled low-impedance MOSFET switch (23 mΩ typical) and integrated analog features. The slew-rate controlled turn-on characteristic prevents inrush current and the resulting excessive voltage droop on power rails.

The FPF1048 has a True Reverse Current Blocking (TRCB) function that obstructs unwanted reverse current from V_{OUT} to V_{IN} during both ON and OFF states. The exceptionally low off-state current drain (<1μA maximum) facilitates compliance with standby power requirements. The input voltage range operates from 1.5 V to 5.5 V_{DC} to support a wide range of applications in consumer, optical, medical, storage, portable, and industrial-device power management. Switch control is managed by a logic input (active HIGH) capable of interfacing directly with low-voltage control signal / General-Purpose Input / Output (GPIO) without an external pull-down resistor.

The device is packaged in advanced, fully “green” compliant, 1.0 mm x 1.5 mm, Wafer-Level Chip-Scale Package (WLCSP) with backside lamination.

Ordering Information

Part Number	Top Mark	Switch R_{ON} (Typical) at 4.5 V_{IN}	Input Buffer	Output Discharge	ON Pin Activity	t_R	Package
FPF1048BUCX	RA	23 mΩ	CMOS	NA	Active HIGH	2.7 ms	6-Ball, WLCSP with Backside Laminate, 2x3 Array, 0.5 mm Pitch, 300 μm Balls

Application Diagram

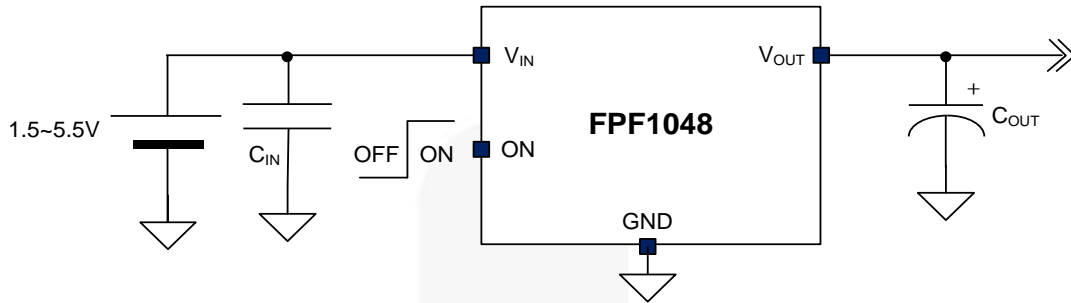

Figure 1. General Application

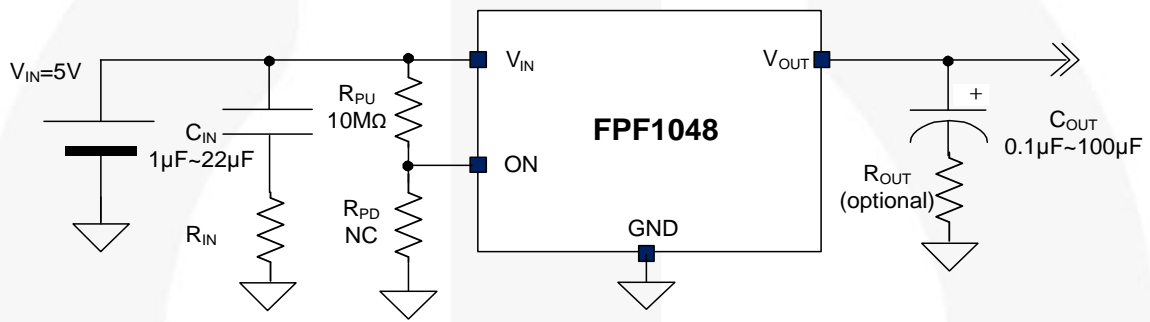

Figure 2. Specific Application with 10 MΩ Pull-Up Resistor at ON Pin

Notes:

1. Turn-on operation with a 10 MΩ pull-up resistor at ON pin is acceptable.
2. V_{IN} should be high enough to generate V_{ON} greater than V_{IH} at the ON pin.
3. NC means no connection.
4. R_{IN} and R_{OUT} can be added to reduce transient peak voltage. 1 Ω~10 Ω is recommended.

Functional Block Diagram

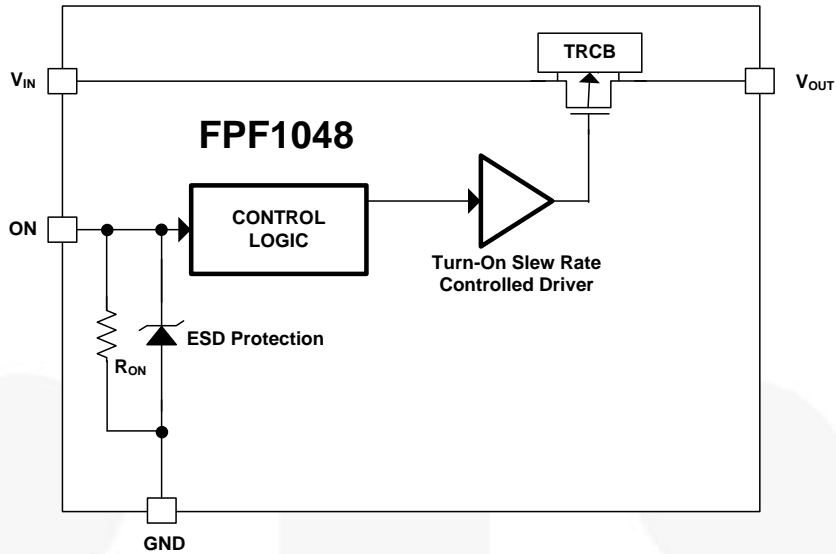

Figure 3. Functional Block Diagram

Pin Configurations

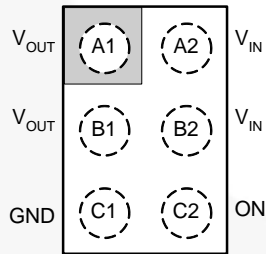
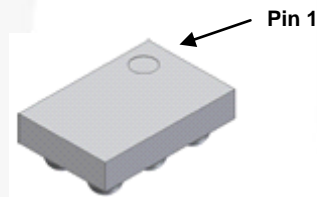

Figure 4. Pin Assignments (Top View)

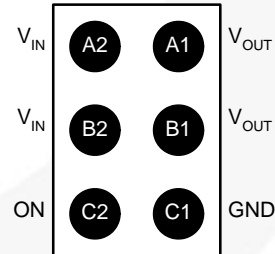
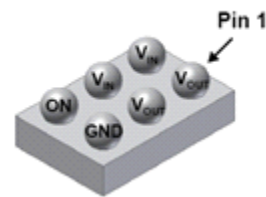

Figure 5. Pin Assignments (Bottom View)

Pin Description

Pin #	Name	Description
A1, B1	V_{OUT}	Switch Output
A2, B2	V_{IN}	Supply Input: Input to the Power Switch
C1	GND	Ground
C2	ON	ON/OFF Control, Active High, GPIO Compatible

Absolute Maximum Ratings

Stresses exceeding the absolute maximum ratings may damage the device. The device may not function or be operable above the recommended operating conditions and stressing the parts to these levels is not recommended. In addition, extended exposure to stresses above the recommended operating conditions may affect device reliability. The absolute maximum ratings are stress ratings only.

Symbol	Parameters		Min.	Max.	Unit	
V_{IN}	V_{IN} , V_{OUT} , V_{ON} to GND		-0.3	6.0	V	
I_{SW}	Maximum Continuous Switch Current			3.0	A	
P_D	Power Dissipation at $T_A=25^\circ\text{C}$			1.2	W	
T_{STG}	Storage Junction Temperature		-65	+150	$^\circ\text{C}$	
T_A	Operating Temperature Range		-40	+85	$^\circ\text{C}$	
Θ_{JA}	Thermal Resistance, Junction-to-Ambient			85 ⁽⁵⁾ 110 ⁽⁶⁾	$^\circ\text{C/W}$	
ESD	Electrostatic Discharge Capability	Human Body Model, JESD22-A114	8.0		kV	
		Charged Device Model, JESD22-C101	1.5			
		IEC61000-4-2 System Level	Air Discharge (V_{IN} , V_{ON} , V_{OUT} to GND)	15.0		
			Contact Discharge (V_{IN} , V_{ON} , V_{OUT} to GND)	8.0		

Notes:

5. Measured using 2S2P JEDEC std. PCB.
6. Measured using 2S2P JEDEC PCB cold plate method.

Recommended Operating Conditions

The Recommended Operating Conditions table defines the conditions for actual device operation. Recommended operating conditions are specified to ensure optimal performance to the datasheet specifications. Fairchild does not recommend exceeding them or designing to Absolute Maximum Ratings.

Symbol	Parameters	Min.	Typ.	Max.	Unit
V_{IN}	Input Voltage	1.5		5.5	V
T_A	Ambient Operating Temperature	-40		+85	$^\circ\text{C}$
I_{SW}	Continuous Switch Current		2.5	3	A

Electrical Characteristics

Unless otherwise noted, $V_{IN}=1.5$ to 5.5 V, $T_A=-40$ to $+85^\circ\text{C}$; typical values are at $V_{IN}=4.5$ V and $T_A=25^\circ\text{C}$.

Symbol	Parameters	Conditions	Min.	Typ.	Max.	Units
Basic Operation						
V_{IN}	Input Voltage		1.5		5.5	V
$I_{Q(OFF)}$	Off Supply Current	$V_{ON}=GND$, $V_{OUT}=Open$			1	μA
I_{SD}	Shutdown Current	$V_{ON}=GND$, $V_{OUT}=GND$, $T_A=-40$ to $+85^\circ\text{C}$		0.2	4.0	μA
I_Q	Quiescent Current	$I_{OUT}=0$ mA			11	μA
R_{ON}	On Resistance	$V_{IN}=5.5$ V, $I_{OUT}=3$ A ⁽⁷⁾		22.0		m Ω
		$V_{IN}=5.5$ V, $I_{OUT}=2$ A ⁽⁷⁾		21.5		
		$V_{IN}=5.5$ V, $I_{OUT}=1$ A, $T_A=25^\circ\text{C}$		21.0	28.0	
		$V_{IN}=4.5$ V, $I_{OUT}=3$ A ⁽⁷⁾		24.0		
		$V_{IN}=4.5$ V, $I_{OUT}=2$ A ⁽⁷⁾		23.5		
		$V_{IN}=4.5$ V, $I_{OUT}=1$ A, $T_A=25^\circ\text{C}$		23.0	30.0	
		$V_{IN}=3.3$ V, $I_{OUT}=500$ mA, $T_A=25^\circ\text{C}$		26.0		
		$V_{IN}=2.5$ V, $I_{OUT}=500$ mA, $T_A=25^\circ\text{C}$		30.0		
		$V_{IN}=1.8$ V, $I_{OUT}=250$ mA, $T_A=25^\circ\text{C}$		41.0		
		$V_{IN}=1.5$ V, $I_{OUT}=250$ mA, $T_A=25^\circ\text{C}$		90.0	110.0	
V_{IH}	ON Input Logic High Voltage	$V_{IN}=1.5$ V to 5.5 V	1.15			V
V_{IL}	ON Input Logic Low Voltage	$V_{IN}=1.8$ V to 5.5 V			0.65	V
		$V_{IN}=1.5$ V to 1.8 V			0.60	V
I_{ON}	ON Input Leakage	$V_{ON}=V_{IN}$ or GND			1.0	μA
R_{ON_PD}	Pull-Down Resistance at ON Pin	$V_{IN}=V_{ON}=1.5$ V to 5.5 V, $T_A=-40$ - $+85^\circ\text{C}$	6.38	7.65	8.86	M Ω
True Reverse Current Blocking						
V_{T_RCB}	RCB Protection Trip Point	$V_{OUT} - V_{IN}$		45		mV
V_{R_RCB}	RCB Protection Release Trip Point	$V_{IN} - V_{OUT}$		25		mV
	RCB Hysteresis			70		mV
I_{SD_OUT}	V_{OUT} Shutdown Current	$V_{ON}=0$, $V_{OUT}=4.5$ V, V_{IN} = Short to GND			2	μA
t_{RCB_ON}	RCB Response Time, Device ON	$V_{OUT} - V_{IN}=100$ mV, $V_{ON}=HIGH$		4		μs
t_{RCB_OFF}	RCB Response Time, Device OFF	$V_{OUT} - V_{IN}=100$ mV, $V_{ON}=LOW$		2.5		μs
Dynamic Characteristics						
t_{DON}	Turn-On Delay ^(8,9)	$V_{IN}=4.5$ V, $R_L=5$ Ω , $C_L=100$ μF , $T_A=25^\circ\text{C}$		1.7		ms
t_R	V_{OUT} Rise Time ^(8,9)			2.7		ms
t_{ON}	Turn-On Time ^(8,9)			4.4		ms
t_{DON}	Turn-On Delay ^(8,9)	$V_{IN}=4.5$ V, $R_L=150$ Ω , $C_L=100$ μF , $T_A=25^\circ\text{C}$		1.7		ms
t_R	V_{OUT} Rise Time ^(8,9)			1.5		ms
t_{ON}	Turn-On Time ^(8,9)			3.2		ms
t_{DOFF}	Turn-Off Delay ^(8,10)	$V_{IN}=4.5$ V, $R_L=150$ Ω , $C_L=100$ μF , $T_A=25^\circ\text{C}$		1.8		ms
t_F	V_{OUT} Fall Time ^(8,10)			34		ms
t_{OFF}	Turn-Off Time ^(8,10)			35		ms

Notes:

- This parameter is guaranteed by design and characterization; not production tested.
- $t_{DON}/t_{DOFF}/t_R/t_F$ are defined in Figure 22.
- $t_{ON}=t_R + t_{DON}$.
- $t_{OFF}=t_F + t_{DOFF}$.

Typical Characteristics

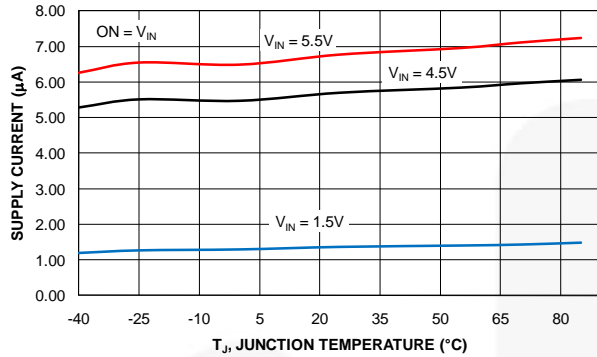

Figure 6. Supply Current vs. Temperature

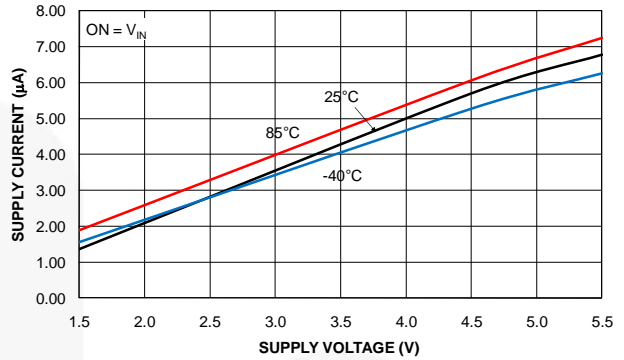

Figure 7. Supply Current vs. Supply Voltage

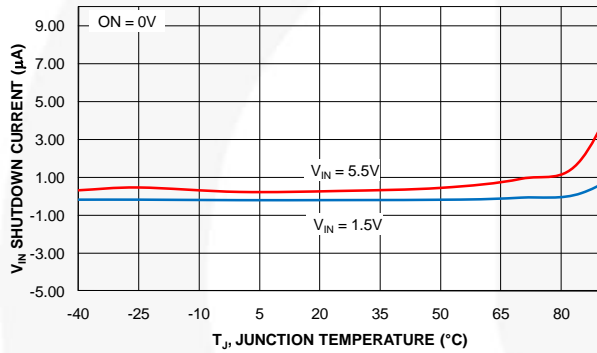

Figure 8. Shutdown Current vs. Temperature

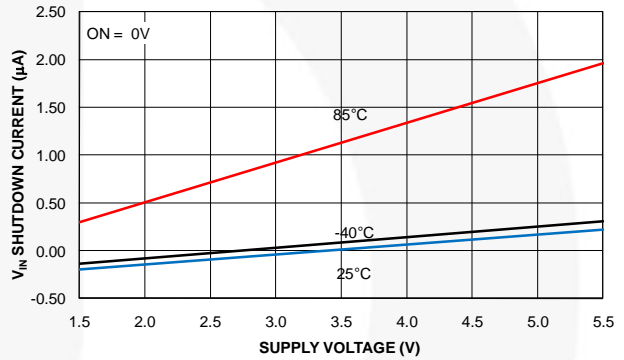

Figure 9. Shutdown Current vs. Supply Voltage

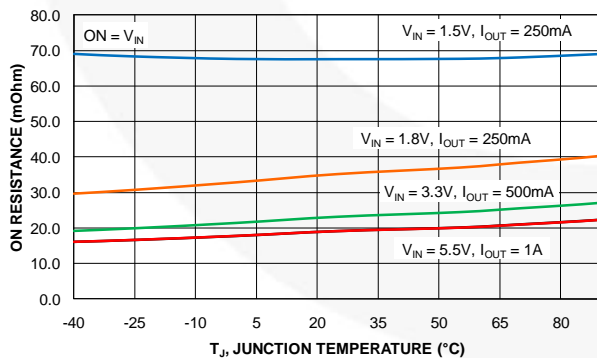

Figure 10. R_{ON} vs. Temperature

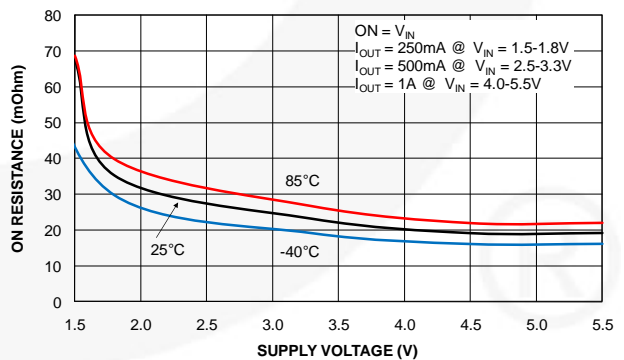

Figure 11. R_{ON} vs. Supply Voltage

Typical Characteristics

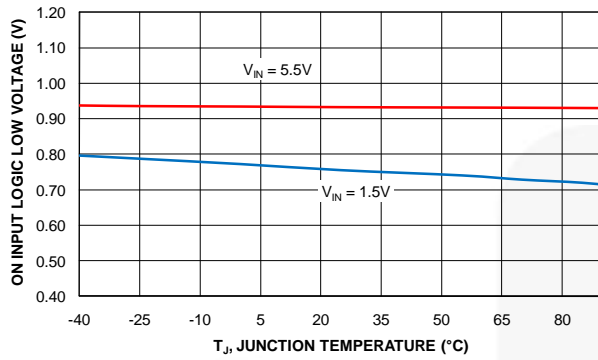

Figure 12. V_{IL} vs. Temperature

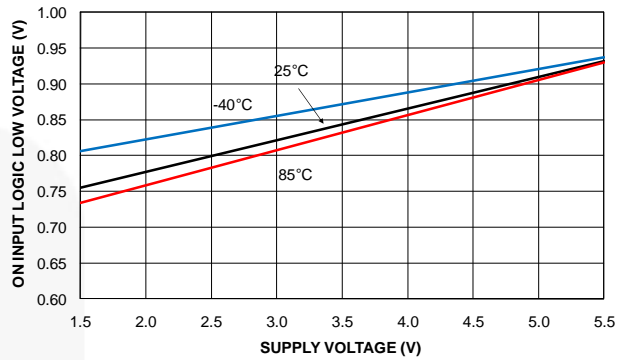

Figure 13. V_{IL} vs. Supply Voltage

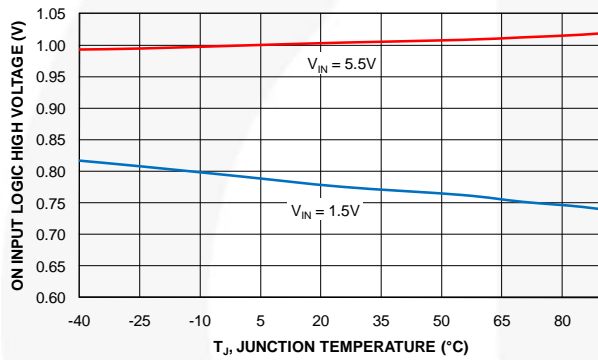

Figure 14. V_{IH} vs. Temperature

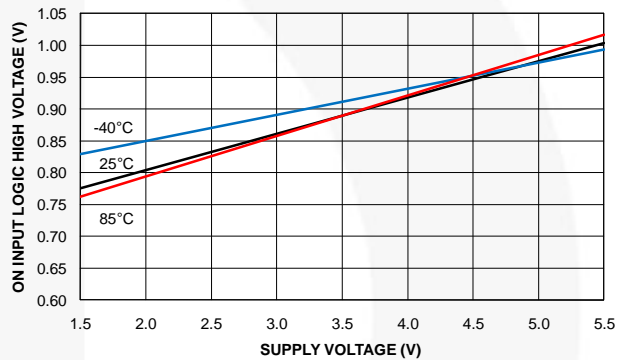

Figure 15. V_{IH} vs. Supply Voltage

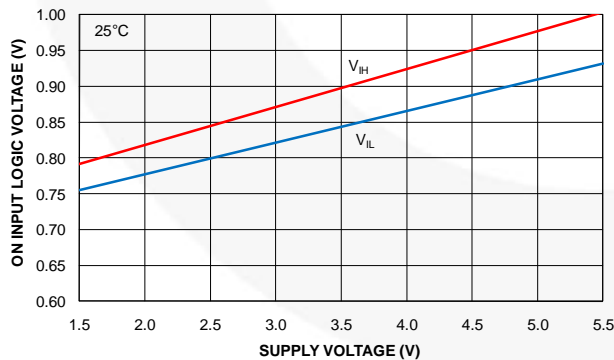

Figure 16. On Pin Threshold vs. Supply Voltage

Typical Characteristics

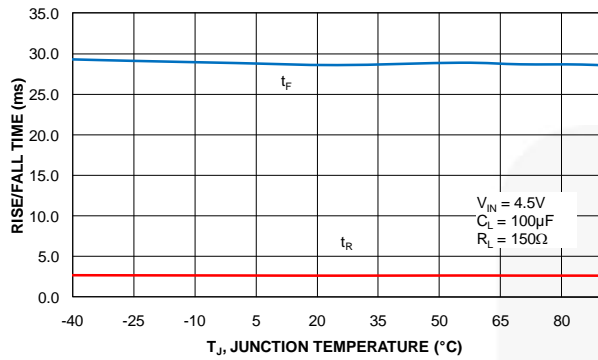

Figure 17. t_R / t_F vs. Temperature

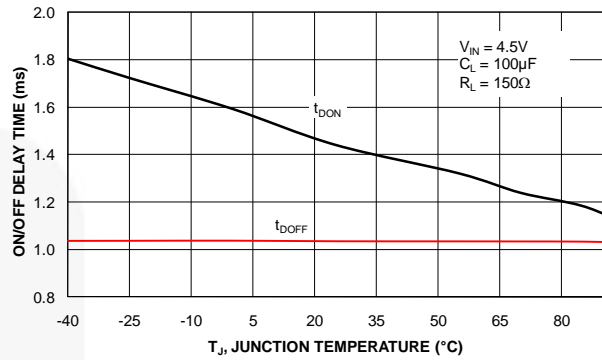

Figure 18. t_{DON} vs. Temperature

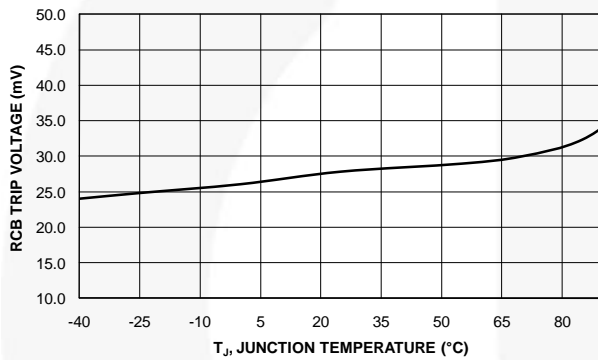

Figure 19. RCB Trip vs. Temperature

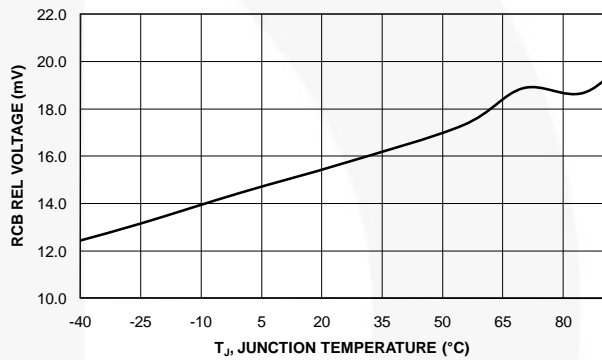

Figure 20. RCB Release vs. Temperature

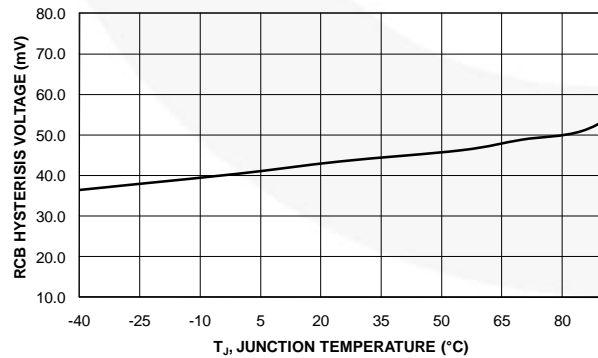

Figure 21. RCB Hysteresis vs. Temperature

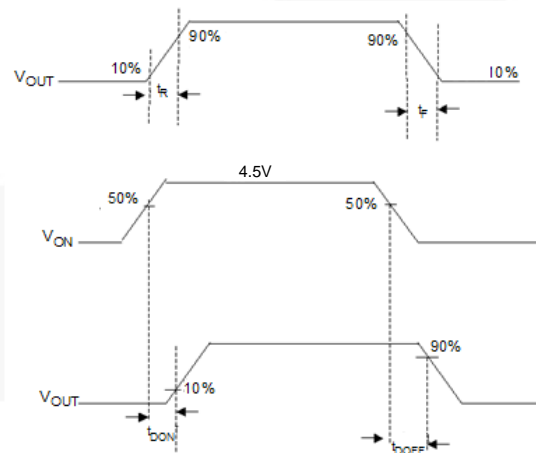

Figure 22. Timing Diagram

Typical Characteristics

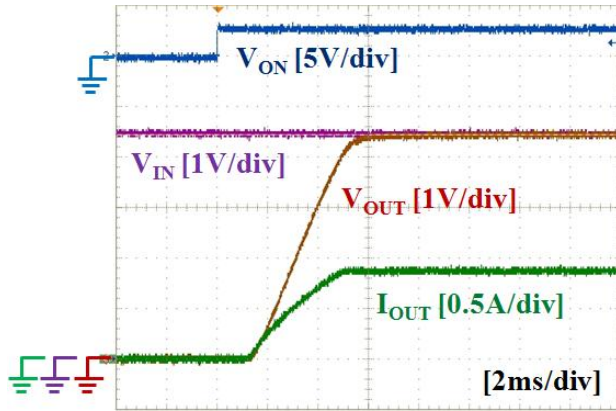

Figure 23. Turn-On Response
($V_{IN}=4.5\text{ V}$, $C_{IN}=10\text{ }\mu\text{F}$, $C_{OUT}=100\text{ }\mu\text{F}$, $R_L=5\text{ }\Omega$)

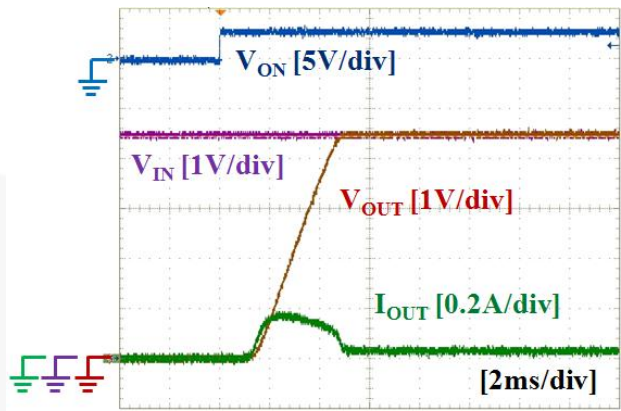

Figure 24. Turn-On Response
($V_{IN}=4.5\text{ V}$, $C_{IN}=10\text{ }\mu\text{F}$, $C_{OUT}=100\text{ }\mu\text{F}$, $R_L=150\text{ }\Omega$)

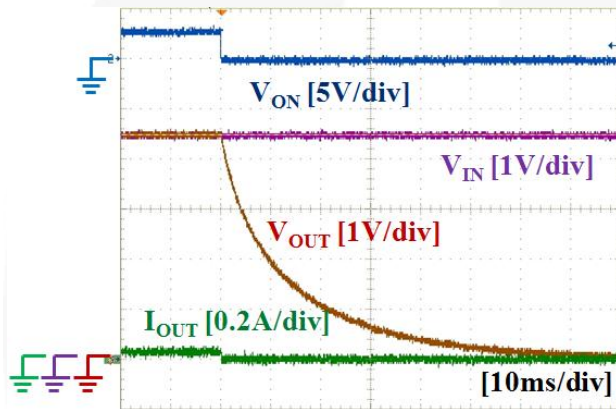

Figure 25. Turn-Off Response
($V_{IN}=4.5\text{ V}$, $C_{IN}=10\text{ }\mu\text{F}$, $C_{OUT}=100\text{ }\mu\text{F}$, $R_L=150\text{ }\Omega$)

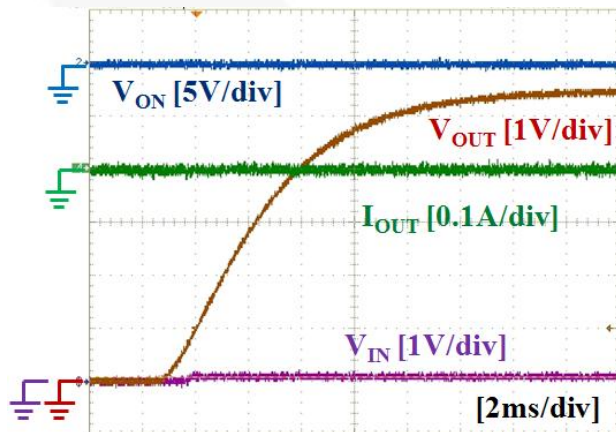

Figure 26. RCB Response During Off ($V_{IN}=\text{Open}$, $V_{ON}=\text{GND}$, $V_{OUT}=5.5\text{ V}$, $C_{IN}=10\text{ }\mu\text{F}$, $C_{OUT}=100\text{ }\mu\text{F}$)

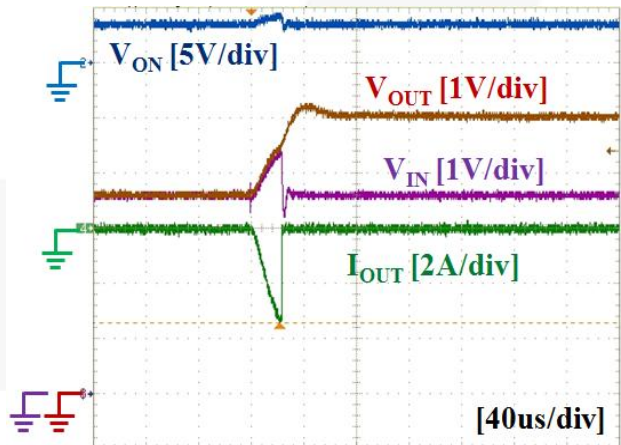

Figure 27. RCB Response During On ($V_{IN}=V_{ON}=3.6\text{ V}$, $V_{OUT}=5\text{ V}$, $C_{IN}=10\text{ }\mu\text{F}$, $C_{OUT}=100\text{ }\mu\text{F}$)

Operation and Application Description

The FPF1048 is a low- R_{ON} P-channel load switch with controlled turn-on and True Reverse Current Blocking (TRCB). The core is a 23 m Ω P-channel MOSFET and controller capable of functioning over a wide input operating range of 1.5 to 5.5 V. The ON pin, an active-HIGH, GPIO/CMOS-compatible input; controls the state of the switch. TRCB functionality blocks unwanted reverse current during both ON and OFF states when higher V_{OUT} than V_{IN} is applied.

Input Capacitor

To limit the voltage drop on the input supply caused by transient inrush current when the switch turns on into a discharged load capacitor; a capacitor must be placed between the V_{IN} and GND pins. At least 1 μF ceramic capacitor, C_{IN} , placed close to the pins is usually sufficient. Higher-value C_{IN} can be used to reduce the voltage drop in higher-current applications.

Inrush Current

Inrush current occurs when the device is turned on. Inrush current is dependent on output capacitance and slew rate control capability, as expressed by:

$$I_{INRUSH} = C_{OUT} \times \frac{V_{IN} - V_{INITIAL}}{t_R} + I_{LOAD} \quad (1)$$

where:

- C_{OUT} : Output capacitance;
- t_R : Slew rate or rise time at V_{OUT} ;
- V_{IN} : Input voltage;
- $V_{INITIAL}$: Initial voltage at C_{OUT} , usually GND; and
- I_{LOAD} : Load current.

Higher inrush current causes higher input voltage drop, depending on the distributed input resistance and input capacitance. High inrush current can cause problems.

FPF1048 has a 2.7 ms of slew rate capability under 4.5 V_{IN} at 1000 μF of C_{OUT} and 5 Ω of R_L so inrush current can be minimized and no input voltage drop appears. Table 1 and Figure 28 show the values and actual waveforms with $C_{IN}=10 \mu\text{F}$, $C_{OUT}=100 \mu\text{F}$, and no load current.

Table 1. Inrush Current by Input Voltage

V_{IN} [V]	t_R [ms]	Inrush Current [mA]	
		Measured	Calculated with 2.7 ms t_R
1.5	1.62	76	56
3.3	2.03	140	122
5.0	2.33	196	185

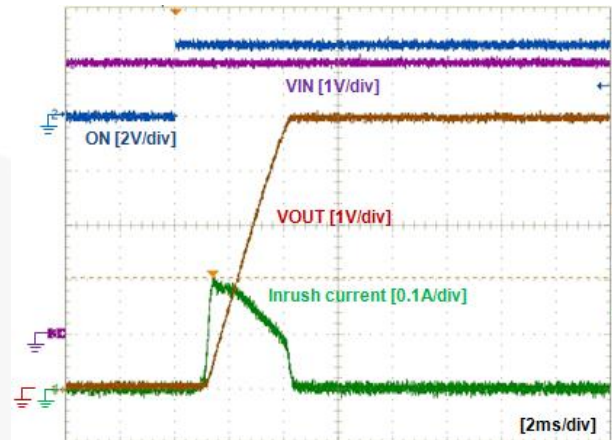

Figure 28. Inrush Current Waveform, Under 5 V_{IN} , $C_{OUT}=100 \mu\text{F}$, no Load

Output Capacitor

At least 0.1 μF capacitor, C_{OUT} , should be placed between the V_{OUT} and GND pins. This capacitor prevents parasitic board inductance from forcing V_{OUT} below GND when the switch is on.

True Reverse Current Blocking

The true reverse current blocking feature protects the input source against current flow from output to input regardless of whether the load switch is on or off.

Board Layout

For best performance, all traces should be as short as possible. To be most effective, the input and output capacitors should be placed close to the device to minimize the effect that parasitic trace inductance on normal and short-circuit operation. Using wide traces or large copper planes for all pins (V_{IN} , V_{OUT} , ON, and GND) minimizes the parasitic electrical effects and the case-to-ambient thermal impedance.

Physical Dimensions

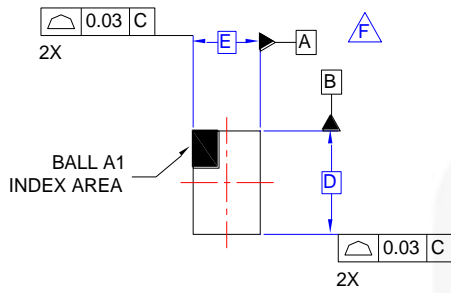

TOP VIEW

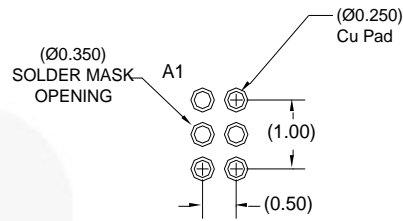

RECOMMENDED LAND PATTERN
(NSMD PAD TYPE)

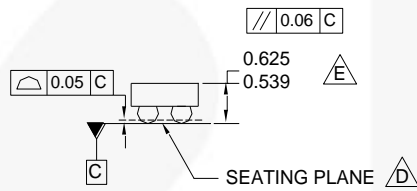

SIDE VIEWS

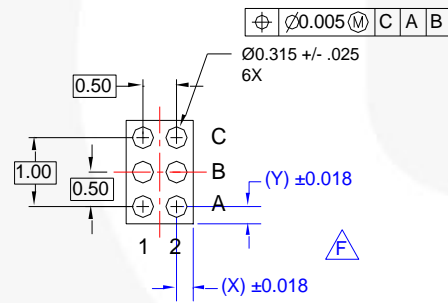

BOTTOM VIEW

NOTES:

- A. NO JEDEC REGISTRATION APPLIES.
- B. DIMENSIONS ARE IN MILLIMETERS.
- C. DIMENSIONS AND TOLERANCE PER ASMEY14.5M, 1994.
- D. DATUM C IS DEFINED BY THE SPHERICAL CROWNS OF THE BALLS.
- E. PACKAGE NOMINAL HEIGHT IS 582 MICRONS ±43 MICRONS (539-625 MICRONS).
- F. FOR DIMENSIONS D, E, X, AND Y SEE PRODUCT DATASHEET.
- G. DRAWING FILNAME: MKT-UC006AFrev2.

Figure 29. 6-Ball WLCSP, 2x3 Array, 0.5 mm Pitch, 300 µm Ball

Product-Specific Dimensions

Product	D	E	X	Y
FPF1048BUCX	1460 µm ±30 µm	960 µm ±30 µm	230 µm	230 µm

ON Semiconductor and  are trademarks of Semiconductor Components Industries, LLC dba ON Semiconductor or its subsidiaries in the United States and/or other countries. ON Semiconductor owns the rights to a number of patents, trademarks, copyrights, trade secrets, and other intellectual property. A listing of ON Semiconductor's product/patent coverage may be accessed at www.onsemi.com/site/pdf/Patent-Marking.pdf. ON Semiconductor reserves the right to make changes without further notice to any products herein. ON Semiconductor makes no warranty, representation or guarantee regarding the suitability of its products for any particular purpose, nor does ON Semiconductor assume any liability arising out of the application or use of any product or circuit, and specifically disclaims any and all liability, including without limitation special, consequential or incidental damages. Buyer is responsible for its products and applications using ON Semiconductor products, including compliance with all laws, regulations and safety requirements or standards, regardless of any support or applications information provided by ON Semiconductor. "Typical" parameters which may be provided in ON Semiconductor data sheets and/or specifications can and do vary in different applications and actual performance may vary over time. All operating parameters, including "Typicals" must be validated for each customer application by customer's technical experts. ON Semiconductor does not convey any license under its patent rights nor the rights of others. ON Semiconductor products are not designed, intended, or authorized for use as a critical component in life support systems or any FDA Class 3 medical devices or medical devices with a same or similar classification in a foreign jurisdiction or any devices intended for implantation in the human body. Should Buyer purchase or use ON Semiconductor products for any such unintended or unauthorized application, Buyer shall indemnify and hold ON Semiconductor and its officers, employees, subsidiaries, affiliates, and distributors harmless against all claims, costs, damages, and expenses, and reasonable attorney fees arising out of, directly or indirectly, any claim of personal injury or death associated with such unintended or unauthorized use, even if such claim alleges that ON Semiconductor was negligent regarding the design or manufacture of the part. ON Semiconductor is an Equal Opportunity/Affirmative Action Employer. This literature is subject to all applicable copyright laws and is not for resale in any manner.

PUBLICATION ORDERING INFORMATION

LITERATURE FULFILLMENT:

Literature Distribution Center for ON Semiconductor
19521 E. 32nd Pkwy, Aurora, Colorado 80011 USA
Phone: 303-675-2175 or 800-344-3860 Toll Free USA/Canada
Fax: 303-675-2176 or 800-344-3867 Toll Free USA/Canada
Email: orderlit@onsemi.com

N. American Technical Support: 800-282-9855 Toll Free
USA/Canada
Europe, Middle East and Africa Technical Support:
Phone: 421 33 790 2910
Japan Customer Focus Center
Phone: 81-3-5817-1050

ON Semiconductor Website: www.onsemi.com
Order Literature: <http://www.onsemi.com/orderlit>
For additional information, please contact your local
Sales Representative