

Test Procedure for the LV8736VGEVB Evaluation Board

For Stepper Motor Control

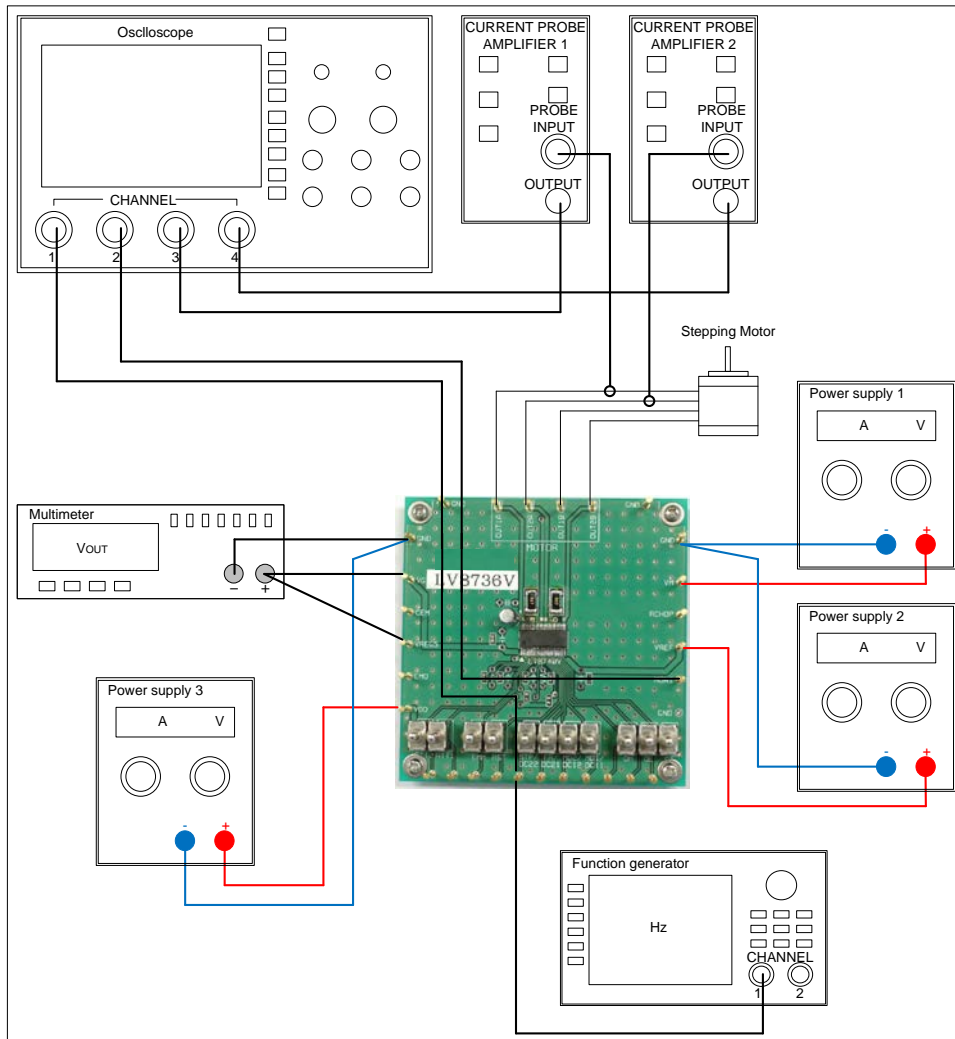

Table1: Required Equipment

Equipment	Efficiency
Power supply1	35V-5A
Power supply2	5V-0.5A
Power supply3	10V-1A
Function generator	200kHz
Multimeter	-
Oscilloscope	4 channel
Current probe1	-
Current probe2	-
LV8736V Evaluation Board	-
Stepper Motor	35V-3A



Test Procedure:

1. Connect the test setup as shown above.
2. Set it according to the following specifications.

Supply Voltage

- VM (9 to 32V): Power Supply for LSI
- VREF (0 to 3V): Const. Current Control for Reference Voltage
- VDD (2 to 5V): Logic “High” voltage for toggle switch

Toggle Switch State

- Upper Side: High (VDD)
- Middle: Open, enable to external logic input
- Lower Side: Low (GND)

Operations Guide

1. **Initial Condition Setting:** Set “Open” the toggle switch STEP/D22, and “Open or Low” the other switches.
 2. **Power Supply:** Supply DC voltage to VM, VREF and VDD.
 3. **Ready for Operation from Standby State:** Turn “High” the ST terminal toggle switch. Channel 1 and 2 are into 2-phase excitement initial position (100%, -100%) .
 4. **Motor Operation:** Input the clock signal into the terminal STEP/DC22.
 5. **Other Setting:** (See Application Note for detail)
 - i. ATT1, ATT2: Motor current attenuation.
 - ii. EMM: Short circuit protection mode change.
 - iii. RST/BLK: Initial Mode.
 - iv. FR/DC21: Motor rotation direction (CW/CCW) setting.
 - v. MD1/DC11, MD2/DC12: Excitation mode.
 - vi. OE/CMK: Output Enable.
3. Check VREG5 and VG terminal voltage at multimeter.
 4. Check the STEP/DC22 and MONI terminal voltage at scope CH1 and CH2, and the output current waveform at scope CH3 and CH4.

Table2: Desired Results

INPUT	OUTPUT
VM=24V VREF=1.5V VDD=5V ST=High DM=Low EMM=Low, RST/BLK=Low, OE/CMK=Low ATT1=ATT2=Low FR/DC21=Low MD1/DC11=MD2/DC12=High STEP/DC22=500Hz(Duty50%)	VREG5=4.5V to 5.5V VG=28V to 29.8V

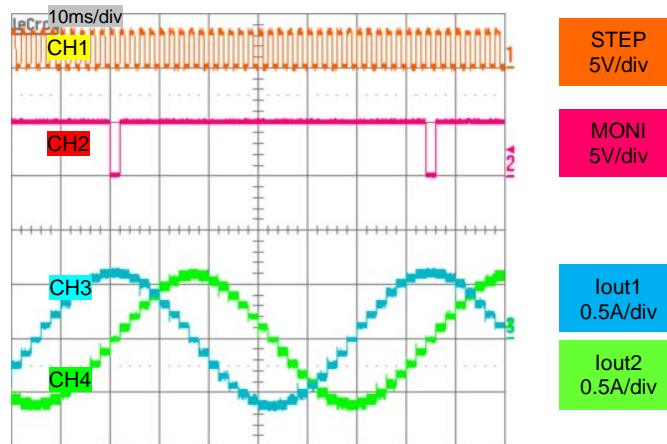

For DC Motor Control

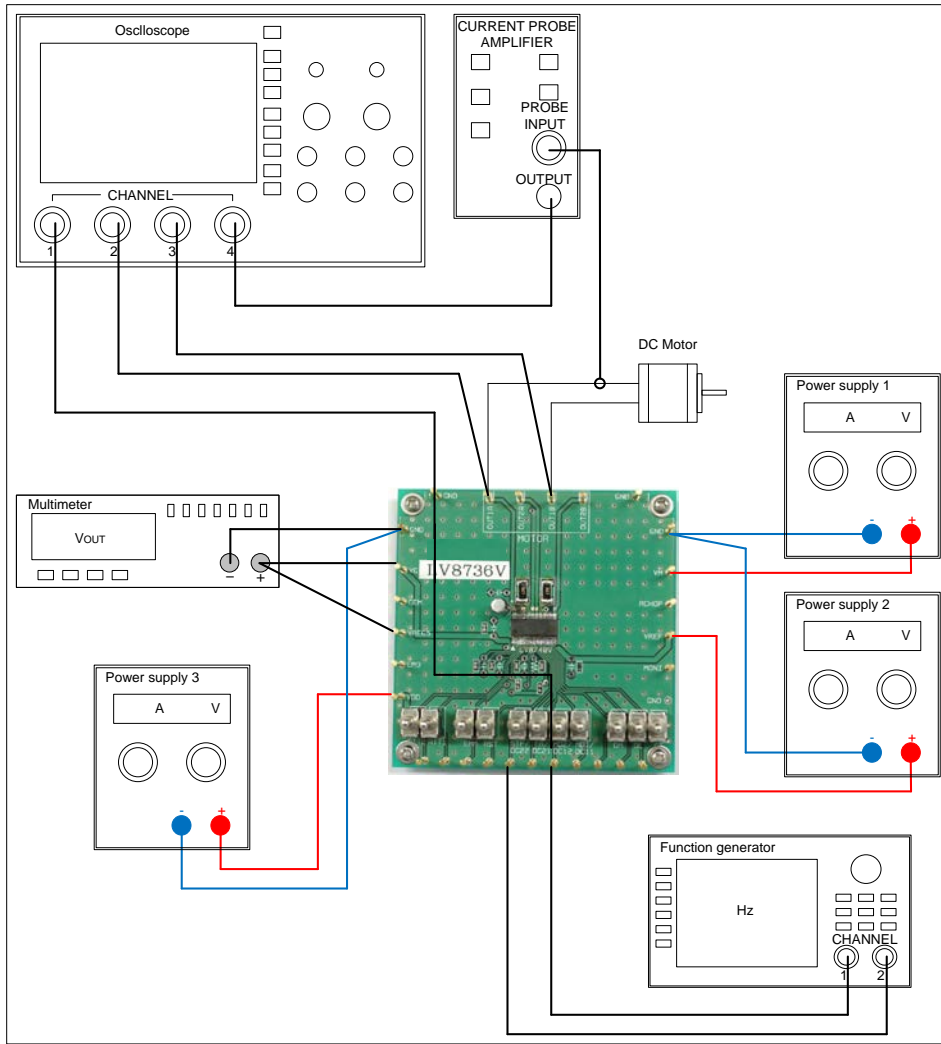

Table3: Required Equipment

Equipment	Efficiency
Power supply1	35V-5A
Power supply2	5V-0.5A
Power supply3	10V-1A
Function generator	200kHz
Multimeter	-
Oscilloscope	4 channel
Current probe	-
LV8736V Evaluation Board	-
DC Motor	35V-3A



Test Procedure:

1. Connect the test setup as shown above.
2. Set it according to the following specifications.

Supply Voltage

- VM (9 to 32V): Power Supply for LSI
- VREF (0 to 3V): Const. Current Control for Reference Voltage
- VDD (2 to 5V): Logic “High” voltage for toggle switch

Toggle Switch State

- Upper Side: High (VDD)
- Middle: Open, enable to external logic input
- Lower Side: Low (GND)

Operations Guide

1. **Initial Condition Setting:** Set “Open” the toggle switch DM, and “Open or Low” the other switches.
 2. **Power Supply:** Supply DC voltage to VM, VREF and VDD.
 3. **Ready for Operation from Standby State:** Turn “High” the ST terminal toggle switch.
 4. **Motor Operation:** Set MD1/DC11, MD2/DC12, FR/DC21, and STEP/DC22 terminals according to the purpose.
 5. **Other Setting:** (See Application Note for detail)
 - i. ATT1, ATT2: Motor current attenuation.
 - ii. EMM: Short circuit protection mode change.
 - iii. RST/BLK: Blanking time change.
3. Check VREG5 and VG terminal voltage at multimeter.
 4. Check the MD2/DC12, OUT1A, and OUT1B terminal voltage at scope CH1, CH2, and CH3, and the output current waveform at scope CH4.
 5. Switch to channel 2(STEP/DC22, OUT2A, OUT2B) as well as channel 1(MD2/DC12, OUT1A, OUT1B) and measure it.

Table4: Desired Results

INPUT	OUTPUT
VM=24V VREF=1.5V VDD=5V ST=High DM=High EMM=Low, RST/BLK=Low, OE/CMK=Open ATT1=ATT2=Low FR/DC21=STEP/DC22=Low MD1/DC11=High MD2/DC12=100kHz(Duty50%)	VREG5=4.5V to 5.5V VG=28V to 29.8V

