

Switch-mode Power Rectifier 100 V, 60 A

MBR60H100CTG, MBRB60H100CTT4G, NRVBB60H100CTT4G

Features and Benefits

- Low Forward Voltage: 0.72 V @ 125°C
- Low Power Loss/High Efficiency
- High Surge Capacity
- 175°C Operating Junction Temperature
- 60 A Total (30 A Per Diode Leg)
- NRVB Prefix for Automotive and Other Applications Requiring Unique Site and Control Change Requirements; AEC-Q101 Qualified and PPAP Capable
- These Devices are Pb-Free and are RoHS Compliant

Applications

- Power Supply – Output Rectification
- Power Management
- Instrumentation

Mechanical Characteristics:

- Case: Epoxy, Molded
- Epoxy Meets UL 94 V-0 @ 0.125 in
- Weight (Approximately): 1.9 Grams (TO-220)
1.7 Grams (D²PAK-3)
- Finish: All External Surfaces Corrosion Resistant and Terminal Leads are Readily Solderable
- Lead Temperature for Soldering Purposes: 260°C Max. for 10 Seconds
- ESD Rating: Human Body Model = 3B
Machine Model = C

SCHOTTKY BARRIER RECTIFIER 60 AMPERES, 100 VOLTS

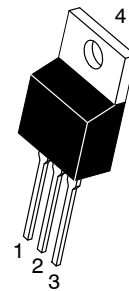
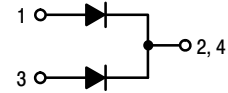

TO-220
CASE 221A
STYLE 6

MARKING DIAGRAM

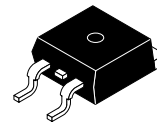
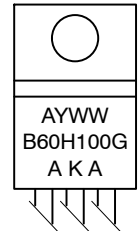

D²PAK-3
CASE 418B
STYLE 3

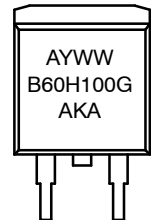

A = Assembly Location
Y = Year
WW = Work Week
B60H100 = Device Code
G = Pb-Free Package
AKA = Polarity Designator

ORDERING INFORMATION

| Device | Package | Shipping [†] |
|------------------|--------------------------------|-----------------------|
| MBR60H100CTG | TO-220 (Pb-Free) | 50 Units/Rail |
| NRVBB60H100CTT4G | D ² PAK-3 (Pb-Free) | 800/ Tape & Reel |

DISCONTINUED (Note 1)

| | | |
|-----------------|--------------------------------|---------------------|
| MBRB60H100CTT4G | D ² PAK-3 (Pb-Free) | 800/ Tape & Reel |
|-----------------|--------------------------------|---------------------|

[†]For information on tape and reel specifications, including part orientation and tape sizes, please refer to our Tape and Reel Packaging Specifications Brochure, BRD8011/D.

1. **DISCONTINUED:** This device is not recommended for new design. Please contact your onsemi representative for information. The most current information on this device may be available on www.onsemi.com.

MBR60H100CTG, MBRB60H100CTT4G, NRVBB60H100CTT4G

MAXIMUM RATINGS (Per Diode Leg)

| Rating | Symbol | Value | Unit |
|--|---------------------------------|-----------------|------------------------|
| Peak Repetitive Reverse Voltage Working Peak Reverse Voltage DC Blocking Voltage | V_{RRM} V_{RWM} V_R | 100 | V |
| Average Rectified Forward Current ($T_C = 155^\circ\text{C}$) Per Diode Per Device | $I_{F(AV)}$ | 30 60 | A |
| Peak Repetitive Forward Current (Square Wave, 20 kHz, $T_C = 151^\circ\text{C}$) | I_{FRM} | 60 | A |
| Nonrepetitive Peak Surge Current (Surge applied at rated load conditions halfwave, single phase, 60 Hz) | I_{FSM} | 350 | A |
| Operating Junction Temperature Range (Note 1) | T_J | -55 to +175 | $^\circ\text{C}$ |
| Storage Temperature Range | T_{stg} | -65 to +175 | $^\circ\text{C}$ |
| Voltage Rate of Change (Rated V_R) | dV/dt | 10,000 | $\text{V}/\mu\text{s}$ |
| Controlled Avalanche Energy (see test conditions in Figures 9 and 10) | W_{AVAL} | 400 | mJ |
| ESD Ratings: Machine Model = C Human Body Model = 3B | | > 400 > 8000 | V |

Stresses exceeding those listed in the Maximum Ratings table may damage the device. If any of these limits are exceeded, device functionality should not be assumed, damage may occur and reliability may be affected.

1. The heat generated must be less than the thermal conductivity from Junction-to-Ambient: $dP_D/dT_J < 1/R_{\theta JA}$.

THERMAL CHARACTERISTICS

| Characteristic | Symbol | Value | Unit |
|---|------------------------------------|-----------|---------------------------|
| Maximum Thermal Resistance Junction-to-Case (Min. Pad) Junction-to-Ambient (Min. Pad) | $R_{\theta JC}$ $R_{\theta JA}$ | 1.0 70 | $^\circ\text{C}/\text{W}$ |

ELECTRICAL CHARACTERISTICS (Per Diode Leg)

| Characteristic | Symbol | Min | Typ | Max | Unit |
|--|--------|-----|------------------------------|------------------------------|------|
| Maximum Instantaneous Forward Voltage (Note 2) ($i_F = 30\text{ A}$, $T_J = 25^\circ\text{C}$) ($i_F = 30\text{ A}$, $T_J = 125^\circ\text{C}$) ($i_F = 60\text{ A}$, $T_J = 25^\circ\text{C}$) ($i_F = 60\text{ A}$, $T_J = 125^\circ\text{C}$) | v_F | - | 0.80 0.68 0.93 0.81 | 0.84 0.72 0.98 0.84 | V |
| Maximum Instantaneous Reverse Current (Note 2) (Rated DC Voltage, $T_J = 125^\circ\text{C}$) (Rated DC Voltage, $T_J = 25^\circ\text{C}$) | i_R | - | 2.0 0.0013 | 10 0.01 | mA |

Product parametric performance is indicated in the Electrical Characteristics for the listed test conditions, unless otherwise noted. Product performance may not be indicated by the Electrical Characteristics if operated under different conditions.

2. Pulse Test: Pulse Width = 300 μs , Duty Cycle $\leq 2.0\%$.

MBR60H100CTG, MBRB60H100CTT4G, NRVBB60H100CTT4G

TYPICAL CHARACTERISTICS

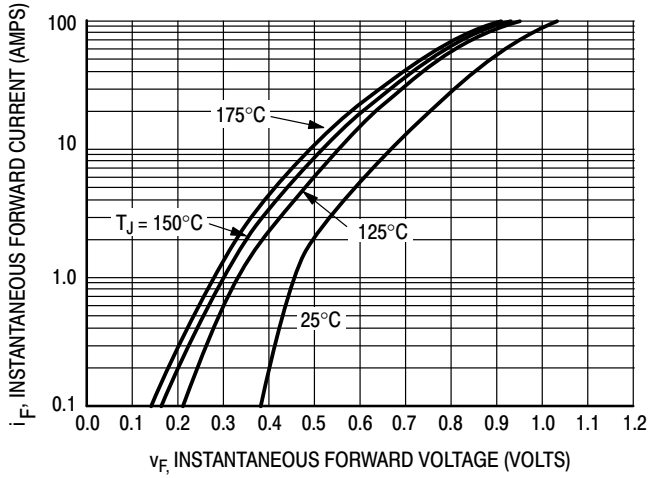

Figure 1. Typical Forward Voltage

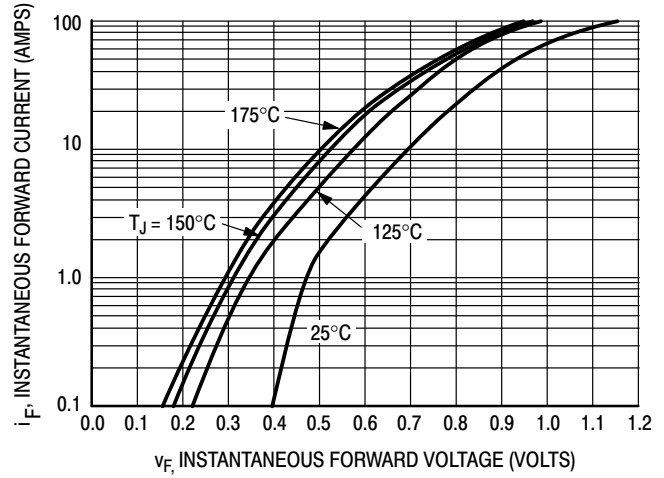

Figure 2. Maximum Forward Voltage

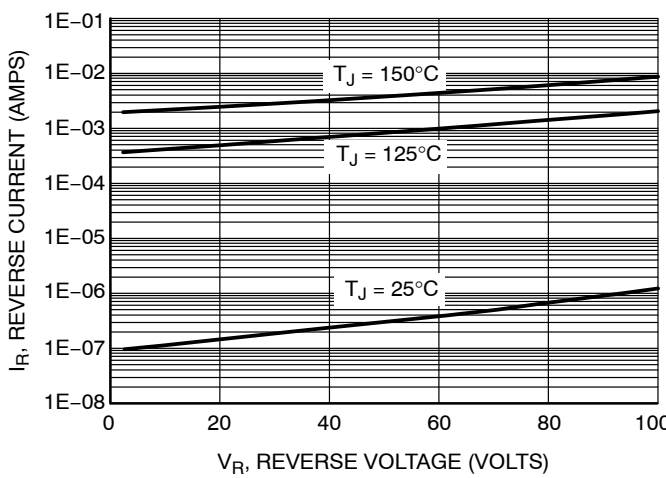

Figure 3. Typical Reverse Current

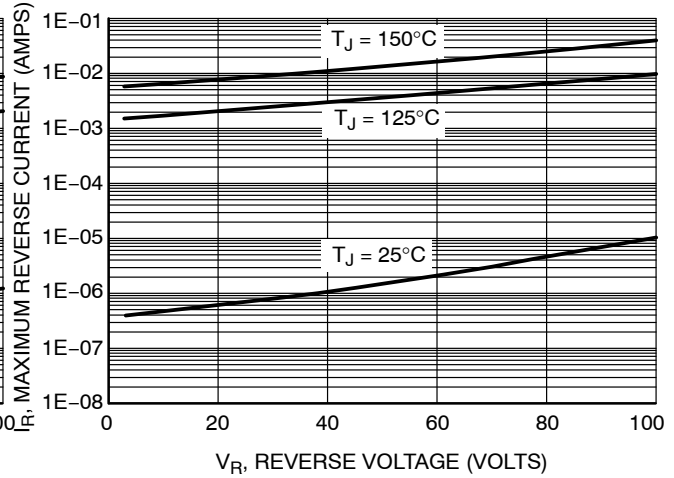

Figure 4. Maximum Reverse Current

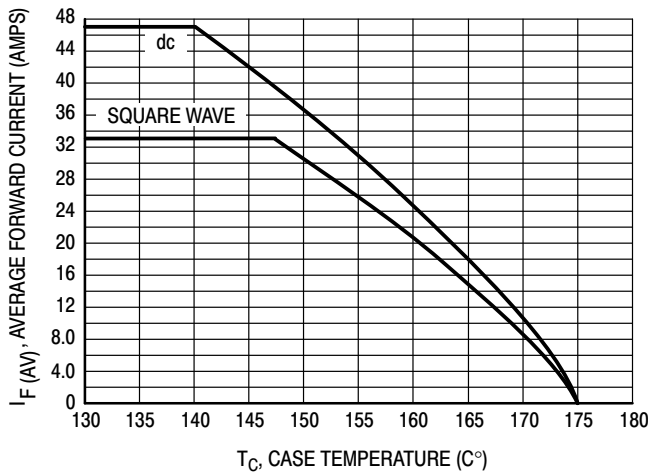

Figure 5. Current Derating, Case Per Leg

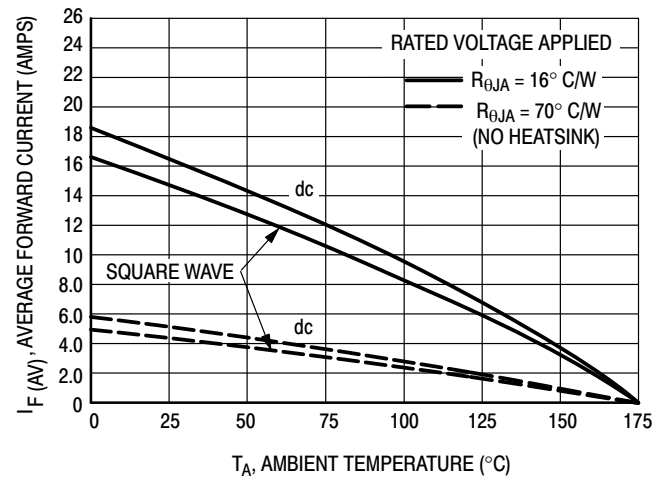

Figure 6. Current Derating, Ambient Per Leg

TYPICAL CHARACTERISTICS

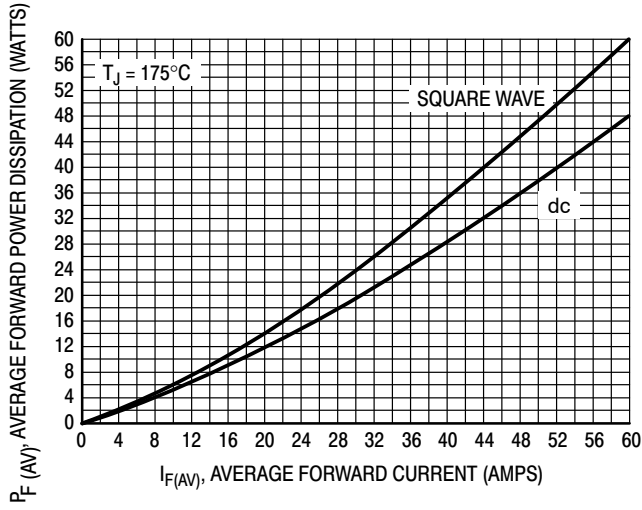

Figure 7. Forward Power Dissipation

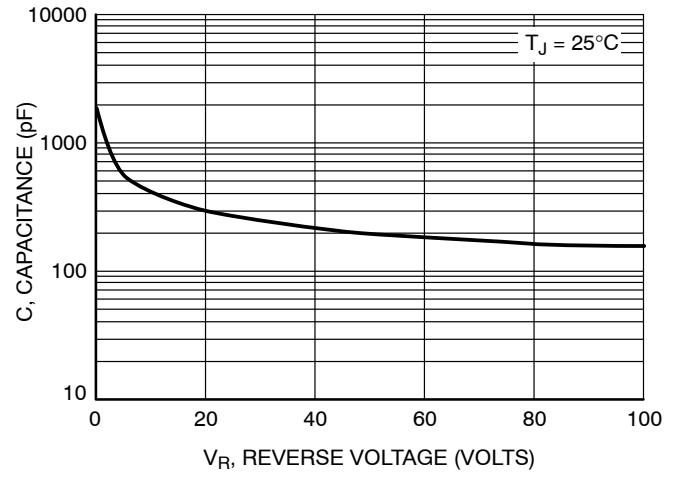

Figure 8. Capacitance

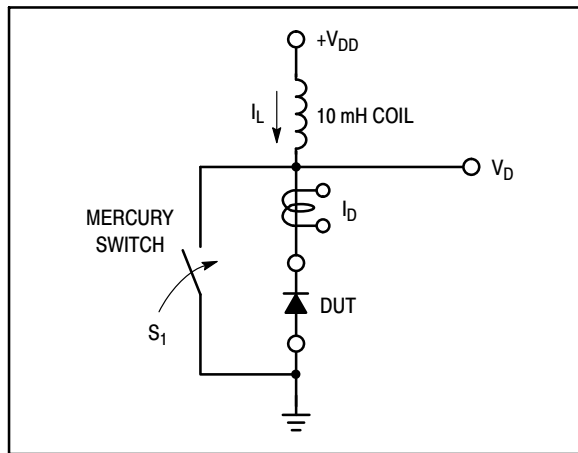

Figure 9. Test Circuit

The unclamped inductive switching circuit shown in Figure 9 was used to demonstrate the controlled avalanche capability of this device. A mercury switch was used instead of an electronic switch to simulate a noisy environment when the switch was being opened.

When S_1 is closed at t_0 the current in the inductor I_L ramps up linearly; and energy is stored in the coil. At t_1 the switch is opened and the voltage across the diode under test begins to rise rapidly, due to di/dt effects, when this induced voltage reaches the breakdown voltage of the diode, it is clamped at BV_{DUT} and the diode begins to conduct the full load current which now starts to decay linearly through the diode, and goes to zero at t_2 .

By solving the loop equation at the point in time when S_1 is opened; and calculating the energy that is transferred to the diode it can be shown that the total energy transferred is equal to the energy stored in the inductor plus a finite amount of energy from the V_{DD} power supply while the diode is in breakdown (from t_1 to t_2) minus any losses due to finite component resistances. Assuming the component resistive

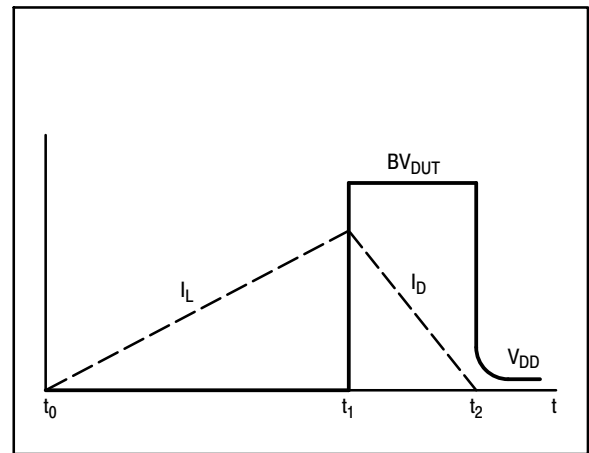

Figure 10. Current-Voltage Waveforms

elements are small Equation (1) approximates the total energy transferred to the diode. It can be seen from this equation that if the V_{DD} voltage is low compared to the breakdown voltage of the device, the amount of energy contributed by the supply during breakdown is small and the total energy can be assumed to be nearly equal to the energy stored in the coil during the time when S_1 was closed, Equation (2).

EQUATION (1):

$$W_{AVAL} \approx \frac{1}{2} L I_{LPK}^2 \left(\frac{BV_{DUT}}{BV_{DUT} - V_{DD}} \right)$$

EQUATION (2):

$$W_{AVAL} \approx \frac{1}{2} L I_{LPK}^2$$

TO-220
CASE 221A
ISSUE AK

DATE 13 JAN 2022

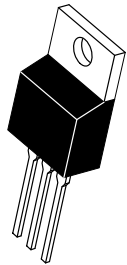

SCALE 1:1

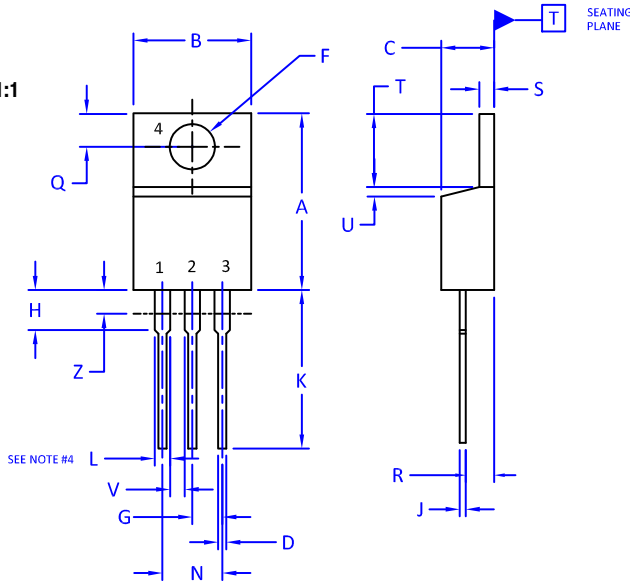

NOTES:

1. DIMENSIONING AND TOLERANCING PER ANSI Y14.5M, 2009.
2. CONTROLLING DIMENSION: INCHES
3. DIMENSION Z DEFINES A ZONE WHERE ALL BODY AND LEAD IRREGULARITIES ARE ALLOWED.
4. MAX WIDTH FOR F102 DEVICE = 1.35MM

| DIM | INCHES | | MILLIMETERS | |
|-----|--------|-------|-------------|-------|
| | MIN. | MAX. | MIN. | MAX. |
| A | 0.570 | 0.620 | 14.48 | 15.75 |
| B | 0.380 | 0.415 | 9.66 | 10.53 |
| C | 0.160 | 0.190 | 4.07 | 4.83 |
| D | 0.025 | 0.038 | 0.64 | 0.96 |
| F | 0.142 | 0.161 | 3.60 | 4.09 |
| G | 0.095 | 0.105 | 2.42 | 2.66 |
| H | 0.110 | 0.161 | 2.80 | 4.10 |
| J | 0.014 | 0.024 | 0.36 | 0.61 |
| K | 0.500 | 0.562 | 12.70 | 14.27 |
| L | 0.045 | 0.060 | 1.15 | 1.52 |
| N | 0.190 | 0.210 | 4.83 | 5.33 |
| Q | 0.100 | 0.120 | 2.54 | 3.04 |
| R | 0.080 | 0.110 | 2.04 | 2.79 |
| S | 0.045 | 0.055 | 1.15 | 1.41 |
| T | 0.235 | 0.255 | 5.97 | 6.47 |
| U | 0.000 | 0.050 | 0.00 | 1.27 |
| V | 0.045 | ---- | 1.15 | --- |
| Z | ---- | 0.080 | --- | 2.04 |

STYLE 1:

- PIN 1. BASE
- 2. COLLECTOR
- 3. EMITTER
- 4. COLLECTOR

STYLE 2:

- PIN 1. BASE
- 2. EMITTER
- 3. COLLECTOR
- 4. EMITTER

STYLE 3:

- PIN 1. CATHODE
- 2. ANODE
- 3. GATE
- 4. ANODE

STYLE 4:

- PIN 1. MAIN TERMINAL 1
- 2. MAIN TERMINAL 2
- 3. GATE
- 4. MAIN TERMINAL 2

STYLE 5:

- PIN 1. GATE
- 2. DRAIN
- 3. SOURCE
- 4. DRAIN

STYLE 6:

- PIN 1. ANODE
- 2. CATHODE
- 3. ANODE
- 4. CATHODE

STYLE 7:

- PIN 1. CATHODE
- 2. ANODE
- 3. CATHODE
- 4. ANODE

STYLE 8:

- PIN 1. CATHODE
- 2. ANODE
- 3. EXTERNAL TRIP/DELAY
- 4. ANODE

STYLE 9:

- PIN 1. GATE
- 2. COLLECTOR
- 3. EMITTER
- 4. COLLECTOR

STYLE 10:

- PIN 1. GATE
- 2. SOURCE
- 3. DRAIN
- 4. SOURCE

STYLE 11:

- PIN 1. DRAIN
- 2. SOURCE
- 3. GATE
- 4. SOURCE

STYLE 12:

- PIN 1. MAIN TERMINAL 1
- 2. MAIN TERMINAL 2
- 3. GATE
- 4. NOT CONNECTED

| | | |
|------------------|-------------|---|
| DOCUMENT NUMBER: | 98ASB42148B | Electronic versions are uncontrolled except when accessed directly from the Document Repository. Printed versions are uncontrolled except when stamped "CONTROLLED COPY" in red. |
| DESCRIPTION: | TO-220 | PAGE 1 OF 1 |

onsemi and ONSEMI are trademarks of Semiconductor Components Industries, LLC dba onsemi or its subsidiaries in the United States and/or other countries. onsemi reserves the right to make changes without further notice to any products herein. onsemi makes no warranty, representation or guarantee regarding the suitability of its products for any particular purpose, nor does onsemi assume any liability arising out of the application or use of any product or circuit, and specifically disclaims any and all liability, including without limitation special, consequential or incidental damages. onsemi does not convey any license under its patent rights nor the rights of others.

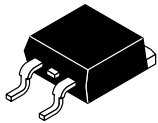

D²PAK 3
CASE 418B-04
ISSUE L

DATE 17 FEB 2015

SCALE 1:1

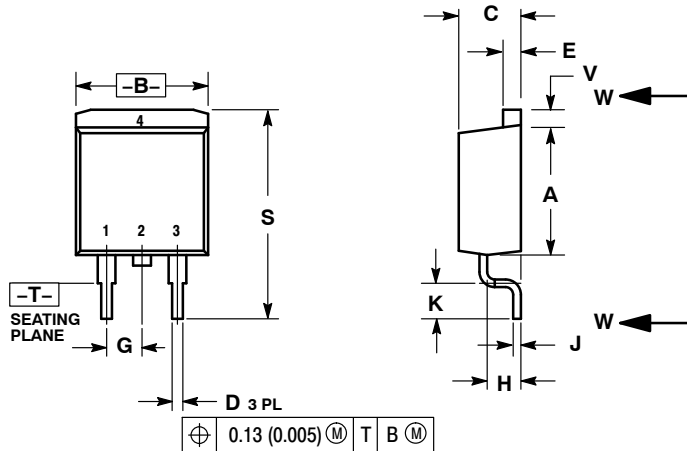

- NOTES:
1. DIMENSIONING AND TOLERANCING PER ANSI Y14.5M, 1982.
 2. CONTROLLING DIMENSION: INCH.
 3. 418B-01 THRU 418B-03 OBSOLETE, NEW STANDARD 418B-04.

| DIM | INCHES | | MILLIMETERS | |
|-----|--------|-------|-------------|-------|
| | MIN | MAX | MIN | MAX |
| A | 0.340 | 0.380 | 8.64 | 9.65 |
| B | 0.380 | 0.405 | 9.65 | 10.29 |
| C | 0.160 | 0.190 | 4.06 | 4.83 |
| D | 0.020 | 0.035 | 0.51 | 0.89 |
| E | 0.045 | 0.055 | 1.14 | 1.40 |
| F | 0.310 | 0.350 | 7.87 | 8.89 |
| G | 0.100 | BSC | 2.54 | BSC |
| H | 0.080 | 0.110 | 2.03 | 2.79 |
| J | 0.018 | 0.025 | 0.46 | 0.64 |
| K | 0.090 | 0.110 | 2.29 | 2.79 |
| L | 0.052 | 0.072 | 1.32 | 1.83 |
| M | 0.280 | 0.320 | 7.11 | 8.13 |
| N | 0.197 | REF | 5.00 | REF |
| P | 0.079 | REF | 2.00 | REF |
| R | 0.039 | REF | 0.99 | REF |
| S | 0.575 | 0.625 | 14.60 | 15.88 |
| V | 0.045 | 0.055 | 1.14 | 1.40 |

VARIABLE CONFIGURATION ZONE

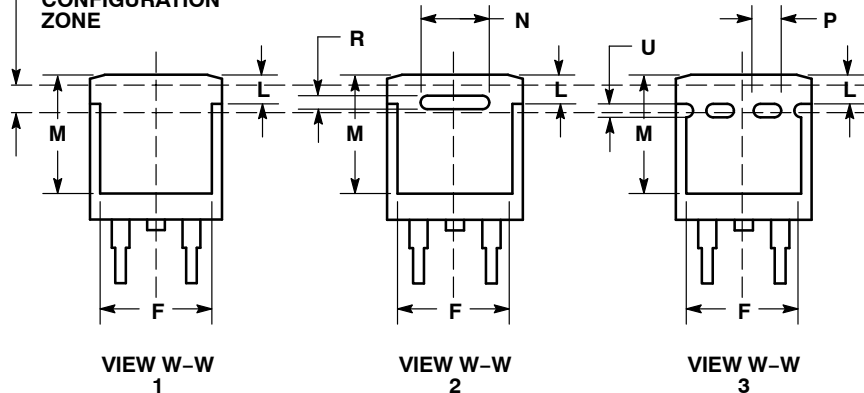

- | | | | | | |
|---|--|--|---|--|---|
| STYLE 1: PIN 1. BASE 2. COLLECTOR 3. EMITTER 4. COLLECTOR | STYLE 2: PIN 1. GATE 2. DRAIN 3. SOURCE 4. DRAIN | STYLE 3: PIN 1. ANODE 2. CATHODE 3. ANODE 4. CATHODE | STYLE 4: PIN 1. GATE 2. COLLECTOR 3. EMITTER 4. COLLECTOR | STYLE 5: PIN 1. CATHODE 2. ANODE 3. CATHODE 4. ANODE | STYLE 6: PIN 1. NO CONNECT 2. CATHODE 3. ANODE 4. CATHODE |
|---|--|--|---|--|---|

MARKING INFORMATION AND FOOTPRINT ON PAGE 2

| | | |
|------------------|----------------------|--|
| DOCUMENT NUMBER: | 98ASB42761B | Electronic versions are uncontrolled except when accessed directly from the Document Repository. Printed versions are uncontrolled except when stamped "CONTROLLED COPY" in red. |
| DESCRIPTION: | D ² PAK 3 | PAGE 1 OF 2 |

onsemi and ONSEMI are trademarks of Semiconductor Components Industries, LLC dba onsemi or its subsidiaries in the United States and/or other countries. onsemi reserves the right to make changes without further notice to any products herein. onsemi makes no warranty, representation or guarantee regarding the suitability of its products for any particular purpose, nor does onsemi assume any liability arising out of the application or use of any product or circuit, and specifically disclaims any and all liability, including without limitation special, consequential or incidental damages. onsemi does not convey any license under its patent rights nor the rights of others.

**GENERIC
MARKING DIAGRAM***

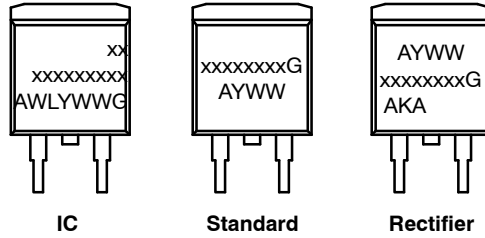

- xx = Specific Device Code
- A = Assembly Location
- WL = Wafer Lot
- Y = Year
- WW = Work Week
- G = Pb-Free Package
- AKA = Polarity Indicator

*This information is generic. Please refer to device data sheet for actual part marking. Pb-Free indicator, "G" or microdot "•", may or may not be present. Some products may not follow the Generic Marking.

SOLDERING FOOTPRINT*

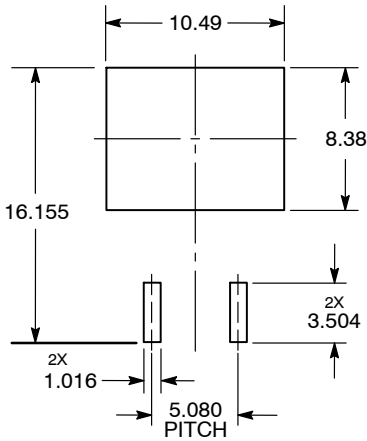

DIMENSIONS: MILLIMETERS

*For additional information on our Pb-Free strategy and soldering details, please download the **onsemi** Soldering and Mounting Techniques Reference Manual, SOLDERRM/D.

| | | |
|-------------------------|---------------------------|---|
| DOCUMENT NUMBER: | 98ASB42761B | Electronic versions are uncontrolled except when accessed directly from the Document Repository. Printed versions are uncontrolled except when stamped "CONTROLLED COPY" in red. |
| DESCRIPTION: | D²PAK 3 | PAGE 2 OF 2 |

onsemi and **ONSEMI** are trademarks of Semiconductor Components Industries, LLC dba **onsemi** or its subsidiaries in the United States and/or other countries. **onsemi** reserves the right to make changes without further notice to any products herein. **onsemi** makes no warranty, representation or guarantee regarding the suitability of its products for any particular purpose, nor does **onsemi** assume any liability arising out of the application or use of any product or circuit, and specifically disclaims any and all liability, including without limitation special, consequential or incidental damages. **onsemi** does not convey any license under its patent rights nor the rights of others.

onsemi, **Onsemi**, and other names, marks, and brands are registered and/or common law trademarks of Semiconductor Components Industries, LLC dba "**onsemi**" or its affiliates and/or subsidiaries in the United States and/or other countries. **onsemi** owns the rights to a number of patents, trademarks, copyrights, trade secrets, and other intellectual property. A listing of **onsemi**'s product/patent coverage may be accessed at www.onsemi.com/site/pdf/Patent-Marking.pdf. **onsemi** reserves the right to make changes at any time to any products or information herein, without notice. The information herein is provided "as-is" and **onsemi** makes no warranty, representation or guarantee regarding the accuracy of the information, product features, availability, functionality, or suitability of its products for any particular purpose, nor does **onsemi** assume any liability arising out of the application or use of any product or circuit, and specifically disclaims any and all liability, including without limitation special, consequential or incidental damages. Buyer is responsible for its products and applications using **onsemi** products, including compliance with all laws, regulations and safety requirements or standards, regardless of any support or applications information provided by **onsemi**. "Typical" parameters which may be provided in **onsemi** data sheets and/or specifications can and do vary in different applications and actual performance may vary over time. All operating parameters, including "Typicals" must be validated for each customer application by customer's technical experts. **onsemi** does not convey any license under any of its intellectual property rights nor the rights of others. **onsemi** products are not designed, intended, or authorized for use as a critical component in life support systems or any FDA Class 3 medical devices or medical devices with a same or similar classification in a foreign jurisdiction or any devices intended for implantation in the human body. Should Buyer purchase or use **onsemi** products for any such unintended or unauthorized application, Buyer shall indemnify and hold **onsemi** and its officers, employees, subsidiaries, affiliates, and distributors harmless against all claims, costs, damages, and expenses, and reasonable attorney fees arising out of, directly or indirectly, any claim of personal injury or death associated with such unintended or unauthorized use, even if such claim alleges that **onsemi** was negligent regarding the design or manufacture of the part. **onsemi** is an Equal Opportunity/Affirmative Action Employer. This literature is subject to all applicable copyright laws and is not for resale in any manner.

ADDITIONAL INFORMATION

TECHNICAL PUBLICATIONS:

Technical Library: www.onsemi.com/design/resources/technical-documentation
onsemi Website: www.onsemi.com

ONLINE SUPPORT: www.onsemi.com/support

For additional information, please contact your local Sales Representative at www.onsemi.com/support/sales