

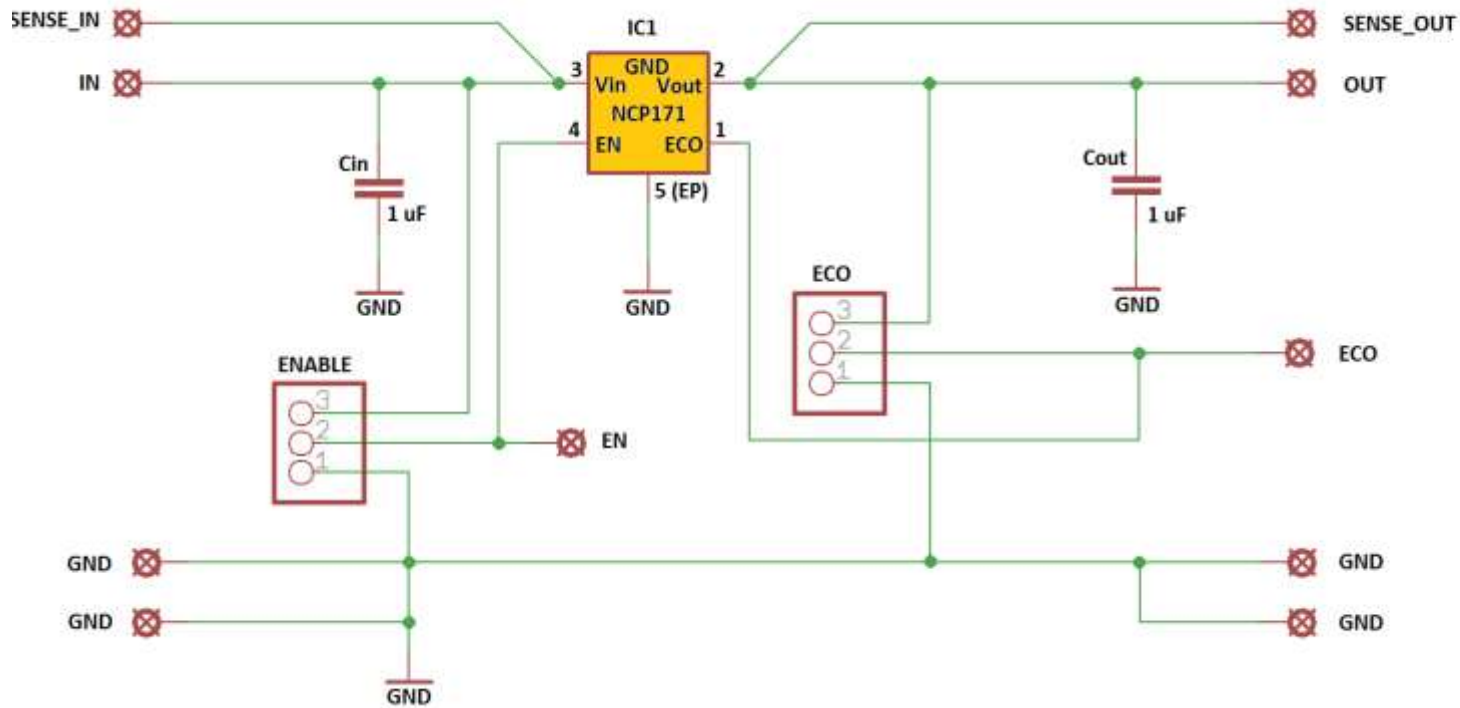

ON Semiconductor

Schematic for the NCP171AMX280275TCG LDO Demoboard



Programming I/F

