

NCP708

Voltage Regulator - 1% Precision, Very Low Dropout, Enable

1 A

The NCP708 is a Very Low Dropout Regulator which provides up to 1 A of load current and maintains excellent output voltage accuracy of 1.5% including line, load and temperature variations. The operating input voltage range from 2.4 V up to 5.5 V makes this device suitable for Li-ion battery powered products as well as post-regulation applications. The product is available in 3.3 V fixed output voltage option. Other voltage options are possible on request. NCP708 is fully protected against overheating and output short circuit.

Small 6-pin UDFN6 3x3 package makes the device especially suitable for space constrained applications.

Features

- Operating Input Voltage Range: 2.4 V to 5.5 V
- Fixed Output Voltage Option: 3.3 V
Other Output Voltage Options Available on Request.
- Low Quiescent Current of Typ. 200 μ A
- Very Low Dropout: 250 mV Max. at $I_{OUT} = 1$ A
- $\pm 1.5\%$ Accuracy Over Load/Line/Temperature
- High PSRR: 70 dB at 1 kHz
- Internal Soft-Start to Limit the Inrush Current
- Thermal Shutdown and Current Limit Protections
- Stable with a 4.7 μ F Ceramic Output Capacitor
- Available in UDFN6 3x3 mm Package
- These are Pb-Free Devices

Typical Applications

- Hard-Drives, SSDs
- Servers, Networking Equipment
- Telecom Equipment
- Battery Powered Applications

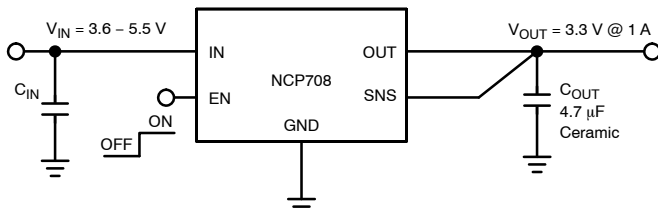

Figure 1. Typical Application Schematic



ON Semiconductor®

www.onsemi.com



UDFN6
CASE 517DD

MARKING DIAGRAM

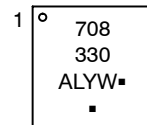

- A = Assembly Location
- L = Wafer Lot
- Y = Year
- W = Work Week
- = Pb-Free Package

(Note: Microdot may be in either location)

PIN CONNECTION

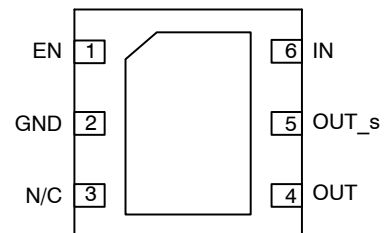

(Top View)

ORDERING INFORMATION

See detailed ordering, marking and shipping information on page 8 of this data sheet.

NCP708

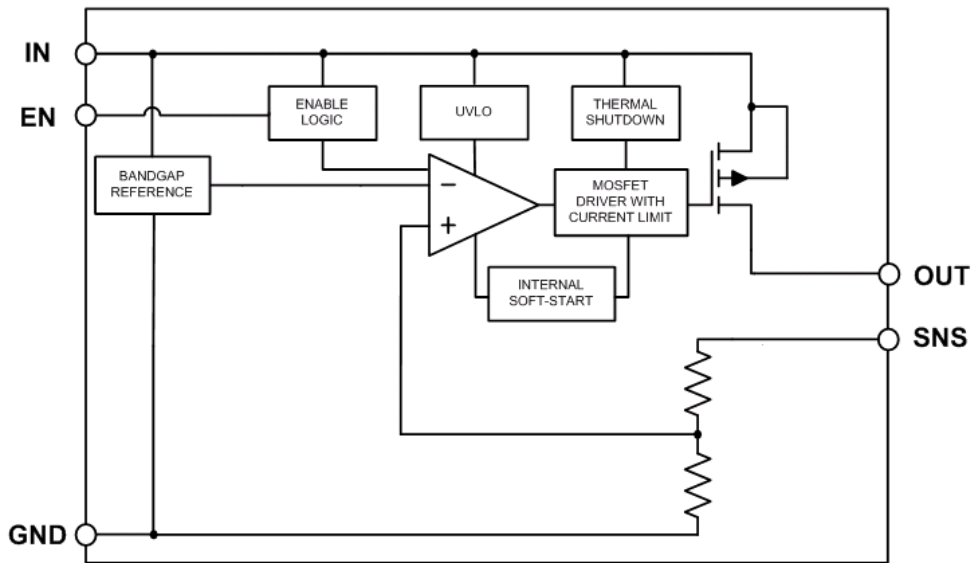

Figure 2. Simplified Internal Schematic Block Diagram

PIN FUNCTION DESCRIPTION

Pin No.	Pin Name	Description
1	EN	Enable pin. Driving EN over 0.9 V turns on the regulator. Driving EN below 0.4 V puts the regulator into shutdown mode.
2	GND	Power supply ground.
3	N/C	Not connected. This pin can be tied to ground to improve thermal dissipation.
4	OUT	Regulated output voltage. A minimum 4.7 μ F ceramic capacitor is needed from this pin to ground to assure stability.
5	OUT_S	Output voltage sense connection. This pin should be connected to the output voltage rail.
6	IN	Input pin. A small capacitor is needed from this pin to ground to assure stability.
-	Exposed Pad	This pad enhances thermal performance and is electrically connected to GND. It is recommended that the exposed pad is connected to the ground plane on the board or otherwise left open.

NCP708

ABSOLUTE MAXIMUM RATINGS

Rating	Symbol	Value	Unit
Input Voltage (Note 1)	V_{IN}	-0.3 V to 6 V	V
Output Voltage	V_{OUT}	-0.3 V to $V_{IN} + 0.3$ V	V
Enable Input	V_{EN}	-0.3 V to $V_{IN} + 0.3$ V	V
Output Short Circuit Duration	t_{SC}	Indefinite	s
Maximum Junction Temperature	$T_{J(MAX)}$	150	°C
Storage Temperature	T_{STG}	-55 to 150	°C
ESD Capability, Human Body Model (Note 2)	ESD_{HBM}	2000	V
ESD Capability, Machine Model (Note 2)	ESD_{MM}	200	V

Stresses exceeding those listed in the Maximum Ratings table may damage the device. If any of these limits are exceeded, device functionality should not be assumed, damage may occur and reliability may be affected.

1. Refer to ELECTRICAL CHARACTERISTICS and APPLICATION INFORMATION for Safe Operating Area.
2. This device series incorporates ESD protection and is tested by the following methods:
 - ESD Human Body Model tested per EIA/JESD22-A114
 - ESD Machine Model tested per EIA/JESD22-A115
 - Latch-up Current Maximum Rating tested per JEDEC standard: JESD78

THERMAL CHARACTERISTICS

Rating	Symbol	Value	Unit
Thermal Characteristics, WDFN6 3 x 3, Thermal Resistance, Junction-to-Air	$R_{\theta JA}$	55	°C/W

NCP708

ELECTRICAL CHARACTERISTICS – VOLTAGE VERSION 3.3 V

$-40^{\circ}\text{C} \leq T_J \leq 125^{\circ}\text{C}$; $V_{IN} = V_{OUT(NOM)} + 0.3\text{ V}$ or 2.4 V , whichever is greater; $I_{OUT} = 10\text{ mA}$, $C_{IN} = C_{OUT} = 4.7\text{ }\mu\text{F}$, $V_{EN} = 0.9\text{ V}$, unless otherwise noted. Typical values are at $T_J = +25^{\circ}\text{C}$. (Note 3)

Parameter	Test Conditions	Symbol	Min	Typ	Max	Unit
Operating Input Voltage		V_{IN}	2.4		5.5	V
Undervoltage lock-out	V_{IN} rising	UVLO	1.2	1.6	1.9	V
Output Voltage Accuracy	$V_{OUT} + 0.3\text{ V} \leq V_{IN} \leq 5.25\text{ V}$, $I_{OUT} = 0 - 1\text{ A}$	V_{OUT}	3.25	3.3	3.35	V
Line Regulation	$V_{OUT} + 0.3\text{ V} \leq V_{IN} \leq 5.25\text{ V}$, $I_{OUT} = 10\text{ mA}$	Reg _{LINE}		2		mV
Load Regulation	$I_{OUT} = 0\text{ mA}$ to 1 A	Reg _{LOAD}		2		mV
Load Transient	Any 200 mA load step from $I_{OUT} = 10\text{ mA}$ to 1 A or 10 mA to 1 A in $10\text{ }\mu\text{s}$, $C_{OUT} = 10\text{ }\mu\text{F}$	Tran _{LOAD}		± 60		mV
Dropout voltage (Note 4)	$I_{OUT} = 1\text{ A}$, $V_{OUT(nom)} = 3.3\text{ V}$	V_{DO}		220	330	mV
Output Current Limit	$V_{OUT} = 90\% V_{OUT(nom)}$	I_{CL}	1.1			A
Quiescent current	$I_{OUT} = 0\text{ mA}$	I_Q		180	230	μA
Ground current	$I_{OUT} = 1\text{ A}$	I_{GND}		200		μA
Shutdown current	$V_{EN} \leq 0\text{ V}$, $V_{IN} = 2.0$ to 5.5 V			0.1	1	μA
Reverse Leakage Current in Shutdown	$V_{IN} = 5.5\text{ V}$, $V_{OUT} = V_{OUT(NOM)}$, $V_{EN} < 0.4\text{ V}$	I_{REV}		1.5	5	μA
EN Pin High Threshold	V_{EN} Voltage increasing	V_{EN_HI}	0.9			V
EN Pin Low Threshold	V_{EN} Voltage decreasing	V_{EN_LO}			0.4	V
EN Pin Input Current	$V_{EN} = 5.5\text{ V}$	I_{EN}		100	500	nA
Turn-on Time	$C_{OUT} = 4.7\text{ }\mu\text{F}$, from assertion EN pin to 98% $V_{out(nom)}$	t_{ON}		200		μs
Power Supply Rejection Ratio	$V_{IN} = 3.8\text{ V}$, $V_{OUT} = 3.3\text{ V}$, $I_{OUT} = 0.1\text{ A}$	$f = 1\text{ kHz}$ PSRR		70		dB
Output Noise Voltage	$V_{OUT} = 3.3\text{ V}$, $V_{IN} = 3.6\text{ V}$, $I_{OUT} = 0.1\text{ A}$ $f = 200\text{ Hz}$ to 100 kHz	V_{NOISE}		100		μV_{rms}
Thermal Shutdown Temperature	Temperature increasing from $T_J = +25^{\circ}\text{C}$	T_{SD}		160		$^{\circ}\text{C}$
Thermal Shutdown Hysteresis	Temperature falling from T_{SD}	T_{SDH}	-	20	-	$^{\circ}\text{C}$

Product parametric performance is indicated in the Electrical Characteristics for the listed test conditions, unless otherwise noted. Product performance may not be indicated by the Electrical Characteristics if operated under different conditions.

- Performance guaranteed over the indicated operating temperature range by design and/or characterization production tested at $T_J = T_A = 25^{\circ}\text{C}$. Low duty cycle pulse techniques are used during testing to maintain the junction temperature as close to ambient as possible.
- Characterized when V_{OUT} falls 100 mV below the regulated voltage at $V_{IN} = V_{OUT(NOM)} + 0.3\text{ V}$.

TYPICAL CHARACTERISTICS

$V_{IN} = V_{OUT-NOM} + 0.3\text{ V}$ or $V_{IN} = 2.4\text{ V}$ whatever is greater, $V_{EN} = 0.9\text{ V}$, $I_{OUT} = 10\text{ mA}$, $C_{IN} = C_{OUT} = 4.7\text{ }\mu\text{F}$, $T_J = 25^{\circ}\text{C}$.

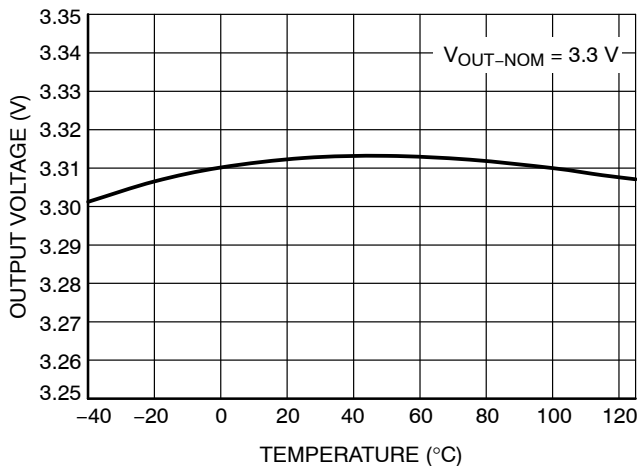

Figure 3. Output Voltage vs. Temperature

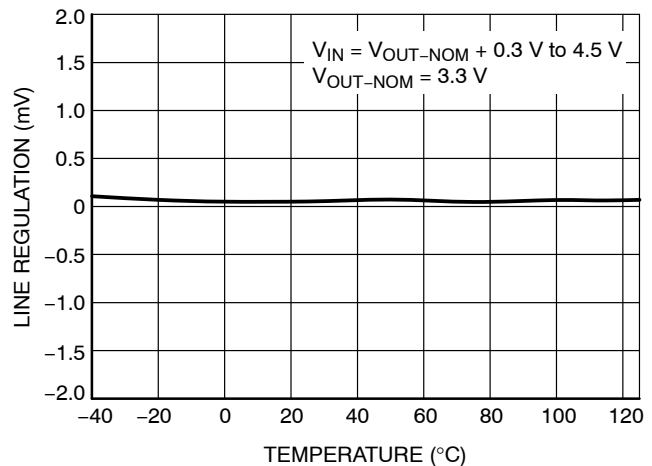

Figure 4. Line Regulation vs. Temperature

NCP708

TYPICAL CHARACTERISTICS

$V_{IN} = V_{OUT-NOM} + 0.3 \text{ V}$ or $V_{IN} = 2.4 \text{ V}$ whatever is greater, $V_{EN} = 0.9 \text{ V}$, $I_{OUT} = 10 \text{ mA}$, $C_{IN} = C_{OUT} = 4.7 \mu\text{F}$, $T_J = 25^\circ\text{C}$.

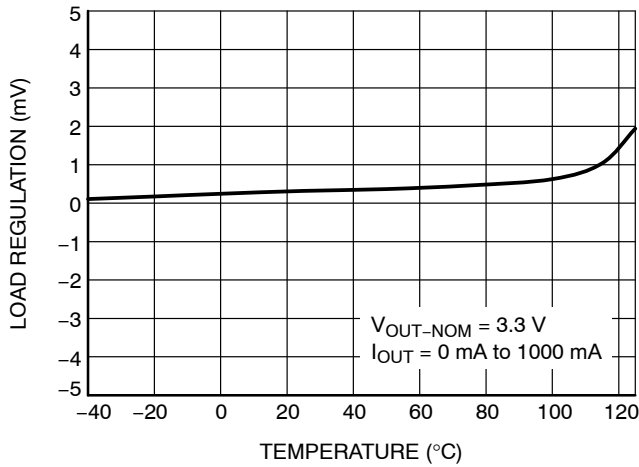

Figure 5. Load Regulation vs. Temperature

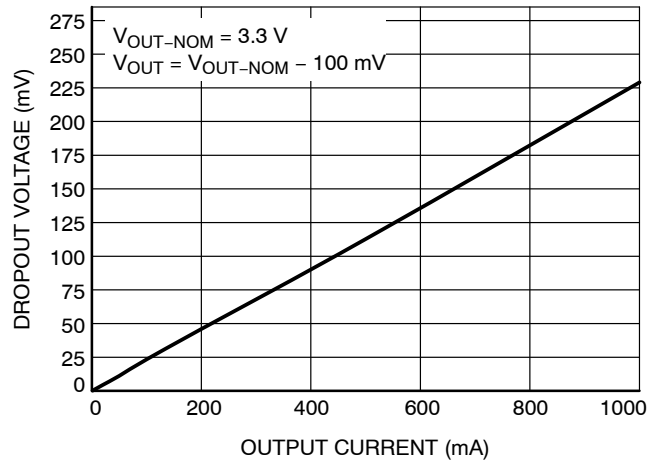

Figure 6. Dropout Voltage vs. Output Current

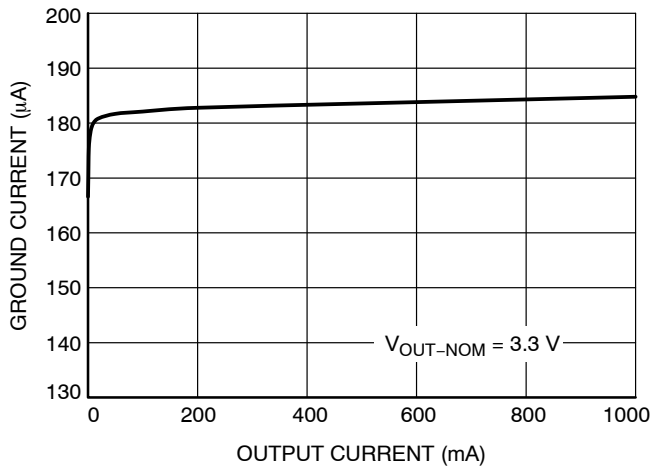

Figure 7. Ground Current vs. Output Current

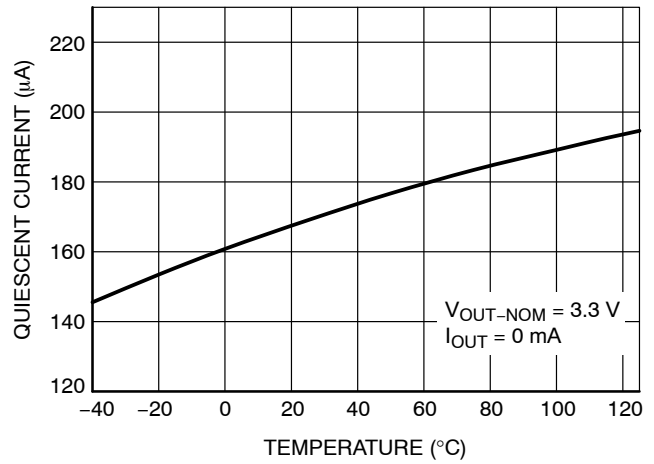

Figure 8. Quiescent Current vs. Temperature

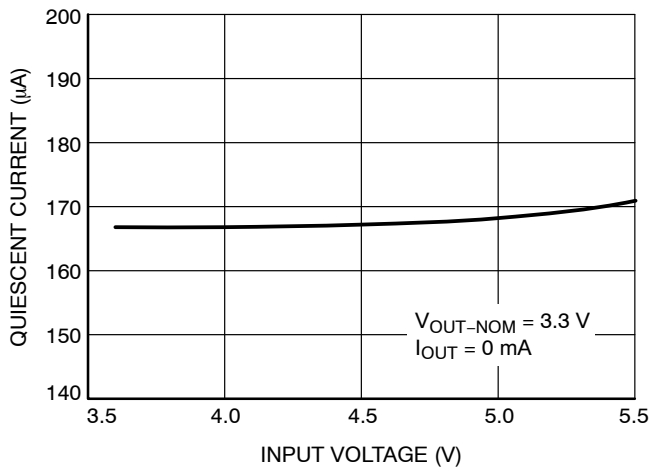

Figure 9. Quiescent Current vs. Input Voltage

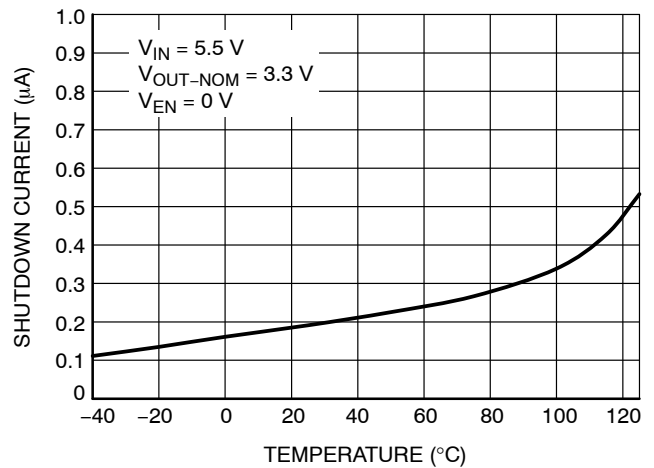

Figure 10. Shutdown Current vs. Temperature

NCP708

TYPICAL CHARACTERISTICS

$V_{IN} = V_{OUT-NOM} + 0.3\text{ V}$ or $V_{IN} = 2.4\text{ V}$ whatever is greater, $V_{EN} = 0.9\text{ V}$, $I_{OUT} = 10\text{ mA}$, $C_{IN} = C_{OUT} = 4.7\text{ }\mu\text{F}$, $T_J = 25^\circ\text{C}$.

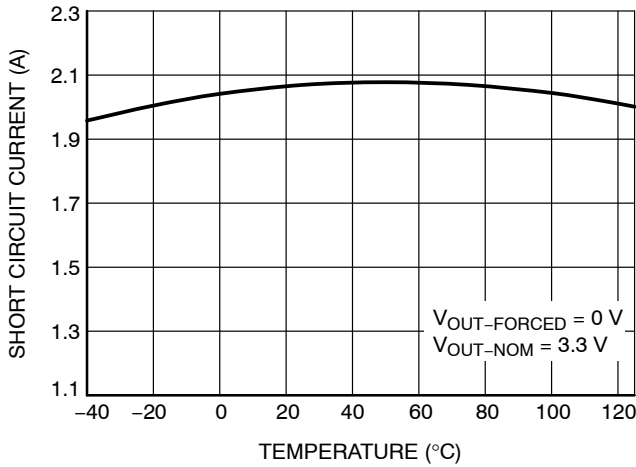

Figure 11. Short Circuit Current vs. Temperature

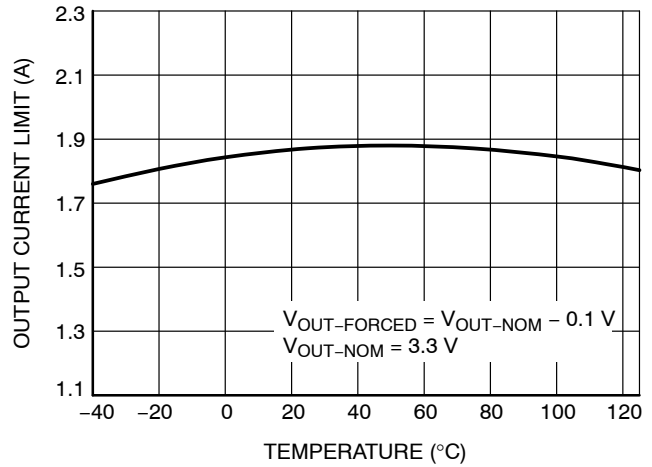

Figure 12. Output Current Limit vs. Temperature

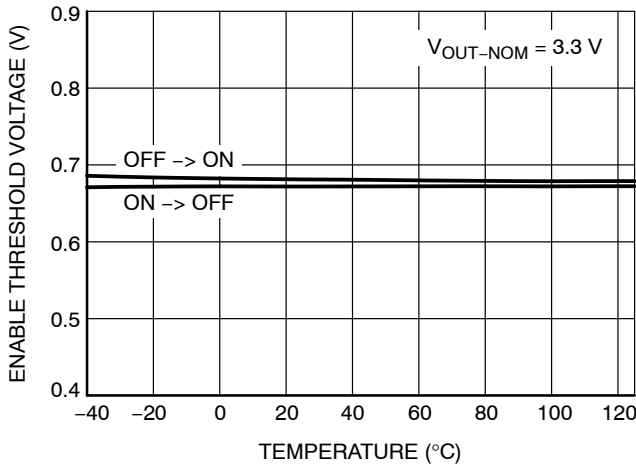

Figure 13. Enable Threshold Voltage vs. Temperature

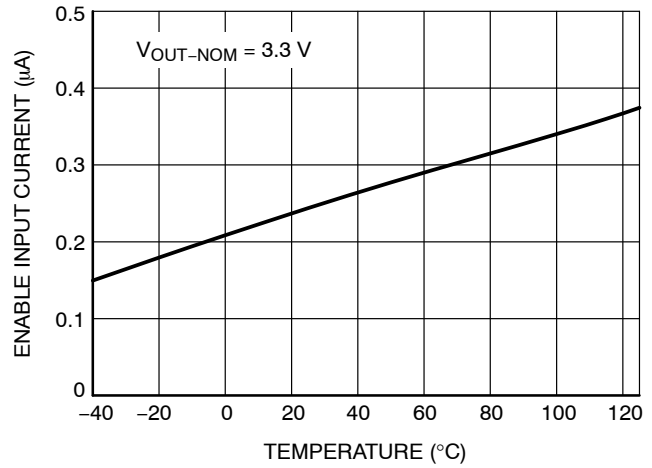

Figure 14. Enable Input Current vs. Temperature

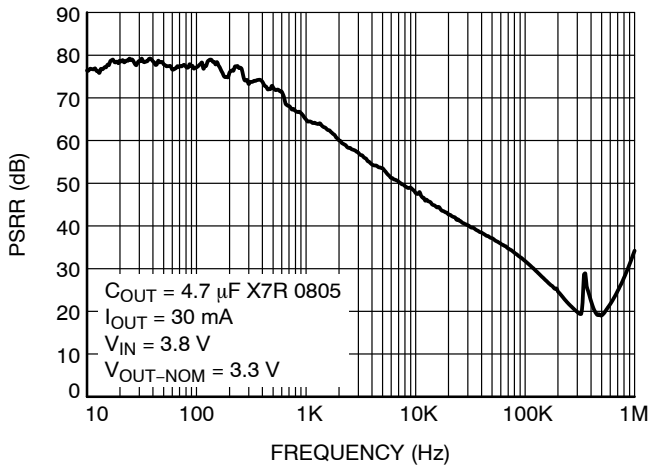

Figure 15. Power Supply Rejection Ratio

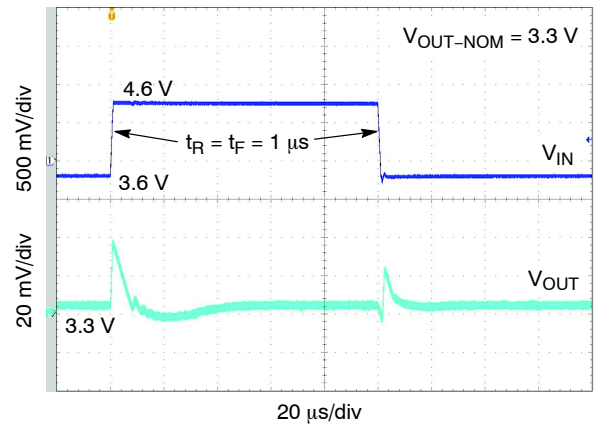

Figure 16. Line Transient Response

NCP708

TYPICAL CHARACTERISTICS

$V_{IN} = V_{OUT-NOM} + 0.3 \text{ V}$ or $V_{IN} = 2.4 \text{ V}$ whatever is greater, $V_{EN} = 0.9 \text{ V}$, $I_{OUT} = 10 \text{ mA}$, $C_{IN} = C_{OUT} = 4.7 \mu\text{F}$, $T_J = 25^\circ\text{C}$.

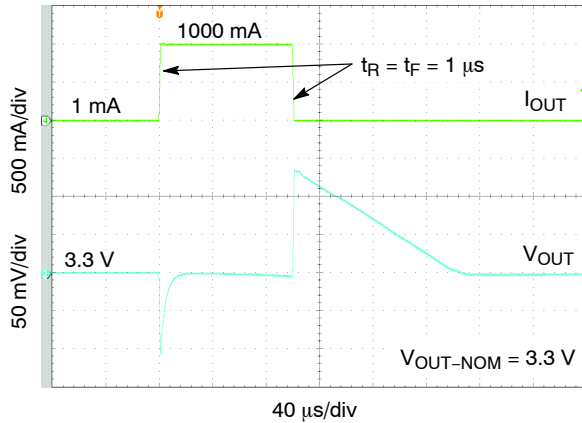

Figure 17. Load Transient Response

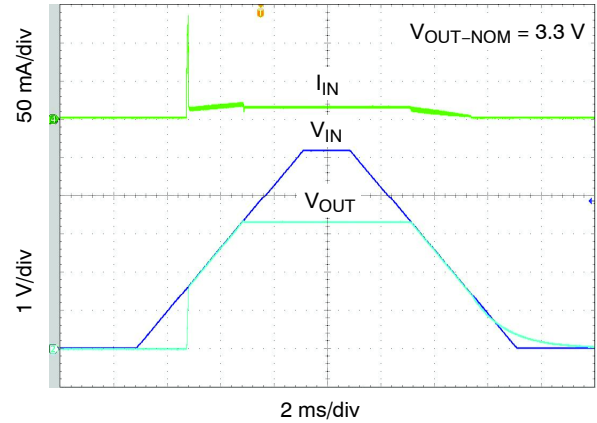

Figure 18. Turn-ON/OFF – VIN Driven (slow)

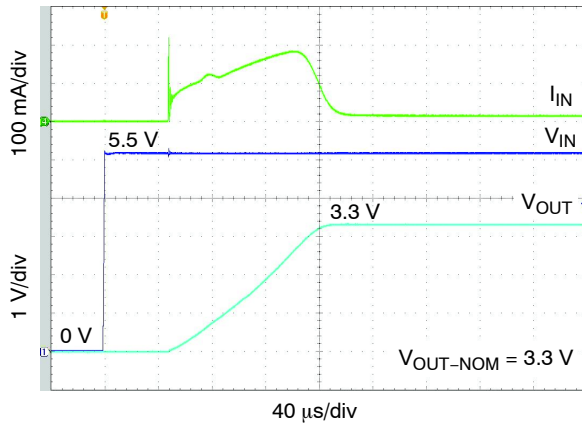

Figure 19. Turn-ON/OFF – VIN Driven (fast)

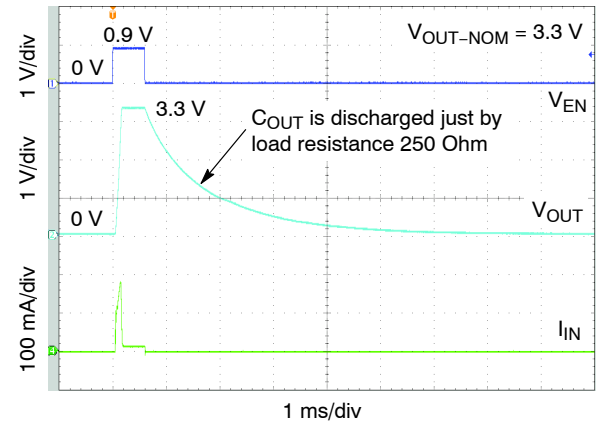

Figure 20. Turn-ON/OFF – EN Driven

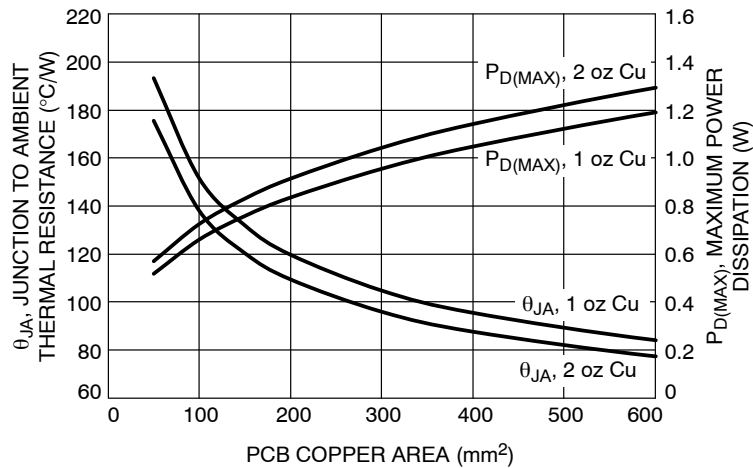

Figure 21. θ_{JA} and $P_{D(MAX)}$ vs. Copper Area

NCP708

APPLICATIONS INFORMATION

Input Decoupling (C_{in})

A 4.7 μ F capacitor either ceramic or tantalum is recommended and should be connected as close as possible to the pins of NCP708 device. Higher values and lower ESR will improve the overall line transient response.

Output Decoupling (C_{out})

The minimum decoupling value is 4.7 μ F and can be augmented to fulfill stringent load transient requirements. The regulator accepts ceramic chip capacitors MLCC. If a tantalum capacitor is used, and its ESR is large, the loop oscillation may result. Larger values improve noise rejection and PSRR.

Enable Operation

The enable pin EN will turn on or off the regulator. These limits of threshold are covered in the electrical specification section of this data sheet. If the enable is not used then the pin should be connected to V_{IN}.

Hints

Please be sure the V_{in} and GND lines are sufficiently wide. If their impedance is high, noise pickup or unstable operation may result.

Set external components, especially the output capacitor, as close as possible to the circuit.

The sense pin SNS trace is recommended to be kept as far from noisy power traces as possible and as close to load as possible.

Thermal

As power across the NCP708 increases, it might become necessary to provide some thermal relief. The maximum power dissipation supported by the device is dependent upon board design and layout. Mounting pad configuration on the PCB, the board material, and also the ambient temperature affect the rate of temperature rise for the part. This is stating that when the NCP708 has good thermal conductivity through the PCB, the junction temperature will be relatively low with high power dissipation.

The power dissipation across the device can be roughly represented by the equation:

$$P_D = (V_{IN} - V_{OUT}) * I_{OUT} \text{ [W]} \quad (\text{eq. 1})$$

The maximum power dissipation depends on the thermal resistance of the case and circuit board, the temperature differential between the junction and ambient, PCB orientation and the rate of air flow.

The maximum allowable power dissipation can be calculated using the following equation:

$$P_{MAX} = (T_J - T_A) / \theta_{JA} \text{ [W]} \quad (\text{eq. 2})$$

Where (T_J - T_A) is the temperature differential between the junction and the surrounding environment and θ_{JA} is the thermal resistance from the junction to the ambient.

Connecting the exposed pad and non connected pin 3 to a large ground pad or plane helps to conduct away heat and improves thermal relief.

ORDERING INFORMATION

Device	Nominal Output Voltage	Package	Shipping [†]
NCP708MU330TAG	3.3 V	UDFN6 3 x 3 (Pb-Free)	3000 / Tape & Reel

[†]For information on tape and reel specifications, including part orientation and tape sizes, please refer to our Tape and Reel Packaging Specifications Brochure, BRD8011/D.



SCALE 2:1

UDFN6 3x3, 0.95P
CASE 517DD
ISSUE O

DATE 28 OCT 2014

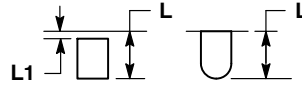
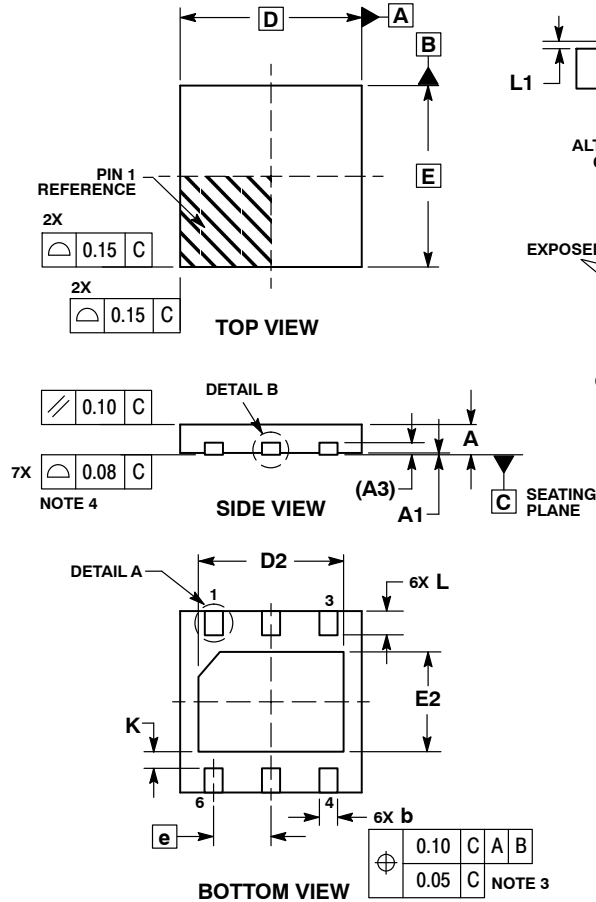

DETAIL A
ALTERNATE TERMINAL
CONSTRUCTIONS



DETAIL B
ALTERNATE
CONSTRUCTIONS

NOTES:

1. DIMENSIONS AND TOLERANCING PER ASME Y14.5M, 1994.
2. CONTROLLING DIMENSION: MILLIMETERS.
3. DIMENSION b APPLIES TO PLATED TERMINAL AND IS MEASURED BETWEEN 0.15 AND 0.30 MM FROM THE TERMINAL TIP.
4. COPLANARITY APPLIES TO THE EXPOSED PAD AS WELL AS THE TERMINALS.

MILLIMETERS		
DIM	MIN	MAX
A	0.45	0.55
A1	0.00	0.05
A3	0.20 REF	
b	0.25	0.35
D	3.00 BSC	
D2	2.30	2.50
E	3.00 BSC	
E2	1.55	1.75
e	0.95 BSC	
K	0.28 REF	
L	0.30	0.50
L1	---	0.15

GENERIC
MARKING DIAGRAM*

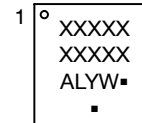

- XXXXX = Specific Device Code
- A = Assembly Location
- L = Wafer Lot
- Y = Year
- W = Work Week
- = Pb-Free Package

(Note: Microdot may be in either location)

*This information is generic. Please refer to device data sheet for actual part marking.

Pb-Free indicator, "G" or microdot "▪", may or may not be present.

RECOMMENDED
SOLDERING FOOTPRINT*

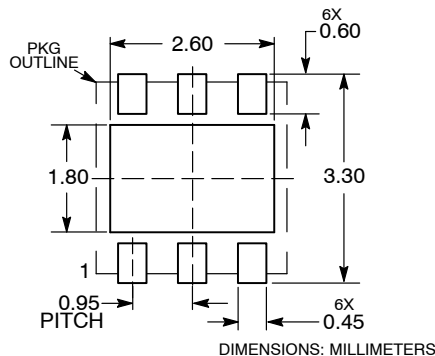

*For additional information on our Pb-Free strategy and soldering details, please download the onsemi Soldering and Mounting Techniques Reference Manual, SOLDERRM/D.

DOCUMENT NUMBER:	98AON92479F	Electronic versions are uncontrolled except when accessed directly from the Document Repository. Printed versions are uncontrolled except when stamped "CONTROLLED COPY" in red.
DESCRIPTION:	UDFN6 3X3, 0.95P	PAGE 1 OF 1

onsemi and ONSEMI are trademarks of Semiconductor Components Industries, LLC dba onsemi or its subsidiaries in the United States and/or other countries. onsemi reserves the right to make changes without further notice to any products herein. onsemi makes no warranty, representation or guarantee regarding the suitability of its products for any particular purpose, nor does onsemi assume any liability arising out of the application or use of any product or circuit, and specifically disclaims any and all liability, including without limitation special, consequential or incidental damages. onsemi does not convey any license under its patent rights nor the rights of others.

onsemi, **Onsemi**, and other names, marks, and brands are registered and/or common law trademarks of Semiconductor Components Industries, LLC dba "**onsemi**" or its affiliates and/or subsidiaries in the United States and/or other countries. **onsemi** owns the rights to a number of patents, trademarks, copyrights, trade secrets, and other intellectual property. A listing of **onsemi**'s product/patent coverage may be accessed at www.onsemi.com/site/pdf/Patent-Marking.pdf. **onsemi** reserves the right to make changes at any time to any products or information herein, without notice. The information herein is provided "as-is" and **onsemi** makes no warranty, representation or guarantee regarding the accuracy of the information, product features, availability, functionality, or suitability of its products for any particular purpose, nor does **onsemi** assume any liability arising out of the application or use of any product or circuit, and specifically disclaims any and all liability, including without limitation special, consequential or incidental damages. Buyer is responsible for its products and applications using **onsemi** products, including compliance with all laws, regulations and safety requirements or standards, regardless of any support or applications information provided by **onsemi**. "Typical" parameters which may be provided in **onsemi** data sheets and/or specifications can and do vary in different applications and actual performance may vary over time. All operating parameters, including "Typicals" must be validated for each customer application by customer's technical experts. **onsemi** does not convey any license under any of its intellectual property rights nor the rights of others. **onsemi** products are not designed, intended, or authorized for use as a critical component in life support systems or any FDA Class 3 medical devices or medical devices with a same or similar classification in a foreign jurisdiction or any devices intended for implantation in the human body. Should Buyer purchase or use **onsemi** products for any such unintended or unauthorized application, Buyer shall indemnify and hold **onsemi** and its officers, employees, subsidiaries, affiliates, and distributors harmless against all claims, costs, damages, and expenses, and reasonable attorney fees arising out of, directly or indirectly, any claim of personal injury or death associated with such unintended or unauthorized use, even if such claim alleges that **onsemi** was negligent regarding the design or manufacture of the part. **onsemi** is an Equal Opportunity/Affirmative Action Employer. This literature is subject to all applicable copyright laws and is not for resale in any manner.

ADDITIONAL INFORMATION

TECHNICAL PUBLICATIONS:

Technical Library: www.onsemi.com/design/resources/technical-documentation
onsemi Website: www.onsemi.com

ONLINE SUPPORT: www.onsemi.com/support

For additional information, please contact your local Sales Representative at www.onsemi.com/support/sales