

NOA3315

Digital Proximity Sensor with Dual Ambient Light Sensors and Interrupt

Description

The NOA3315 combines an advanced digital proximity sensor and LED driver with dual ambient light sensors (ALS) and tri-mode I²C interface with interrupt capability in an integrated monolithic device. Multiple power management features and very low active sensing power consumption directly address the power requirements of battery operated mobile phones and mobile internet devices.

The proximity sensor measures reflected light intensity with a high degree of precision and excellent ambient light rejection. The NOA3315 enables a proximity sensor system with a 16:1 programmable LED drive current range and a 30 dB overall proximity detection range. The dual ambient light sensors include one with a photopic light filter and one with no filter. Both have dark current compensation and high sensitivity eliminating inaccurate light level detection and insuring proper backlight control even in the presence of dark cover glass.

The NOA3315 is ideal for improving the user experience by enhancing the screen interface with the ability to measure distance for near/far detection in real time and the ability to respond to ambient lighting conditions to control display backlight intensity.

Features

- Proximity Sensor, LED Driver and Dual ALS in One Device
- Very Low Power Consumption
 - ◆ Stand-by current 2.8 μ A (monitoring I²C interface only, V_{dd} = 3 V)
 - ◆ ALS operational current 50 μ A per sensor
 - ◆ Proximity sensing average operational current 100 μ A
 - ◆ Average LED sink current 75 μ A
- These Devices are Pb-Free, Halogen Free/BFR Free and are RoHS Compliant

Proximity Sensing

- Proximity detection distance threshold I²C programmable with 12-bit resolution and eight integration time ranges (16-bit effective resolution)
- Effective for Measuring Distances up to 200 mm and Beyond
- Excellent IR and Ambient Light Rejection including Sunlight (up to 50K lux) and CFL Interference
- Programmable LED Drive Current from 10 mA to 160 mA in 5 mA Steps, no External Resistor Required
- User Programmable LED Pulse Frequency



ON Semiconductor®

www.onsemi.com

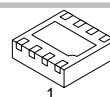

CUDFN8
CU SUFFIX
CASE 505AP

PIN CONNECTIONS

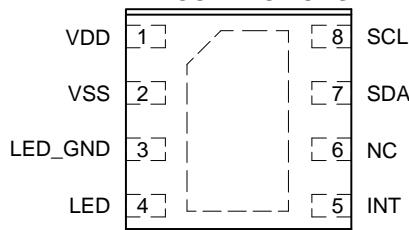

(Top View)

ORDERING INFORMATION

Device	Package	Shipping
NOA3315CUTAG*	CUDFN8 (Pb-Free)	2500 / Tape & Reel

*Temperature Range: -40°C to 80°C.

Ambient Light Sensing

- Dual ALS senses ambient light and provides 16-bit output counts on the I²C bus directly proportional to the ambient light intensity
- Photopic Spectral Response of ALS1 Nearly Matches Human Eye
- Broadband response of ALS2 supports compensation for spectral shifts encountered with different types of cover glass
- Dynamic Dark Current Compensation
- Linear Response over the Full Operating Range
- 3 ranges – 100 counts/lux, 10 counts/lux, 1 count/lux
- Senses Intensity of Ambient Light from 0.02 lux to 52k lux with 21-bit Effective Resolution (16-bit converter)
- Programmable Integration Times (50 ms, 100 ms, 200 ms, 400 ms)

Additional Features

- Programmable interrupt function including independent upper and lower threshold detection or threshold based hysteresis for proximity and or ALS
- Level or Edge Triggered Interrupts
- Proximity persistence feature reduces interrupts by providing hysteresis to filter fast transients such as camera flash

NOA3315

- Automatic power down after single measurement or continuous measurements with programmable interval time for both ALS and PS functions
- Wide Operating Voltage Range (2.3 V to 3.6 V)
- Wide Operating Temperature Range (-40°C to 80°C)
- I²C Serial Communication Port
 - ◆ Standard mode – 100 kHz
 - ◆ Fast mode – 400 kHz
 - ◆ High speed mode – 3.4 MHz

- No External Components Required except the IR LED and Power Supply Decoupling Caps

Applications

- Senses human presence in terms of distance and senses ambient light conditions, saving display power in applications such as:
 - ◆ Smart phones, mobile internet devices, MP3 players, GPS
 - ◆ Mobile device displays and backlit keypads

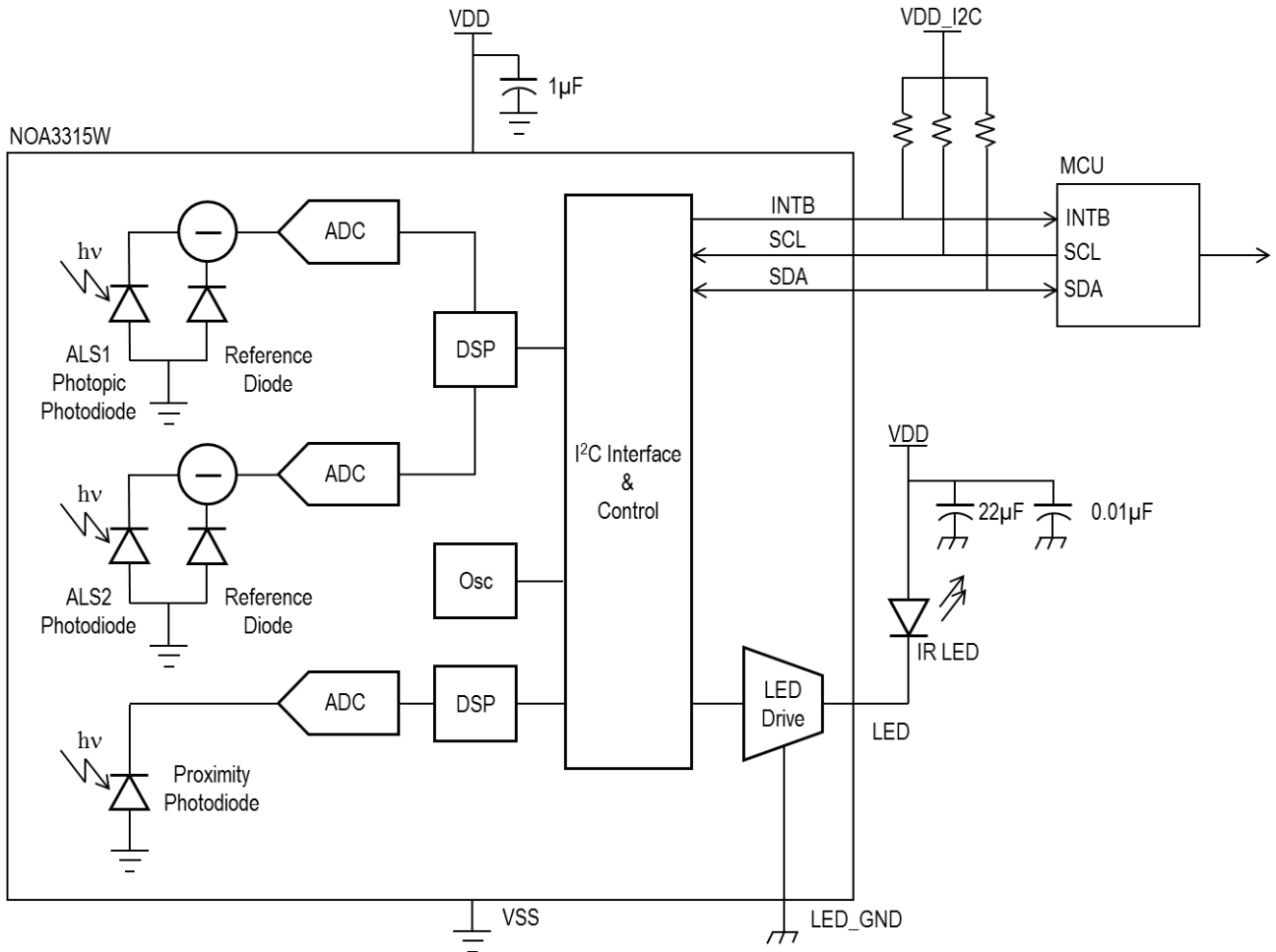

Figure 1. NOA3315 Application Block Diagram

Table 1. PAD FUNCTION DESCRIPTION

Pad	Pad Name	Description
1	VDD	Power pad
2	VSS	Ground pad
3	LED_GND	Ground pad for IR LED driver
4	LED	IR LED output pad
5	INT	Interrupt output pad, open-drain
6	SDA	Bi-directional data signal for communications with the I ² C master
7	SCL	External I2C clock supplied by the I2C master

Table 2. ABSOLUTE MAXIMUM RATINGS

Rating	Symbol	Value	Unit
Input power supply	VDD	4.0	V
Input voltage range	V _{in}	-0.3 to VDD + 0.2	V
Output voltage range	V _{out}	-0.3 to VDD + 0.2	V
Maximum Junction Temperature	T _{J(max)}	100	°C
Storage Temperature	T _{STG}	-40 to 80	°C
ESD Capability, Human Body Model (Note 1)	ESD _{HBM}	2	kV
ESD Capability, Charged Device Model (Note 1)	ESD _{CDM}	500	V
Moisture Sensitivity Level	MSL	3	-
Lead Temperature Soldering (Note 2)	T _{SLD}	260	°C

Stresses exceeding those listed in the Maximum Ratings table may damage the device. If any of these limits are exceeded, device functionality should not be assumed, damage may occur and reliability may be affected.

1. This device incorporates ESD protection and is tested by the following methods:

ESD Human Body Model tested per EIA/JESD22-A114

ESD Charged Device Model tested per ESD-STM5.3.1-1999

Latchup Current Maximum Rating: ≤ 100 mA per JEDEC standard: JESD78

2. For information, please refer to our Soldering and Mounting Techniques Reference Manual, SOLDERRM/D

Table 3. OPERATING RANGES

Rating	Symbol	Min	Typ	Max	Unit
Power supply voltage	VDD	2.3		3.6	V
Power supply current, stand-by mode (VDD = 3.0 V)	IDD _{STBY}		2.8	5	μA
Power supply average current, ALS1 operating 100 ms integration time and 500 ms intervals	IDD _{ALS1}			50	μA
Power supply average current, ALS2 operating 100 ms integration time and 500 ms intervals	IDD _{ALS2}			50	μA
Power supply average current, PS operating 300 μs integration time and 100 ms intervals	IDD _{PS}		47	100	μA
LED average sink current, PS operating at 300 μs integration time and 100 ms intervals and LED current set at 50 mA	I _{LED}		75		μA
I ² C signal voltage (Note 3)	VDD_I2C	1.6	1.8	2.0	V
Low level input voltage (VDD_I2C related input levels)	V _{IL}	-0.3		0.3 VDD_I2C	V
High level input voltage (VDD_I2C related input levels)	V _{IH}	0.7 VDD_I2C		VDD_I2C + 0.2	V
Hysteresis of Schmitt trigger inputs	V _{hys}	0.1 VDD_I2C			V
Low level output voltage (open drain) at 3 mA sink current (INT)	V _{OL}			0.2 VDD_I2C	V
Input current of IO pin with an input voltage between 0.1 VDD and 0.9 VDD	I _I	-10		10	μA
Output low current (INT)	I _{OL}	3		-	mA
Operating free-air temperature range	T _A	-40		80	°C

3. The I²C interface is functional to 3.0 V, but timing is only guaranteed up to 2.0 V. High Speed mode is guaranteed to be functional to 2.0 V.

NOA3315

Table 4. ELECTRICAL CHARACTERISTICS (Unless otherwise specified, these specifications apply over 2.3 V < VDD < 3.6 V, 1.7 V < VDD_I2C < 1.9 V, -40°C < T_A < 80°C, 10 pF < C_b < 100 pF) (See Note 4)

Parameter	Symbol	Min	Typ	Max	Unit
LED pulse current	I _{LED_pulse}	10		160	mA
LED pulse current step size	I _{LED_pulse_step}		5		mA
LED pulse current accuracy	I _{LED_acc}	-20		+20	%
Interval Timer Tolerance	Tol _{f_timer}	-35		+35	%
Edge Triggered Interrupt Pulse Width	PW _{INT}		50		μS
SCL clock frequency	f _{SCL_std}	10		100	kHz
	f _{SCL_fast}	100		400	
	f _{SCL_hs}	100		3400	
Hold time for START condition. After this period, the first clock pulse is generated.	T _{HD;STA_std}	4.0		-	μS
	t _{HD;STA_fast}	0.6		-	
	t _{HD;STA_hs}	0.160		-	
Low period of SCL clock	t _{LOW_std}	4.7		-	μS
	t _{LOW_fast}	1.3		-	
	t _{LOW_hs}	0.160		-	
High period of SCL clock	t _{HIGH_std}	4.0		-	μS
	t _{HIGH_fast}	0.6		-	
	t _{HIGH_hs}	0.060		-	
SDA Data hold time	t _{HD;DAT_d_std}	0		3.45	μS
	t _{HD;DAT_d_fast}	0		0.9	
	t _{HD;DAT_d_hs}	0		0.070	
SDA Data set-up time	t _{SU;DAT_std}	250		-	nS
	t _{SU;DAT_fast}	100		-	
	t _{SU;DAT_hs}	10		-	
Rise time of both SDA and SCL (input signals) (Note 5)	t _{r_INPUT_std}	20		1000	nS
	t _{r_INPUT_fast}	20		300	
	t _{r_INPUT_hs}	10		40	
Fall time of both SDA and SCL (input signals) (Note 5)	t _{f_INPUT_std}	20		300	nS
	t _{f_INPUT_fast}	20		300	
	t _{f_INPUT_hs}	10		40	
Rise time of SDA output signal (Note 5)	t _{r_OUT_std}	20		300	nS
	t _{r_OUT_fast}	20 + 0.1 C _b		300	
	t _{r_OUT_hs}	10		80	
Fall time of SDA output signal (Note 5)	t _{f_OUT_std}	20		300	nS
	t _{f_OUT_fast}	20 + 0.1 C _b		300	
	t _{f_OUT_hs}	10		80	
Set-up time for STOP condition	t _{SU;STO_std}	4.0		-	μS
	t _{SU;STO_fast}	0.6		-	
	t _{SU;STO_hs}	0.160		-	
Bus free time between STOP and START condition	t _{BUF_std}	4.7		-	μS
	t _{BUF_fast}	1.3		-	
	t _{BUF_hs}	0.160		-	

NOA3315

Table 4. ELECTRICAL CHARACTERISTICS (Unless otherwise specified, these specifications apply over 2.3 V < VDD < 3.6 V, 1.7 V < VDD_I2C < 1.9 V, -40°C < T_A < 80°C, 10 pF < C_b < 100 pF) (See Note 4)

Parameter	Symbol	Min	Typ	Max	Unit
Capacitive load for each bus line (including all parasitic capacitance) (Note 6)	C _b	10		100	pF
Noise margin at the low level (for each connected device – including hysteresis)	V _{nL}	0.1 VDD		–	V
Noise margin at the high level (for each connected device – including hysteresis)	V _{nH}	0.2 VDD		–	V

- Refer to Figure 2 and Figure 3 for more information on AC characteristics.
- The rise time and fall time are dependent on both the bus capacitance (C_b) and the bus pull-up resistor R_p. Max and min pull-up resistor values are determined as follows: R_{p(max)} = t_{r(max)} / (0.8473 x C_b) and R_{p(min)} = (V_{dd_I2C} - V_{ol(max)}) / I_{ol}.
- C_b = capacitance of one bus line, maximum value of which including all parasitic capacitances should be less than 100 pF. Bus capacitance up to 400 pF is supported, but at relaxed timing.

Table 5. OPTICAL CHARACTERISTICS (Unless otherwise specified, these specifications are for VDD = 3.0 V, T_A = 25°C)

Parameter	Symbol	Min	Typ	Max	Unit
AMBIENT LIGHT SENSOR 1					
Spectral response, peak (Note 7)	λ _p		560		nm
Spectral response, low -3 dB	λ _{c_low}		510		nm
Spectral response, high -3 dB	λ _{c_high}		610		nm
Dynamic range	DR _{ALS}	0.02		52k	lux
Maximum Illumination (ALS operational but saturated)	E _{v_MAX}			120k	lux
Resolution, Counts per lux, T _{int} = 400 ms, Range = 0 (100 counts/lux)	CR ₄₀₀		800		counts
Resolution, Counts per lux, T _{int} = 100 ms, Range = 0 (100 counts/lux)	CR ₁₀₀		200		counts
Resolution, Counts per lux, T _{int} = 50 ms, Range = 0 (100 counts/lux)	CR ₅₀		100		counts
Illuminance responsivity, green 560 nm LED, E _v = 10 lux, T _{int} = 50 ms, Range = 0 (100 counts/lux)	R _{v_g10}		1000		counts
Illuminance responsivity, green 560 nm LED, E _v = 100 lux, T _{int} = 50 ms, Range = 0 (100 counts/lux)	R _{v_g100}		10000		counts
Dark current, E _v = 0 lux, T _{int} = 100 ms	R _{vd}	0	0	3	counts

PROXIMITY SENSOR (Note 8)

Detection range, T _{int} = 4800 μs, I _{LED} = 160 mA, 860 nm IR LED (OS-RAM SFH4650), White Reflector (RGB = 220, 224, 223), LED Modulation Frequency = 308 kHz, Sample Delay = 250 ns, SNR = 7:1	D _{PS_4800_WHITE_MOD}		200		mm
Detection range, T _{int} = 4800 μs, I _{LED} = 160 mA, 860 nm IR LED (OS-RAM SFH4650), White Reflector (RGB = 220, 224, 223), SNR = 8:1	D _{PS_4800_WHITE_160}		148		mm
Detection range, T _{int} = 4800 μs, I _{LED} = 25 mA, 860 nm IR LED (OS-RAM SFH4650), White Reflector (RGB = 220, 224, 223), SNR = 8:1	D _{PS_4800_WHITE_25}		66		mm
Detection range, T _{int} = 2400 μs, I _{LED} = 50 mA, 860 nm IR LED (OS-RAM SFH4650), White Reflector (RGB = 220, 224, 223), SNR = 8:1	D _{PS_2400_WHITE_25}		80		mm
Detection range, T _{int} = 1800 μs, I _{LED} = 75 mA, 860 nm IR LED (OS-RAM SFH4650), White Reflector (RGB = 220, 224, 223), SNR = 8:1	D _{PS_1800_WHITE_75}		88		mm
Detection range, T _{int} = 1200 μs, I _{LED} = 100 mA, 860 nm IR LED (OS-RAM SFH4650), White Reflector (RGB = 220, 224, 223), SNR = 8:1	D _{PS_1200_WHITE_100}		90		mm
Detection range, T _{int} = 600 μs, I _{LED} = 125 mA, 860 nm IR LED (OS-RAM SFH4650), White Reflector (RGB = 220, 224, 223), SNR = 8:1	D _{PS_600_WHITE_125}		88		mm
Detection range, T _{int} = 600 μs, I _{LED} = 100 mA, 860 nm IR LED (OS-RAM SFH4650), White Reflector (RGB = 220, 224, 223), SNR = 8:1	D _{PS_600_WHITE_100}		76		mm

- Refer to Figure 4 for more information on spectral response.
- Measurements performed with default modulation frequency and sample delay unless noted.

NOA3315

Table 5. OPTICAL CHARACTERISTICS (Unless otherwise specified, these specifications are for VDD = 3.0 V, T_A = 25°C)

Parameter	Symbol	Min	Typ	Max	Unit
PROXIMITY SENSOR (Note 8)					
Detection range, T _{int} = 300 μs, I _{LED} = 150 mA, 860 nm IR LED (OS-RAM SFH4650), White Reflector (RGB = 220, 224, 223), SNR = 8:1	D _{PS_300_WHITE_150}		74		mm
Detection range, T _{int} = 300 μs, I _{LED} = 100 mA, 860 nm IR LED (OS-RAM SFH4650), White Reflector (RGB = 220, 224, 223), SNR = 8:1	D _{PS_300_WHITE_100}		62		mm
Detection range, T _{int} = 150 μs, I _{LED} = 100 mA, 860 nm IR LED (OS-RAM SFH4650), White Reflector (RGB = 220, 224, 223), SNR = 8:1	D _{PS_150_WHITE_100}		48		mm
Detection range, T _{int} = 1200 μs, I _{LED} = 100 mA, 860 nm IR LED (OS-RAM SFH4650), Grey Reflector (RGB = 162, 162, 160), SNR = 6:1	D _{PS_1200_GREY_100}		64		mm
Detection range, T _{int} = 2400 μs, I _{LED} = 150 mA, 860 nm IR LED (OS-RAM SFH4650), Black Reflector (RGB = 16, 16, 15), SNR = 6:1	D _{PS_2400_BLACK_150}		36		mm
Saturation power level	P _{DMAX}		0.8		mW/cm ²
Measurement resolution, T _{int} = 150 μs	MR ₁₅₀		11		bits
Measurement resolution, T _{int} = 300 μs	MR ₃₀₀		12		bits
Measurement resolution, T _{int} = 600 μs	MR ₆₀₀		13		bits
Measurement resolution, T _{int} = 1200 μs	MR ₁₂₀₀		14		bits
Measurement resolution, T _{int} = 1800 μs	MR ₁₈₀₀		15		bits
Measurement resolution, T _{int} = 2400 μs	MR ₂₄₀₀		15		bits
Measurement resolution, T _{int} = 3600 μs	MR ₃₆₀₀		16		bits
Measurement resolution, T _{int} = 4800 μs	MR ₄₈₀₀		16		bits

7. Refer to Figure 4 for more information on spectral response.

8. Measurements performed with default modulation frequency and sample delay unless noted.

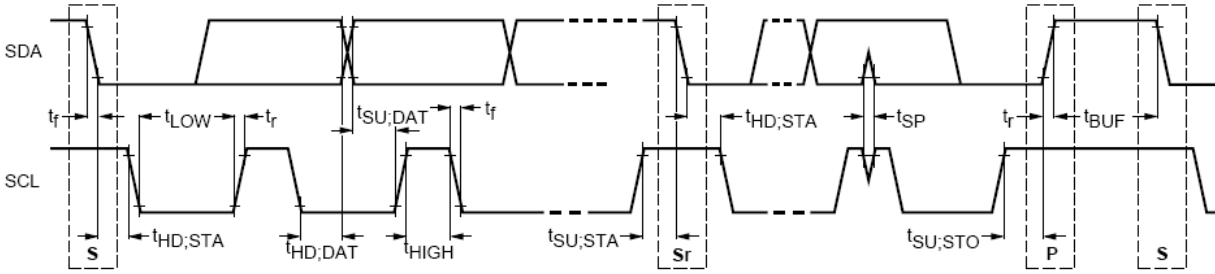

Figure 2. AC Characteristics, Standard and Fast Modes

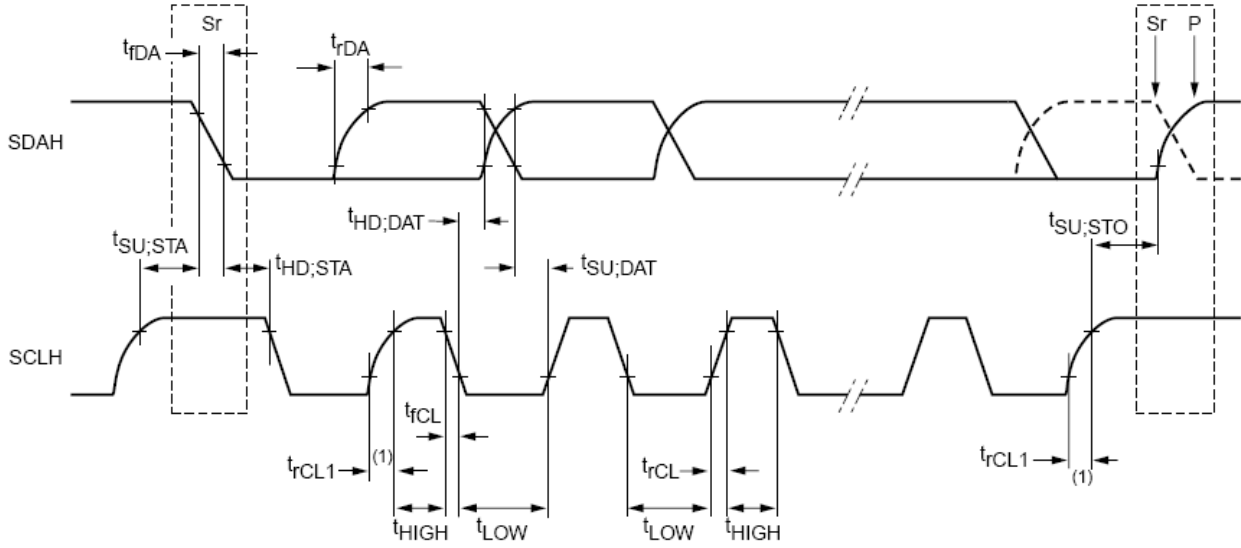

Figure 3. AC Characteristics, High Speed Mode

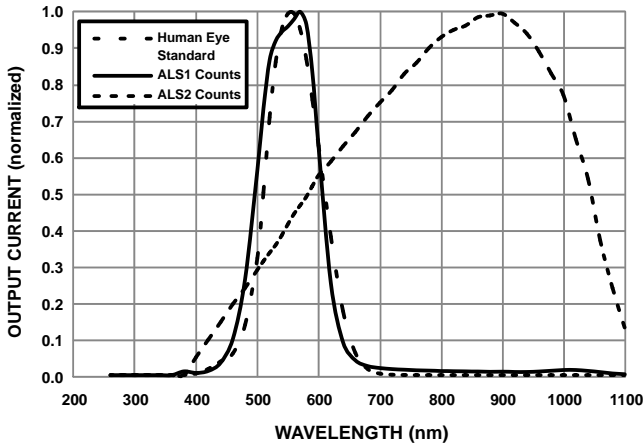

Figure 4. ALS Spectral Response (Normalized)

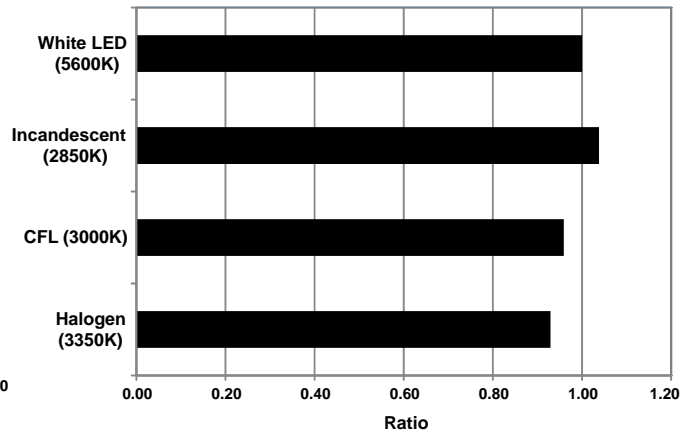

Figure 5. ALS1 Light Source Dependency (Normalized to White LED Light)

TYPICAL CHARACTERISTICS

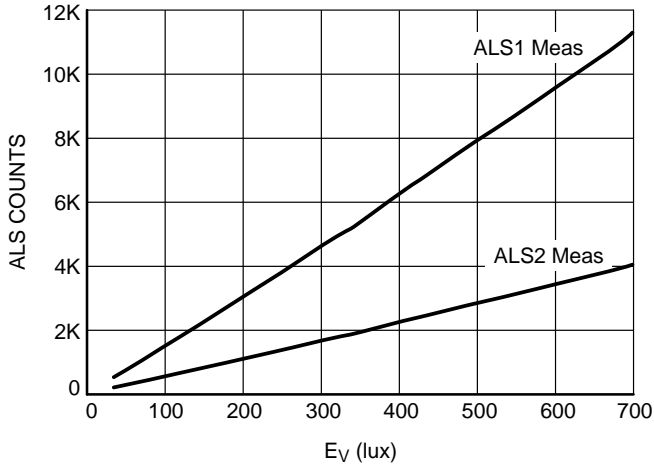

Figure 6. ALS1 Linearity 0-700 lux

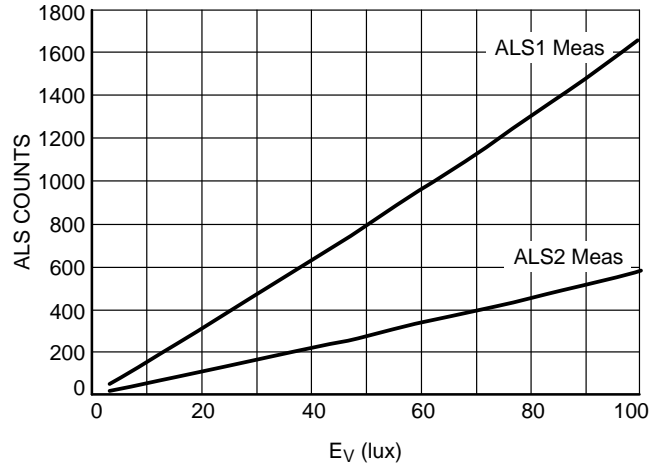

Figure 7. ALS1 Linearity 0-100 lux

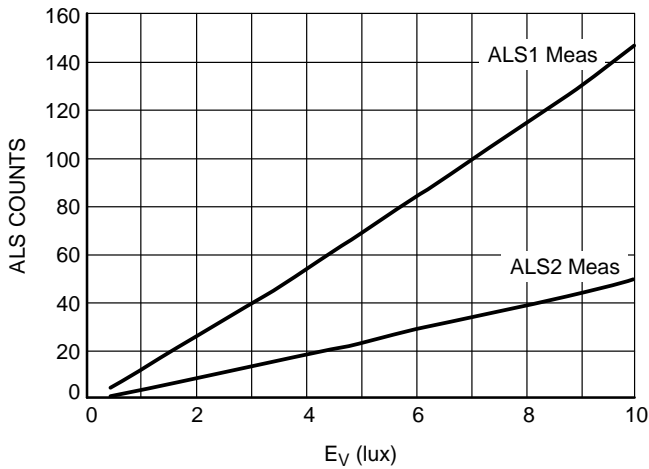

Figure 8. ALS1 Linearity 0-10 lux

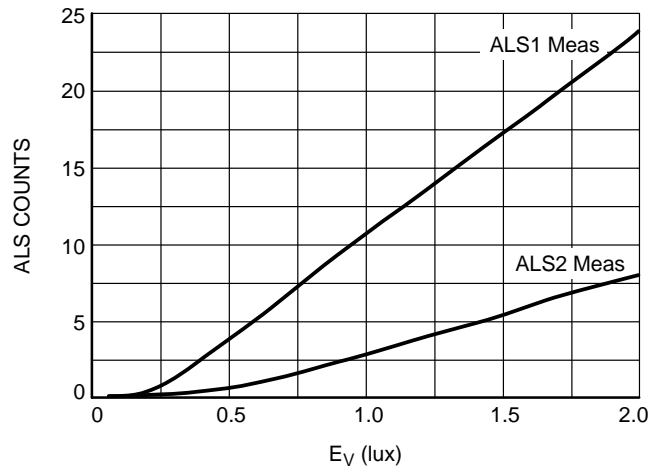

Figure 9. ALS1 Linearity 0-2 lux

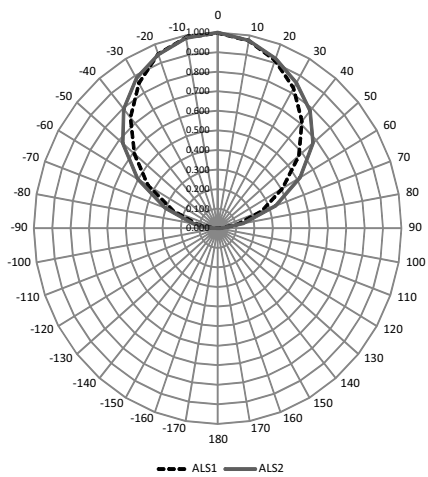

Figure 10. ALS1 & ALS2 Horizontal Response to White LED Light vs Angle (Source swept from LED pin (+90°) to VDD pin (-90°))

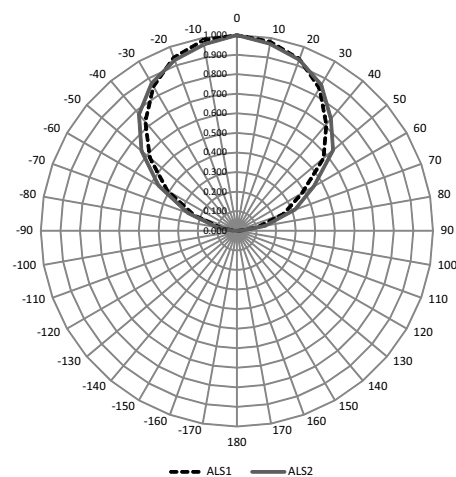

Figure 11. ALS1 & ALS2 Vertical Response to White LED Light vs Angle (Source swept from LED pin (+90°) to INT pin (-90°))

TYPICAL CHARACTERISTICS

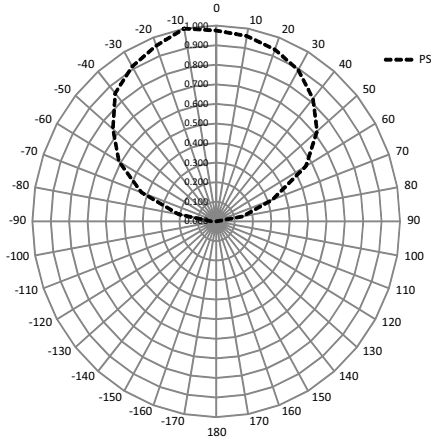

Figure 12. PS Horizontal Response to IR LED Light vs Angle (Source swept from LED pin (+90°) to VDD pin (-90°))

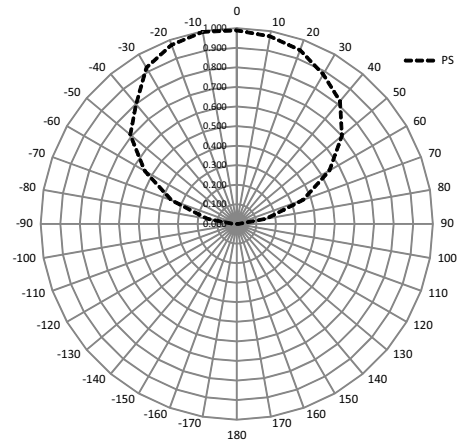

Figure 13. PS Vertical Response to IR LED Light vs Angle (Source swept from LED pin (+90°) to INT pin (-90°))

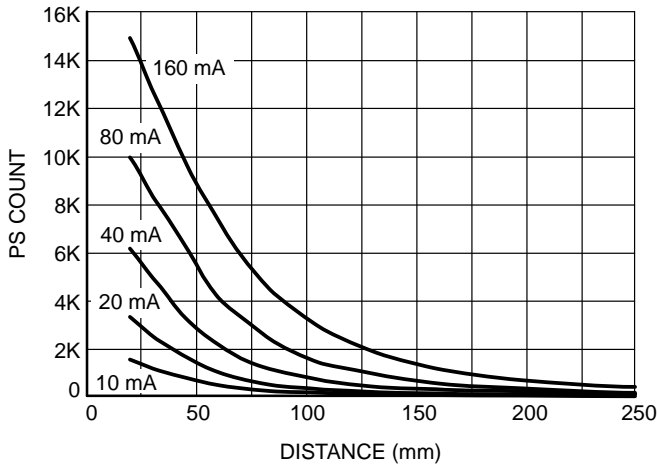

Figure 14. PS Response vs. Distance and LED Current (1200 μ s Integration Time, White Reflector (RGB = 220, 224, 223))

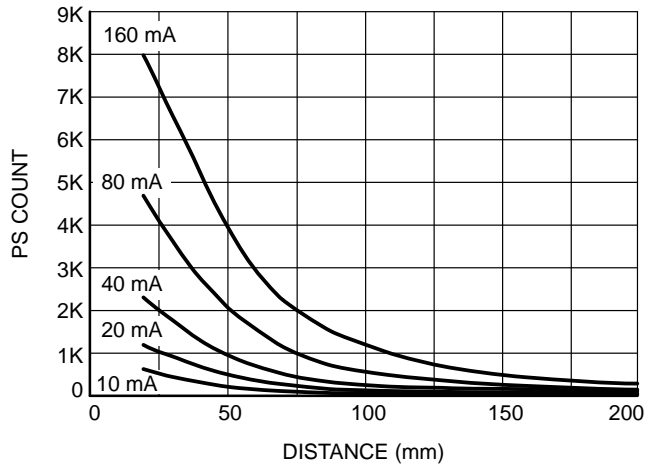

Figure 15. PS Response vs. Distance and LED Current (1200 μ s Integration Time, Grey Reflector (RGB = 162, 162, 160))

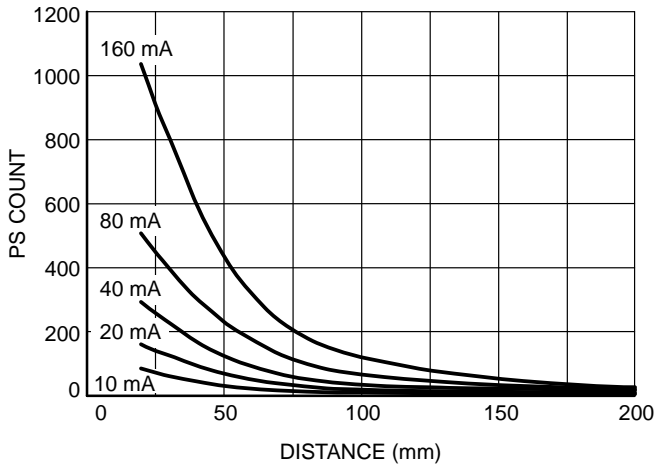

Figure 16. PS Response vs. Distance and LED Current (1200 μ s Integration Time, Black Reflector (RGB = 16, 16, 15))

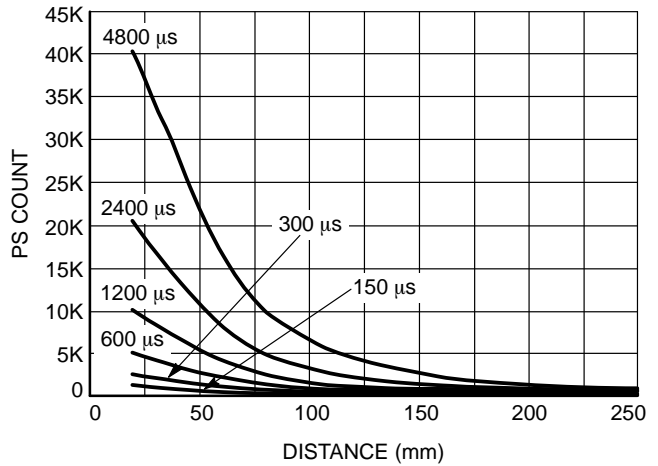

Figure 17. PS Response vs. Distance and Integration Time (80 mA LED Current, White Reflector (RGB = 220, 224, 223))

TYPICAL CHARACTERISTICS

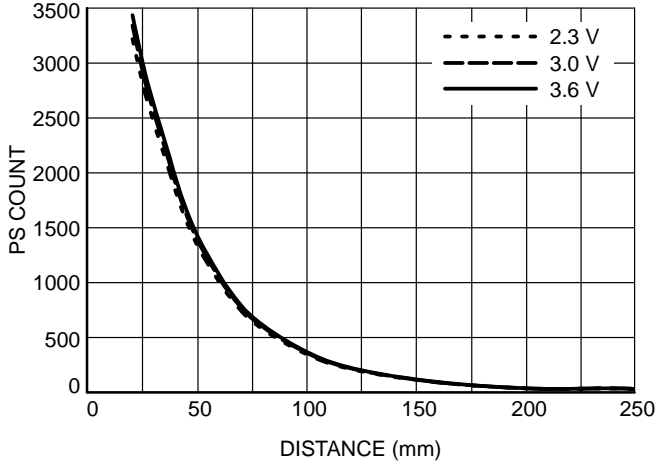

Figure 18. PS Response vs. Distance and Supply Voltage (1200 μ s Integration Time, 40 mA LED Current, White Reflector (RGB = 220, 224, 223))

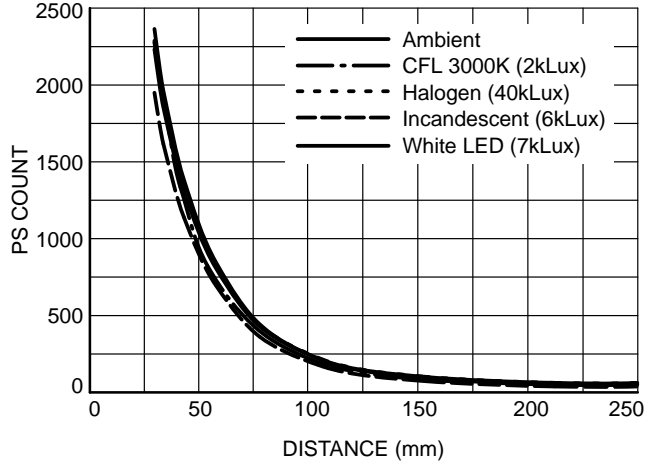

Figure 19. PS Ambient Rejection (1200 μ s Integration Time, 100 mA LED Current, White Reflector (RGB = 220, 224, 223))

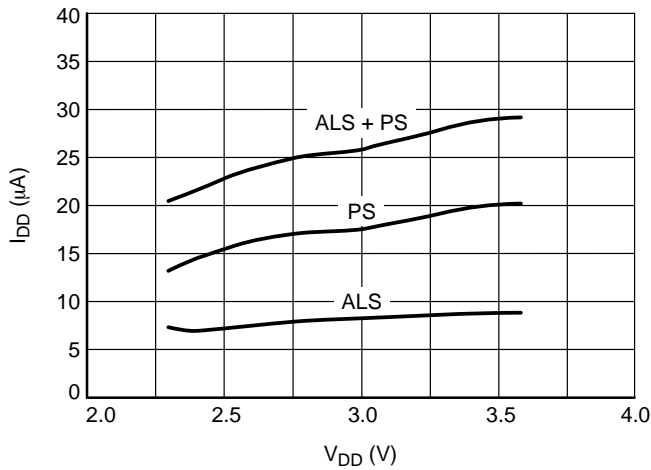

Figure 20. Supply Current vs. Supply Voltage
ALS1 or ALS2 TINT = 100 ms, TR = 500 ms PS
TINT = 300 μ s, TR = 100 ms

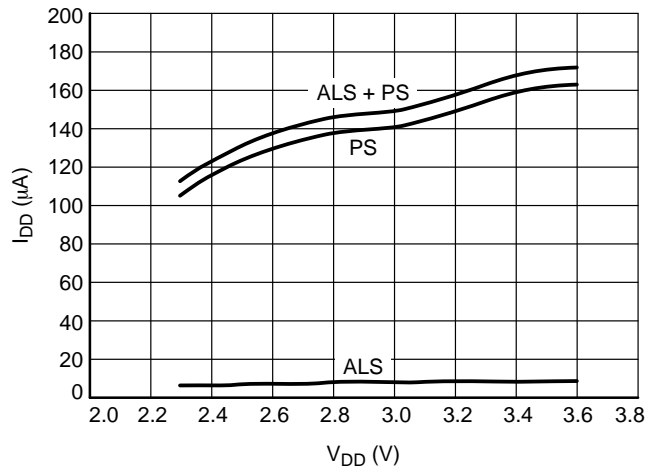

Figure 21. Supply Current vs. Supply Voltage
ALS1 and ALS2 TINT = 100 ms, TR = 500 ms
PS TINT = 1200 μ s, TR = 50 ms

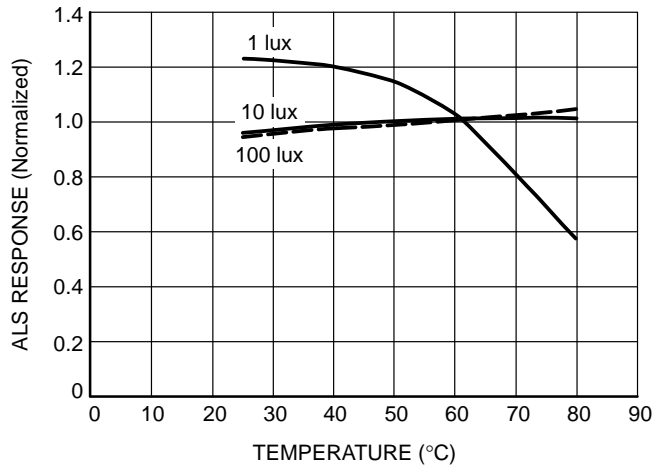

Figure 22. ALS1 Response vs. Temperature

Description of Operation

Proximity Sensor Architecture

NOA3315 combines an advanced digital proximity sensor, LED driver, dual ambient light sensors and a tri-mode I²C interface as shown in Figure 1. The LED driver draws a modulated current through the external IR LED to illuminate the target. The LED current is programmable over a wide range. The infrared light reflected from the target is detected by the proximity sensor photo diode. The proximity sensor employs a sensitive photo diode fabricated in ON Semiconductor's standard CMOS process technology. The modulated light received by the on-chip photodiode is converted to a digital signal using a variable slope integrating ADC with a default resolution (at 300 μs) of 12-bits, unsigned. The signal is processed to remove all unwanted signals resulting in a highly selective response to the generated light signal. The final value is stored in the PS_DATA register where it can be read by the I²C interface.

Proximity Sensor LED Frequency and Delay Settings

The LED current modulation frequency is user selectable from approximately 128 KHz to 2 MHz using the PS_LED_FREQUENCY register. An internal precision 4 MHz oscillator provides the frequency reference. The 4 MHz clock is divided by the value in register 0x0D to

determine the pulse rate. The default is 0x10 (16) which results in an LED pulse frequency of 250 KHz (4 μs period). Values below 200 KHz and above 1 MHz are not recommended.

Switching high LED currents can result in noise injected into the proximity sensor receiver causing inaccurate readings. The PS receiver has a user programmable delay from the LED edge to when the receiver samples the data (PS_SAMPLE_DELAY – register 0x0E). Longer delays may reduce the effect of switching noise but also reduce the sensitivity.

Since the value of the delay is dependent on the pulse frequency, its value must be carefully computed. The value obviously cannot exceed the LED pulse width or there would be no sampling of the data when the LED is illuminated. There is also a minimum step size of 125 ns.

The delay values are programmed as follows:

0 or 1: No delay

2–31: Selects (N–1)*125 ns

N must be less than or equal to the

PS_LED_FREQUENCY Value

The default delay is 0x05 (500 ns)

Table 6 shows some common LED pulse frequencies and sample delays and the resulting register values.

Table 6. COMMON LED PULSE FREQUENCY SETTINGS

LED Pulse Frequency (KHz)	Sample Delay (ns)	PS_LED_FREQUENCY Register (0x0D) Value	PS_SAMPLE_DELAY Register (0x0E) Value
200	250	0x14	0x03
200	500	0x14	0x05
200	750	0x14	0x07
250	250	0x10	0x03
250	500	0x10	0x05
500	250	0x08	0x03
500	500	0x08	0x05
1000	250	0x04	0x03

Ambient Light Sensor Architecture

The NOA3315 contains two ambient light sensors. The first ambient light sensor employs a photo diode with its own proprietary photopic filter limiting extraneous photons, and thus performing as a band pass filter on the incident wave front. The filter only transmits photons in the visible spectrum which are primarily detected by the human eye. The photo response of this sensor is as shown in Figure 4. The second ambient light sensor employs a similar photo diode but without a light filter. Either or both ALS can be enabled. When disabled, an ALS is put in power down mode.

The ambient light signal detected by each photo diode is converted to a digital signal using a variable slope integrating ADC with a resolution of 16-bits, unsigned. The ADC values are stored in the ALS1_DATA and ALS2_DATA registers where they can be read by the I²C interface.

Equation 1 shows the relationship of output counts C_{nt} as a function of integration constant I_k , integration time T_{int} (in seconds) and the intensity of the ambient light, I_L (in lux), at room temperature (25°C) for ALS1.

$$I_L = \frac{C_{nt}}{(I_k \cdot T_{int})} \quad (\text{eq. 1})$$

Where:

$I_k = 1920$ counts/lux*s (for fluorescent light)

$I_k = 2080$ counts/lux*s (for incandescent light)

Hence the intensity of the ambient fluorescent light (in lux):

$$I_L = \frac{C_{nt}}{(1920 \cdot T_{int})} \quad (\text{eq. 2})$$

and the intensity of the ambient incandescent light (in lux):

$$I_L = \frac{C_{nt}}{(2080 \cdot T_{int})} \quad (\text{eq. 3})$$

For example let:

$$C_{nt} = 2000 \text{ counts}$$

$$T_{int} = 50 \text{ ms}$$

Intensity of ambient fluorescent light, I_L (in lux):

$$I_L = \frac{2000}{(1920 \cdot 50 \text{ ms})} \quad (\text{eq. 4})$$

$$I_L = 20.83 \text{ lux}$$

ALS Spectral Response Correction

The ALS1 photopic filter has some IR leakage which results in higher ALS readings for light sources with higher IR content, such as incandescent lighting. For purely photopic light, ALS1 is very accurate and correction is not needed. For other light sources, or if the spectral response of the light is shifted by cover glass, etc., the ALS reading can be corrected by reading both ALS1 and ALS2 and applying an equation such as

$$ALS = ALS1 \cdot \left(0.1 \cdot \left(\frac{ALS1}{ALS2} \right) + 0.5 \right)$$

The equation shown does not work well for very low ALS1 and/or ALS2 values (a single count introduces a large correction factor), thus it is recommended that the correction not be applied if the ALS1 value is below 5 counts and/or the ALS2 value is 0. Likewise if ALS1 reaches 65535 counts, the equation will begin to be incorrect and thus should not be applied. To provide the best possible correction, the equation will change based on the spectral characteristics of the glass used between the sensor and the light source. The equation shown was chosen to provide the best fit of a number of different light sources with no filter glass used.

I²C Interface

The NOA3315 acts as an I²C slave device and supports single register and block register read and write operations. All data transactions on the bus are 8 bits long. Each data byte transmitted is followed by an acknowledge bit. Data is transmitted with the MSB first.

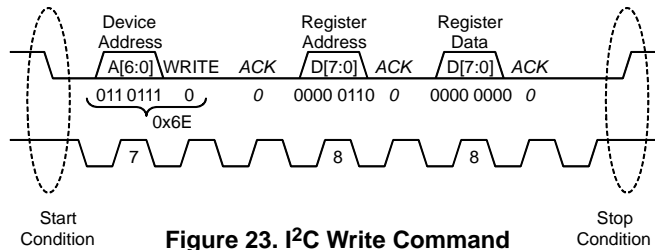

Figure 23. I²C Write Command

Figure 23 shows an I²C write operation. Write transactions begin with the master sending an I²C start sequence followed by the seven bit slave address (NOA3315 = 0x37) and the write(0) command bit. The NOA3315 will acknowledge this byte transfer with an appropriate ACK. Next the master will send the 8 bit register address to be written to. Again the NOA3315 will acknowledge reception with an ACK. Finally, the master will begin sending 8 bit data segment(s) to be written to the NOA3315 register bank.

The NOA3315 will send an ACK after each byte and increment the address pointer by one in preparation for the next transfer. Write transactions are terminated with either an I²C STOP or with another I²C START (repeated START).

Figure 24 shows an I²C read command sent by the master to the slave device. Read transactions begin in much the same manner as the write transactions in that the slave address must be sent with a write(0) command bit.

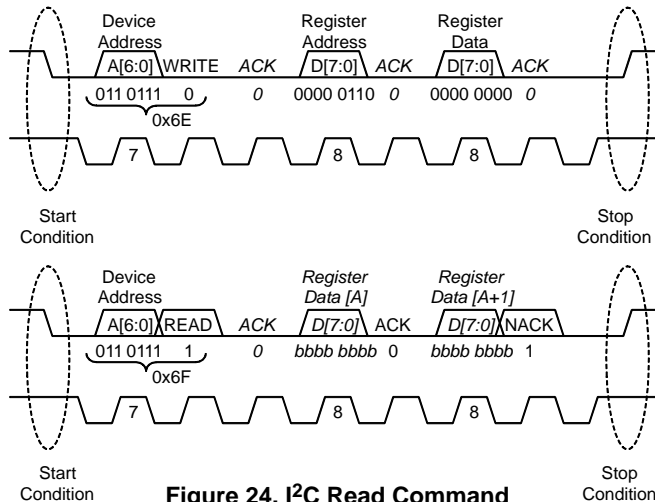

Figure 24. I²C Read Command

NOA3315

After the NOA3315 sends an ACK, the master sends the register address as if it were going to be written to. The NOA3315 will acknowledge this as well. Next, instead of sending data as in a write, the master will re-issue an I²C START (repeated start) and again send the slave address and this time the read(1) command bit. The NOA3315 will then begin shifting out data from the register just addressed. If the master wishes to receive more data (next register address), it will ACK the slave at the end of the 8 bit data transmission, and the slave will respond by sending the next byte, and so on. To signal the end of the read transaction, the master will send a NACK bit at the end of a transmission followed by an I²C STOP.

The NOA3315 also supports I²C high-speed mode. The transition from standard or fast mode to high-speed mode is initiated by the I²C master. A special reserve device address is called for and any device that recognizes this and supports high speed mode immediately changes the performance

characteristics of its I/O cells in preparation for I²C transactions at the I²C high speed data protocol rates. From then on, standard I²C commands may be issued by the master, including repeated START commands. When the I²C master terminates any I²C transaction with a STOP sequence, the master and all slave devices immediately revert back to standard/fast mode I/O performance.

By using a combination of high-speed mode and a block write operation, it is possible to quickly initialize the NOA3315 I²C register bank.

NOA3315 Data Registers

NOA3315 operation is observed and controlled by internal data registers read from and written to via the external I²C interface. Registers are listed in Table 7. Default values are set on initial power up or via a software reset command (register 0x01).

The I²C Slave Address of the NOA3315 is 0x37.

Table 7. NOA3315 Data Registers

Address	Type	Name	Description
0x00	R	PART_ID	NOA3315 part number and revision IDs
0x01	RW	RESET	Software reset control
0x02	RW	INT_CONFIG	Interrupt pin functional control settings
0x0D	RW	PS_LED_FREQUENCY	PS LED Pulse Frequency
0x0E	RW	PS_SAMPLE_DELAY	PS Sample Delay
0x0F	RW	PS_LED_CURRENT	PS LED pulse current
0x10	RW	PS_TH_UP_MSB	PS Interrupt upper threshold, most significant bits
0x11	RW	PS_TH_UP_LSB	PS Interrupt upper threshold, least significant bits
0x12	RW	PS_TH_LO_MSB	PS Interrupt lower threshold, most significant bits
0x13	RW	PS_TH_LO_LSB	PS Interrupt lower threshold, least significant bits
0x14	RW	PS_FILTER_CONFIG	PS Interrupt Filter configuration
0x15	RW	PS_CONFIG	PS Integration time configuration
0x16	RW	PS_INTERVAL	PS Interval time configuration
0x17	RW	PS_CONTROL	PS Operation mode control
0x20	RW	ALS_TH_UP_MSB	ALS Interrupt upper threshold, most significant bits
0x21	RW	ALS_TH_UP_LSB	ALS Interrupt upper threshold, least significant bits
0x22	RW	ALS_TH_LO_MSB	ALS Interrupt lower threshold, most significant bits
0x23	RW	ALS_TH_LO_LSB	ALS Interrupt lower threshold, least significant bits
0x24	RW	ALS_FILTER_CONFIG	ALS Interrupt Filter Configuration
0x25	RW	ALS_CONFIG	ALS Integration time configuration
0x26	RW	ALS_INTERVAL	ALS Interval time configuration
0x27	RW	ALS_CONTROL	ALS Operation mode control
0x40	R	INTERRUPT	Interrupt status
0x41	R	PS_DATA_MSB	PS measurement data, most significant bits
0x42	R	PS_DATA_LSB	PS measurement data, least significant bits
0x43	R	ALS1_DATA_MSB	ALS1 measurement data, most significant bits
0x44	R	ALS1_DATA_LSB	ALS1 measurement data, least significant bits
0x45	R	ALS2_DATA_MSB	ALS2 measurement data, most significant bits
0x46	R	ALS2_DATA_LSB	ALS2 measurement data, least significant bits

NOA3315

PART_ID Register (0x00)

The PART_ID register provides part and revision identification. These values are hard-wired at the factory and cannot be modified.

Table 8. PART_ID Register (0x00)

Bit	7	6	5	4	3	2	1	0
Field	Part number ID				Revision ID			

Field	Bit	Default	Description
Part number ID	7:4	1011	Part number identification
Revision ID	3:0	NA	Silicon revision number

RESET Register (0x01)

Software reset is controlled by this register. Setting this register followed by an I2C_STOP sequence will immediately reset the NOA3315 to the default startup

standby state. Triggering the software reset has virtually the same effect as cycling the power supply tripping the internal Power on Reset (POR) circuitry.

Table 9. RESET Register (0x01)

Bit	7	6	5	4	3	2	1	0
Field	NA							SW_reset

Field	Bit	Default	Description
NA	7:1	XXXXXXXX	Don't care
SW_reset	0	0	Software reset to startup state

INT_CONFIG Register (0x02)

INT_CONFIG register controls the external interrupt pin function.

Table 10. INT_CONFIG Register (0x02)

Bit	7	6	5	4	3	2	1	0
Field	NA					edge_triggered	auto_clear	polarity

Field	Bit	Default	Description	
NA	7:3	XXXXX	Don't care	
Edge_triggered	2	0	0	Interrupt pin stays asserted while the INTERRUPT register bit is set (level)
			1	Interrupt pin pulses at the end of each measurement while the INTERRUPT register bit is set
auto_clear	1	1	0	When an interrupt is triggered, the interrupt pin remains asserted until cleared by an I ² C read of INTERRUPT register
			1	Interrupt pin state is updated after each measurement
polarity	0	0	0	Interrupt pin active low when asserted
			1	Interrupt pin active high when asserted

PS_LED_FREQUENCY Register (0x0D)

The LED FREQUENCY register controls the frequency of the LED pulses. The LED modulation frequency is determined by dividing 4 MHz by the register value. Valid

divisors are 2–31. The default value is 16 which results in an LED pulse frequency of 250 KHz (one pulse every 4 μs).

Table 11. PS_LED_FREQUENCY Register (0x0D)

Bit	7	6	5	4	3	2	1	0
Field	NA			LED_Modulation Frequency				

Field	Bit	Default	Description
NA	7:5	XXX	Don't care
LED_Frequency	4:0	10000	Defines the divider of the 4MHz clock to generate the LED pulses. Valid values are 2–31.

PS_SAMPLE_DELAY Register (0x0E)

The PS_SAMPLE_DELAY register controls the time delay after an LED pulse edge before the resulting signal is sampled by the proximity sensor. This can be used to reduce the effect of noise caused by the LED current switching. There is no delay for programmed values of 0x00 or 0x001. For other values the delay is $(N-1)*125ns$, where N is the

decimal value of the register. Default value is 0x05 (500ns). N must be less than or equal to the value in register 0x0D (PS_LED_FREQUENCY). See the Description of Operation section for more information on programming this register.

Table 12. PS_SAMPLE_DELAY Register (0x0E)

Bit	7	6	5	4	3	2	1	0
Field	NA			PS_Sample_Delay				

Field	Bit	Default	Description
NA	7:5	XXX	Don't care
Sample Delay	4:0	00101	Defines the delay from the LED pulse edge before the pulse is sampled.

PS_LED_CURRENT Register (0x0F)

The LED_CURRENT register controls how much current the internal LED driver sinks through the IR LED during modulated illumination. The current sink range is 5 mA plus a binary weighted value of the LED_Current register times

5 mA, for an effective range of 10 mA to 160 mA in steps of 5 mA. The default setting is 50 mA. A register setting of 00 turns off the LED Driver.

Table 13. PS_LED_CURRENT Register (0x0F)

Bit	7	6	5	4	3	2	1	0
Field	NA			LED_Current				

Field	Bit	Default	Description
NA	7:5	XXX	Don't care
LED_Current	4:0	01001	Defines current sink during LED modulation. Binary weighted value times 5 mA plus 5 mA.

PS_TH Registers (0x10 – 0x13)

With hysteresis not enabled (see PS_CONFIG register), the PS_TH registers set the upper and lower interrupt thresholds of the proximity detection window. Interrupt functions compare these threshold values to data from the PS_DATA registers. Measured PS_DATA values outside this window will set an interrupt according to the INT_CONFIG register settings.

threshold hysteresis value where the interrupt would be cleared. Setting the PS_hyst_trig low reverses the function such that the PS_TH_LO register sets the lower threshold at which an interrupt will be set and the PS_TH_UP represents the hysteresis value at which the interrupt would be subsequently cleared. Hysteresis functions only apply in “auto_clear” INT_CONFIG mode.

With hysteresis enabled, threshold settings take on a different meaning. If PS_hyst_trig is set, the PS_TH_UP register sets the upper threshold at which an interrupt will be set, while the PS_TH_LO register then sets the lower

The controller software must ensure the settings for LED current, sensitivity range, and integration time (LED pulses) are appropriate for selected thresholds. Setting thresholds to extremes (default) effectively disables interrupts.

Table 14. PS_TH_UP Registers (0x10 – 0x11)

Bit	7	6	5	4	3	2	1	0
Field	PS_TH_UP_MSB(0x10), PS_TH_UP_LSB(0x11)							
Field	Bit	Default	Description					
PS_TH_UP_MSB	7:0	0xFF	Upper threshold for proximity detection, MSB					
PS_TH_UP_LSB	7:0	0xFF	Upper threshold for proximity detection, LSB					

Table 15. PS_TH_LO Registers (0x12 – 0x13)

Bit	7	6	5	4	3	2	1	0
Field	PS_TH_LO_MSB(0x12), PS_TH_LO_LSB(0x13)							
Field	Bit	Default	Description					
PS_TH_LO_MSB	7:0	0x00	Lower threshold for proximity detection, MSB					
PS_TH_LO_LSB	7:0	0x00	Lower threshold for proximity detection, LSB					

PS_FILTER_CONFIG Register (0x14)

PS_FILTER_CONFIG register provides a hardware mechanism to filter out single event occurrences or similar anomalies from causing unwanted interrupts. Two 4 bit registers (M and N) can be set with values such that M out of N measurements must exceed threshold settings in order

to set an interrupt. The default setting of 1 out of 1 effectively turns the filter off and any single measurement exceeding thresholds can trigger an interrupt. N must be greater than or equal to M. A setting of 0 for either M or N is not allowed and disables the PS Interrupt.

Table 16. PS_FILTER_CONFIG Register (0x14)

Bit	7	6	5	4	3	2	1	0
Field	filter_N				filter_M			
Field	Bit	Default	Description					
filter_N	7:4	0001	Filter N					
filter_M	3:0	0001	Filter M					

PS_CONFIG Register (0x15)

Proximity measurement sensitivity is controlled by specifying the integration time. The integration time sets the number of LED pulses during the modulated illumination. The LED modulation frequency remains constant with a period of 1.5 μ s. Changing the integration time affects the sensitivity of the detector and directly affects the power consumed by the LED. The default is 1200 μ s integration period.

Hyst_enable and hyst_trigger work with the PS_TH (threshold) settings to provide jitter control of the INT function.

ALS_blanking disables the ALS during the time the IR LED is on during a PS measurement. This will eliminate the effect of the PS IR signal bouncing off cover glass and affecting the ALS value.

NOA3315

Table 17. PS_CONFIG Register (0x15)

Bit	7	6	5	4	3	2	1	0
Field	NA		hyst_enable	hyst_trigger	als_blanking	integration_time		

Field	Bit	Default	Description	
NA	7:6	XX	Don't Care	
hyst_enable	5	0	0	Disables hysteresis
			1	Enables hysteresis
hyst_trigger	4	0	0	Lower threshold with hysteresis
			1	Upper threshold with hysteresis
als_blanking	3	1	0	Disables ALS blanking
			1	Enables ALS blanking
integration_time	2:0	011	000	150 μs integration time
			001	300 μs integration time
			010	600 μs integration time
			011	1200 μs integration time
			100	1800 μs integration time
			101	2400 μs integration time
			110	3600 μs integration time
			111	4800 μs integration time

PS_INTERVAL Register (0x16)

The PS_INTERVAL register sets the wait time between consecutive proximity measurements in PS_Repeat mode. The register is binary weighted times 10 in milliseconds plus

10ms. The range is therefore 10 ms to 1.28 s. The default startup value is 0x04 (50 ms).

Table 18. PS_INTERVAL Register (0x16)

Bit	7	6	5	4	3	2	1	0
Field	NA		interval					

Field	Bit	Default	Description	
NA	7	0		
Interval	6:0	0x04	0x00 to 0x7F	Interval time between measurement cycles. Binary weighted value times 10 ms plus a 10 ms offset.

PS_CONTROL Register (0x17)

The PS_CONTROL register is used to control the functional mode and commencement of proximity sensor measurements. The proximity sensor can be operated in either a single shot mode or consecutive measurements taken at programmable intervals.

Both single shot and repeat modes consume a minimum of power by immediately turning off LED driver and sensor circuitry after each measurement. In both cases the quiescent current is less than the IDD_{STBY} parameter. These automatic power management features eliminate the need for power down pins or special power down instructions.

Table 19. PS_CONTROL Register (0x17)

Bit	7	6	5	4	3	2	1	0
Field	NA						PS_Repeat	PS_OneShot

Field	Bit	Default	Description
NA	7:2	XXXXXX	Don't care
PS_Repeat	1	0	Initiates new measurements at PS_Interval rates
PS_OneShot	0	0	Triggers proximity sensing measurement. In single shot mode this bit clears itself after cycle completion.

ALS_TH Registers (0x20 – 0x23)

With hysteresis not enabled (see ALS_CONFIG register), the ALS_TH registers set the upper and lower interrupt thresholds of the ambient light detection window. Interrupt functions compare these threshold values to data from the ALS_DATA1 registers. Measured ALS_DATA1 values outside this window will set an interrupt according to the INT_CONFIG register settings.

With hysteresis enabled, threshold settings take on a different meaning. If the ALS_hyst_trig is set, the

ALS_TH_UP register sets the upper threshold at which an interrupt will be set, while the ALS_TH_LO register then sets the lower threshold hysteresis value where the interrupt would be cleared. Setting the ALS_hyst_trig low reverses the function such that the ALS_TH_LO register sets the lower threshold at which an interrupt will be set and the ALS_TH_UP represents the hysteresis value at which the interrupt would be subsequently cleared. Hysteresis functions only apply in “auto_clear” INT_CONFIG mode.

Table 20. ALS_TH_UP Registers (0x20 – 0x21)

Bit	7	6	5	4	3	2	1	0
Field	ALS_TH_UP_MSB(0x20), ALS_TH_UP_LSB(0x21)							

Field	Bit	Default	Description
ALS_TH_UP_MSB	7:0	0xFF	Upper threshold for ALS detection, MSB
ALS_TH_UP_LSB	7:0	0xFF	Upper threshold for ALS detection, LSB

Table 21. ALS_TH_LO Registers (0x22 – 0x23)

Bit	7	6	5	4	3	2	1	0
Field	ALS_TH_LO_MSB(0x22), ALS_TH_LO_LSB(0x23)							

Field	Bit	Default	Description
ALS_TH_LO_MSB	7:0	0x00	Lower threshold for ALS detection, MSB
ALS_TH_LO_LSB	7:0	0x00	Lower threshold for ALS detection, LSB

ALS_FILTER_CONFIG Register (0x24)

ALS_FILTER_CONFIG register provides a hardware mechanism to filter out single event occurrences or similar anomalies from causing unwanted interrupts. Two 4 bit registers (M and N) can be set with values such that M out of N measurements must exceed threshold settings in order

to set an interrupt. The default setting of 1 out of 1 effectively turns the filter off and any single measurement exceeding thresholds can trigger an interrupt. N must be greater than or equal to M. A setting of 0 for either M or N is not allowed and disables the ALS Interrupt.

Table 22. ALS_FILTER_CONFIG Register (0x24)

Bit	7	6	5	4	3	2	1	0
Field	filter_N				filter_M			

Field	Bit	Default	Description
filter_N	7:4	0001	Filter N
filter_M	3:0	0001	Filter M

ALS_CONFIG Register (0x25)

The ALS_CONFIG register controls the operation of the ambient light sensors. Als2_enable and als1_enable allow the desired sensors to be used while powering off unused sensors. Hyst_enable and hyst_trigger work with the ALS_TH (threshold) settings to provide jitter control of the INT function. The ambient light measurement sensitivity is controlled by specifying the integration time.

For backwards compatibility, if both als1_enable and als2_enable are zero, ALS1 is enabled. If no ALS measurements are desired, do not issue an ALS start command (register 0x27).

Range settings control the ALS sensitivity. The default setting (00) is the maximum sensitivity at 100 counts per lux. Bit 3 simply performs a logical divide by 10 of the ALS counts which allows for a 1 count per lux range. Note that 10 counts per lux can be obtained either by 01 – which is an analog range change, or by 10 which is the 100 count per lux range divided by 10. The “counts per lux” is based on the default integration time of 50 ms.

Table 23. ALS_CONFIG Register (0x25)

Bit	7	6	5	4	3	2	1	0
Field	als2_enable	als1_enable	hyst_enable	hyst_trigger	range		integration_time	

Field	Bit	Default	Description	
als2_enable	7	0	0	Disables ALS2 (unfiltered ALS)
			1	Enables ALS2
als1_enable	6	1	0	Disables ALS1 (ALS with photopic filter)
			1	Enables ALS1
hyst_enable	5	0	0	Disables hysteresis
			1	Enables hysteresis
hyst_trigger	4	0	0	Lower threshold with hysteresis
			1	Upper threshold with hysteresis
range	3:2	00	00	100 counts per lux
			01	10 counts per lux
			10	10 counts per lux (method 2)
			11	1 count per lux
integration_time	1:0	00	00	50 ms integration time
			01	100 ms integration time
			10	200 ms integration time
			11	400 ms integration time

ALS_INTERVAL Register (0x26)

The ALS_INTERVAL register sets the interval between consecutive ALS measurements in ALS_Repeat mode. The register is binary weighted times 50 in milliseconds. The range is 0 ms to 3.15 s. The register value 0x00 and 0 ms translates into a continuous loop measurement mode at any integration time. The default startup value is 0x0A (500 ms).

The als_power bit is used to keep the ALS powered up at a low current (~10 µA) for use in low light environments (for instance with 1% transmission glass). It is not needed if the ALS is run in repeat mode or single shot mode at least every 500 ms. The default is 0, which does not keep the ALS powered up.

Table 24. ALS_INTERVAL Register (0x26)

Bit	7	6	5	4	3	2	1	0
Field	NA	als_power	interval					

Field	Bit	Default	Description
als_power	6	0	Keeps ALS powered up
interval	5:0	0x0A	Interval time between ALS measurement cycles

ALS_CONTROL Register (0x27)

The ALS_CONTROL register is used to control the functional mode and commencement of ambient light sensor measurements. The ambient light sensor can be operated in either a single shot mode or consecutive measurements taken at programmable intervals.

Both single shot and repeat modes consume a minimum of power by immediately turning off sensor circuitry after each measurement. In both cases the quiescent current is less

than the IDD_{STBY} parameter. These automatic power management features eliminate the need for power down pins or special power down instructions.

For accurate measurements at low light levels (below approximately 3 lux) ALS readings must be taken at least once per second and the first measurement after a reset (software reset or power cycling) should be ignored.

Table 25. ALS_CONTROL Register (0x27)

Bit	7	6	5	4	3	2	1	0
Field	NA						ALS_Repeat	ALS_OneShot

Field	Bit	Default	Description
NA	7:2	XXXXXX	Don't care
ALS_Repeat	1	0	Initiates new measurements at ALS_Interval rates
ALS_OneShot	0	0	Triggers ALS sensing measurement. In single shot mode this bit clears itself after cycle completion.

INTERRUPT Register (0x40)

The INTERRUPT register displays the status of the interrupt pin and if an interrupt was caused by the proximity or ambient light sensor. If “auto_clear” is disabled (see

INT_CONFIG register), reading this register also will clear the interrupt.

Table 26. INTERRUPT Register (0x40)

Bit	7	6	5	4	3	2	1	0
Field	NA			INT	ALS_intH	ALS_intL	PS_intH	PS_intL

Field	Bit	Default	Description
NA	7:5	XXX	Don't care
INT	4	0	Status of external interrupt pin (1 is asserted)
ALS_intH	3	0	Interrupt caused by ALS exceeding maximum
ALS_intL	2	0	Interrupt caused by ALS falling below the minimum
PS_intH	1	0	Interrupt caused by PS exceeding maximum
PS_intL	0	0	Interrupt caused by PS falling below the minimum

PS_DATA Registers (0x41 – 0x42)

The PS_DATA registers store results from completed proximity measurements. When an I²C read operation begins, the current PS_DATA registers are locked until the

operation is complete (I2C_STOP received) to prevent possible data corruption from a concurrent measurement cycle.

Table 27. PS_DATA Registers (0x41 – 0x42)

Bit	7	6	5	4	3	2	1	0
Field	PS_DATA_MSB(0x41), PS_DATA_LSB(0x42)							

Field	Bit	Default	Description
PS_DATA_MSB	7:0	0x00	Proximity measurement data, MSB
PS_DATA_LSB	7:0	0x00	Proximity measurement data, LSB

NOA3315

ALS1_DATA Registers (0x43 – 0x44)

The ALS1_DATA registers store results from completed ALS1 measurements. When an I²C read operation begins, the current ALS1_DATA registers are locked until the

operation is complete (I2C_STOP received) to prevent possible data corruption from a concurrent measurement cycle.

Table 28. ALS1_DATA Registers (0x43 – 0x44)

Bit	7	6	5	4	3	2	1	0
Field	ALS1_DATA_MSB(0x43), ALS1_DATA_LSB(0x44)							

Field	Bit	Default	Description
ALS1_DATA_MSB	7:0	0x00	ALS1 measurement data, MSB
ALS1_DATA_LSB	7:0	0x00	ALS1 measurement data, LSB

ALS2_DATA Registers (0x45 – 0x46)

The ALS2_DATA registers store results from completed ALS2 measurements. When an I²C read operation begins, the current ALS2_DATA registers are locked until the

operation is complete (I2C_STOP received) to prevent possible data corruption from a concurrent measurement cycle.

Table 29. ALS2_DATA REGISTERS (0x45 – 0x46)

Bit	7	6	5	4	3	2	1	0
Field	ALS2_DATA_MSB(0x45), ALS2_DATA_LSB(0x46)							

Field	Bit	Default	Description
ALS2_DATA_MSB	7:0	0x00	ALS2 measurement data, MSB
ALS2_DATA_LSB	7:0	0x00	ALS2 measurement data, LSB

Proximity Sensor Operation

NOA3315 operation is divided into three phases: power up, configuration and operation. On power up the device initiates a reset which initializes the configuration registers to their default values and puts the device in the standby state. At any time, the host system may initiate a software reset by writing 0x01 to register 0x01. A software reset performs the same function as a power-on-reset.

The configuration phase may be skipped if the default register values are acceptable, but typically it is desirable to change some or all of the configuration register values. Configuration is accomplished by writing the desired configuration values to registers 0x02 through 0x17. Writing to configuration registers can be done with either individual I²C byte-write commands or with one or more I²C block write commands. Block write commands specify the first register address and then write multiple bytes of data in sequence. The NOA3315 automatically increments the register address as it acknowledges each byte transfer.

Proximity sensor measurement is initiated by writing appropriate values to the CONTROL register (0x17).

Sending an I2C_STOP sequence at the end of the write signals the internal state machines to wake up and begin the next measurement cycle. Figure 25 and Figure 26 illustrate the activity of key signals during a proximity sensor measurement cycle. The cycle begins by starting the precision oscillator and powering up the proximity sensor receiver. Next, the IR LED current is modulated according to the LED current setting at the chosen LED frequency and the values during both the on and off times of the LED are stored (illuminated and ambient values). Finally, the proximity reading is calculated by subtracting the ambient value from the illuminated value and storing the result in the 16 bit PS_Data register. In One-shot mode, the PS receiver is then powered down and the oscillator is stopped (unless there is an active ALS measurement). If Repeat mode is set, the PS receiver is powered down for the specified interval and the process is repeated. With default configuration values (receiver integration time = 1200 μs), the total measurement cycle will be less than 2 ms.

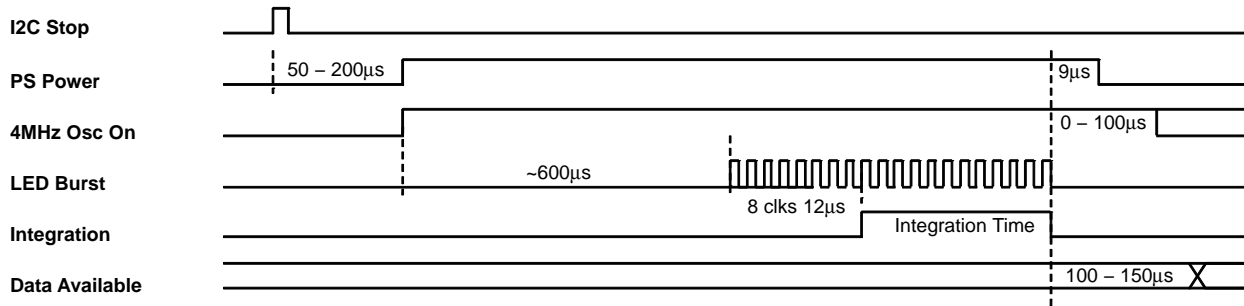

Figure 25. Proximity Sensor One-Shot Timing

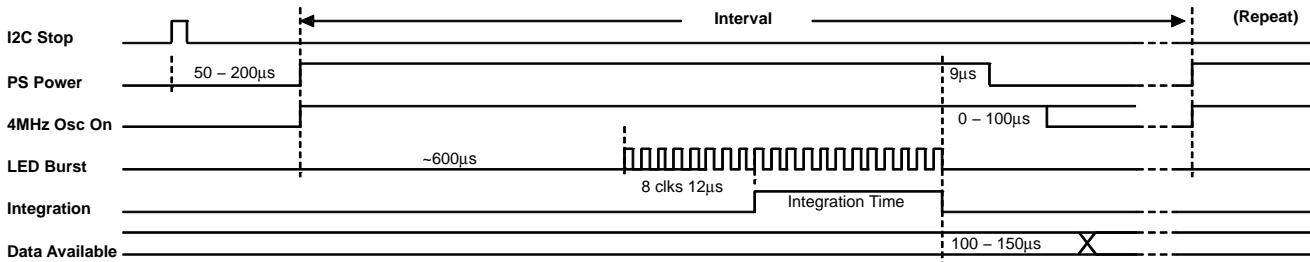

Figure 26. Proximity Sensor Repeat Timing

Ambient Light Sensor Operation

The NOA3315 supports dual ambient light sensors. ALS1 has a photopic filter which closely mimics the spectral response of the human eye. ALS2 has no filters. In many respects ALS1 and ALS2 are similar, but each sensor can be separately enabled or disabled and each ALS has its own data registers. ALS1 and ALS2 share control, configuration and operational details except that ALS2 is not compared to the threshold registers and cannot create an interrupt. ALS1 and ALS2 support simultaneous concurrent measurements allowing the two sensor values to be read out and used in computations as desired.

ALS configuration is accomplished by writing the desired configuration values to registers 0x02 and 0x20 through 0x27. Writing to configuration registers can be done with either individual I²C byte-write commands or with one or more I²C block write commands. Block write commands specify the first register address and then write multiple bytes of data in sequence. The NOA3315 automatically increments the register address as it acknowledges each byte transfer.

ALS measurement is initiated by writing appropriate values to the CONTROL register (0x27). Sending an I²C_STOP sequence at the end of the write signals the internal state machines to wake up and begin the next measurement cycle. Figure 27 and Figure 28 illustrate the activity of key signals during an ambient light sensor measurement cycle. The cycle begins by starting the calibrated low frequency (LF) oscillator and powering up the ambient light sensor. Next, the ambient light measurement is made for the specified integration time and the result is stored in the appropriate 16 bit ALS Data registers. If in One-shot mode, the ALS is powered down and awaits the next command. If in Repeat mode the ALS is powered down, the interval is timed out and the operation repeated. There are some special cases if the interval timer is set to less than the integration time. For continuous mode, the interval is set to either 0 or a value less than or equal to the integration time and the ALS makes continuous measurements with only a 5 μs delay between integration times and the ALS remains powered up.

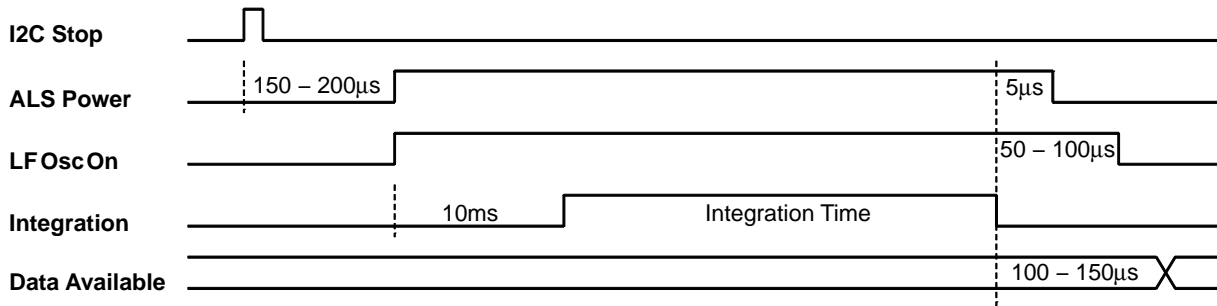
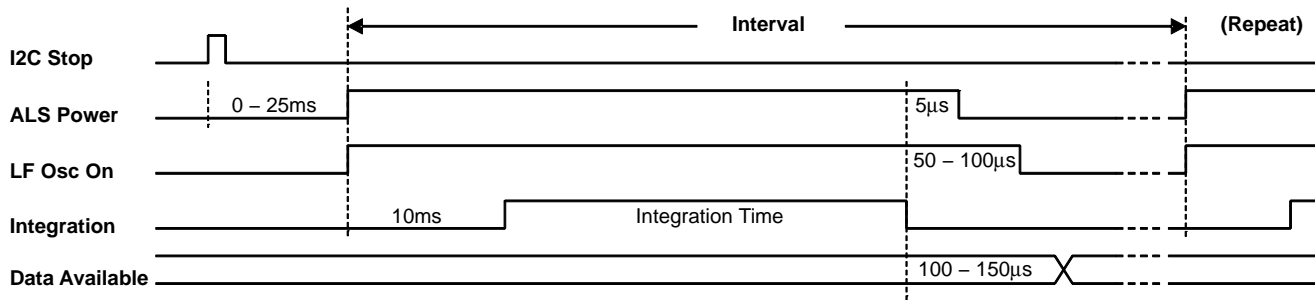

Figure 27. ALS One-Shot Timing



NOTE: If Interval is set to 0 (continuous) the time between integrations is 5 μs and power stays on.
 If Interval is set to ≤ to the integration time (but not 0) the time between integrations is 10 ms and power stays on.
 If Interval is set to > integration time the time between integrations is the interval and the ALS powers down.

Figure 28. ALS Repeat Timing

NOA3315

Example Programming Sequence

The following pseudo code configures the NOA3315 proximity sensor in repeat mode with 50 ms wait time between each measurement and then runs it in an interrupt driven mode. When the controller receives an interrupt, the

interrupt determines if the interrupts was caused by the proximity sensor and if so, reads the PS_Data from the device, sets a flag and then waits for the main polling loop to respond to the proximity change.

```
external subroutine I2C_Read_Byte (I2C_Address, Data_Address);
external subroutine I2C_Read_Block (I2C_Address, Data_Start_Address, Count, Memory_Map);
external subroutine I2C_Write_Byte (I2C_Address, Data_Address, Data);
external subroutine I2C_Write_Block (I2C_Address, Data_Start_Address, Count, Memory_Map);
subroutine Initialize_PS () {
  MemBuf[0x02] = 0x02; // INT_CONFIG assert interrupt until cleared
  MemBuf[0x0F] = 0x09; // PS_LED_CURRENT 50mA
  MemBuf[0x10] = 0x8F; // PS_TH_UP_MSB
  MemBuf[0x11] = 0xFF; // PS_TH_UP_LSB
  MemBuf[0x12] = 0x70; // PS_TH_LO_MSB
  MemBuf[0x13] = 0x00; // PS_TH_LO_LSB
  MemBuf[0x14] = 0x11; // PS_FILTER_CONFIG turn off filtering
  MemBuf[0x15] = 0x09; // PS_CONFIG ALS blanking enabled, 300us integration time
  MemBuf[0x16] = 0x0A; // PS_INTERVAL 50ms wait
  MemBuf[0x17] = 0x02; // PS_CONTROL enable continuous PS measurements
  MemBuf[0x20] = 0xFF; // ALS_TH_UP_MSB
  MemBuf[0x21] = 0xFF; // ALS_TH_UP_LSB
  MemBuf[0x22] = 0x00; // ALS_TH_LO_MSB
  MemBuf[0x23] = 0x00; // ALS_TH_LO_LSB
  MemBuf[0x25] = 0x40; // ALS_CONFIG ALS2 disabled, ALS1 enabled, max sensitivity, 50ms
integration time
  MemBuf[0x26] = 0x00; // ALS_INTERVAL continuous measurement mode
  MemBuf[0x27] = 0x02; // ALS_CONTROL enable continuous ALS measurements
  I2C_Write_Block (I2CAddr, 0x02, 37, MemBuf);
}
subroutine I2C_Interupt_Handler () {
  // Verify this is a PS interrupt
  INT = I2C_Read_Byte (I2CAddr, 0x40);
  if (INT == 0x11 || INT == 0x12) {
    // Retrieve and store the PS data
    PS_Data_MSB = I2C_Read_Byte (I2CAddr, 0x41);
    PS_Data_LSB = I2C_Read_Byte (I2CAddr, 0x42);
    NewPS = 0x01;
  }
}
subroutine main_loop () {
  I2CAddr = 0x37;
  NewPS = 0x00;
  Initialize_PS ();
  loop {
    // Do some other polling operations
    if (NewPS == 0x01) {
      NewPS = 0x00;
      // Do some operations with PS_Data
    }
  }
}
```

NOA3315

Physical Location of Photodiode Sensors

The physical locations of the NOA3315 proximity sensor and ambient light sensor photodiodes are shown in Figure 29.

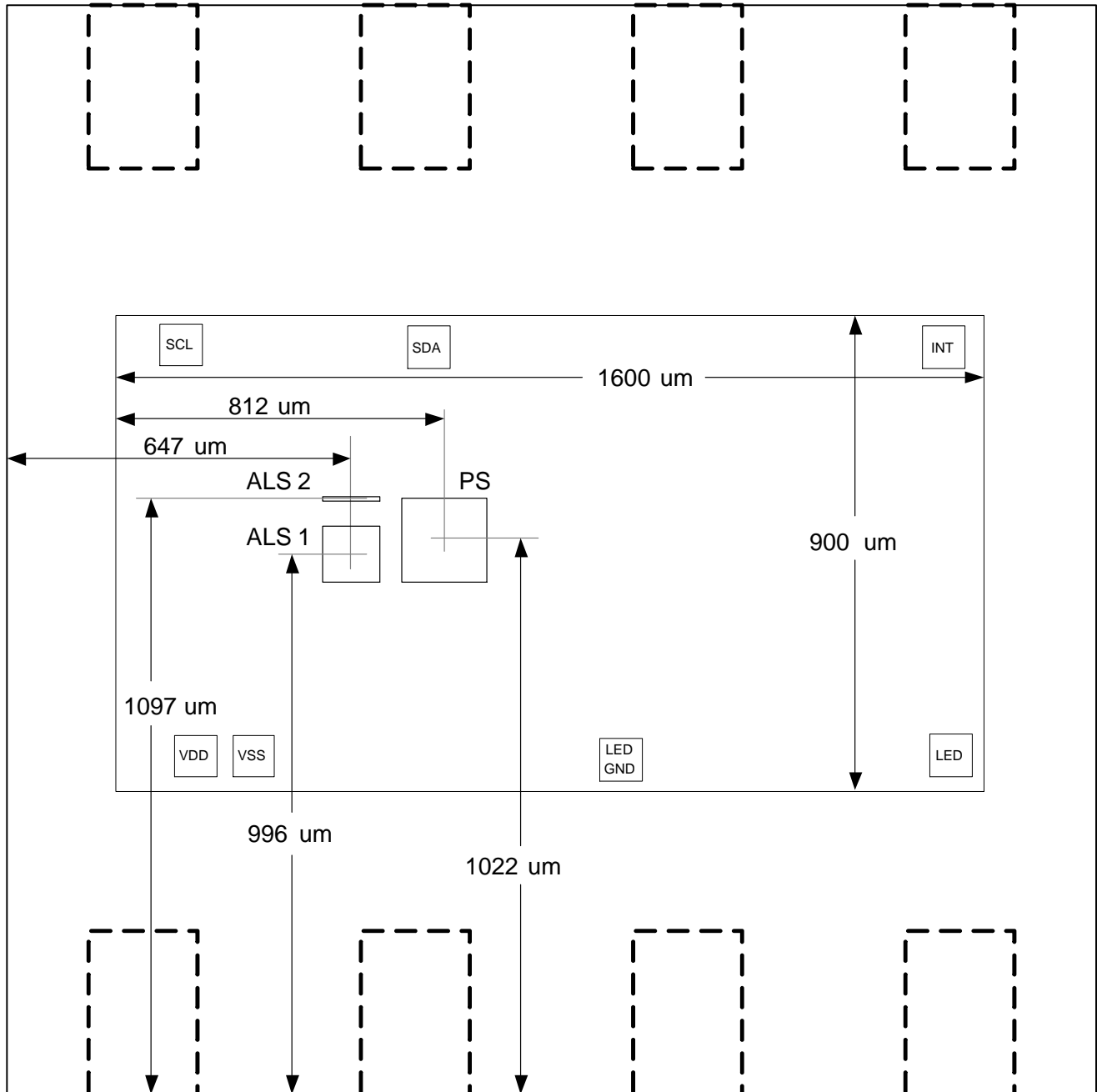

Figure 29. Photodiode Locations

MECHANICAL CASE OUTLINE

PACKAGE DIMENSIONS

ON Semiconductor®



SCALE 2:1

CUDFN8, 2x2, 0.5P
CASE 505AP
ISSUE O

DATE 19 DEC 2016

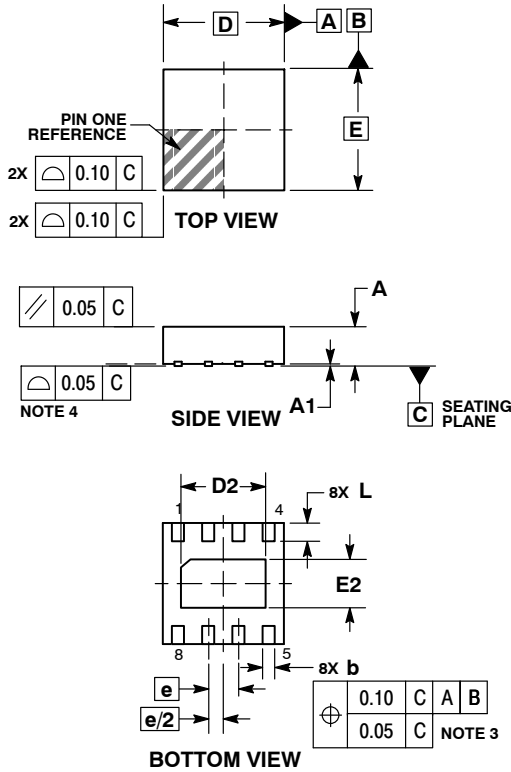

NOTES:

1. DIMENSIONING AND TOLERANCING PER ASME Y14.5M, 1994.
2. CONTROLLING DIMENSION: MILLIMETERS.
3. DIMENSION b APPLIES TO PLATED TERMINAL AND IS MEASURED BETWEEN 0.15 AND 0.30 MM FROM THE TERMINAL TIP. COPLANARITY APPLIES TO THE EXPOSED PAD AS WELL AS THE TERMINALS.

MILLIMETERS		
DIM	MIN	MAX
A	0.55	0.65
A1	0.00	0.05
b	0.20	0.30
D	2.00 BSC	
D2	1.30	1.50
E	2.00 BSC	
E2	0.70	0.90
e	0.50 BSC	
L	0.25	0.35

GENERIC MARKING DIAGRAM*

(*Note: Clear package, no marking is present)

RECOMMENDED MOUNTING FOOTPRINT*

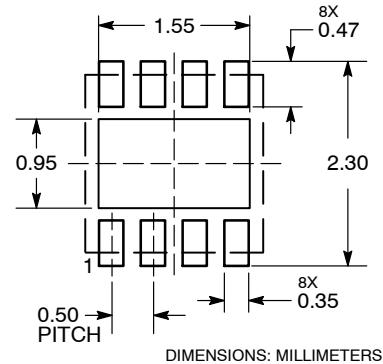

*For additional information on our Pb-Free strategy and soldering details, please download the ON Semiconductor Soldering and Mounting Techniques Reference Manual, SOLDERRM/D.

DOCUMENT NUMBER:	98AON19255G	Electronic versions are uncontrolled except when accessed directly from the Document Repository. Printed versions are uncontrolled except when stamped "CONTROLLED COPY" in red.
DESCRIPTION:	CUDFN8 2X2, 0.5P	PAGE 1 OF 1

ON Semiconductor and are trademarks of Semiconductor Components Industries, LLC dba ON Semiconductor or its subsidiaries in the United States and/or other countries. ON Semiconductor reserves the right to make changes without further notice to any products herein. ON Semiconductor makes no warranty, representation or guarantee regarding the suitability of its products for any particular purpose, nor does ON Semiconductor assume any liability arising out of the application or use of any product or circuit, and specifically disclaims any and all liability, including without limitation special, consequential or incidental damages. ON Semiconductor does not convey any license under its patent rights nor the rights of others.

ON Semiconductor and  are trademarks of Semiconductor Components Industries, LLC dba ON Semiconductor or its subsidiaries in the United States and/or other countries. ON Semiconductor owns the rights to a number of patents, trademarks, copyrights, trade secrets, and other intellectual property. A listing of ON Semiconductor's product/patent coverage may be accessed at www.onsemi.com/site/pdf/Patent-Marking.pdf. ON Semiconductor reserves the right to make changes without further notice to any products herein. ON Semiconductor makes no warranty, representation or guarantee regarding the suitability of its products for any particular purpose, nor does ON Semiconductor assume any liability arising out of the application or use of any product or circuit, and specifically disclaims any and all liability, including without limitation special, consequential or incidental damages. Buyer is responsible for its products and applications using ON Semiconductor products, including compliance with all laws, regulations and safety requirements or standards, regardless of any support or applications information provided by ON Semiconductor. "Typical" parameters which may be provided in ON Semiconductor data sheets and/or specifications can and do vary in different applications and actual performance may vary over time. All operating parameters, including "Typicals" must be validated for each customer application by customer's technical experts. ON Semiconductor does not convey any license under its patent rights nor the rights of others. ON Semiconductor products are not designed, intended, or authorized for use as a critical component in life support systems or any FDA Class 3 medical devices or medical devices with a same or similar classification in a foreign jurisdiction or any devices intended for implantation in the human body. Should Buyer purchase or use ON Semiconductor products for any such unintended or unauthorized application, Buyer shall indemnify and hold ON Semiconductor and its officers, employees, subsidiaries, affiliates, and distributors harmless against all claims, costs, damages, and expenses, and reasonable attorney fees arising out of, directly or indirectly, any claim of personal injury or death associated with such unintended or unauthorized use, even if such claim alleges that ON Semiconductor was negligent regarding the design or manufacture of the part. ON Semiconductor is an Equal Opportunity/Affirmative Action Employer. This literature is subject to all applicable copyright laws and is not for resale in any manner.

PUBLICATION ORDERING INFORMATION

LITERATURE FULFILLMENT:

Email Requests to: orderlit@onsemi.com

ON Semiconductor Website: www.onsemi.com

TECHNICAL SUPPORT

North American Technical Support:
Voice Mail: 1 800-282-9855 Toll Free USA/Canada
Phone: 011 421 33 790 2910

Europe, Middle East and Africa Technical Support:

Phone: 00421 33 790 2910

For additional information, please contact your local Sales Representative