

MOSFET – SiC Power, Single N-Channel, TO247-3L

900 V, 20 mΩ, 118 A

NTHL020N090SC1

Features

- Typ. $R_{DS(on)} = 20\text{ m}\Omega$
- Ultra Low Gate Charge ($Q_{G(tot)} = 196\text{ nC}$)
- Low Effective Output Capacitance ($C_{oss} = 296\text{ pF}$)
- 100% UIL Tested
- RoHS Compliant

Typical Applications

- UPS
- DC/DC Converter
- Boost Inverter

MAXIMUM RATINGS ($T_J = 25^\circ\text{C}$ unless otherwise noted)

Parameter		Symbol	Value	Unit	
Drain-to-Source Voltage		V_{DSS}	900	V	
Gate-to-Source Voltage		V_{GS}	+19/-10	V	
Recommended Operation Values of Gate – Source Voltage		$T_C < 175^\circ\text{C}$ V_{GSop}	+15/-5	V	
Continuous Drain Current $R_{\theta JC}$	Steady State	$T_C = 25^\circ\text{C}$	I_{DC}	118	A
			P_{DC}	503	W
Continuous Drain Current $R_{\theta JC}$	Steady State	$T_C = 100^\circ\text{C}$	I_{DC}	83	A
			P_{DC}	251	W
Pulsed Drain Current (Note 2)		$T_A = 25^\circ\text{C}$	I_{DM}	472	A
Single Pulse Surge Drain Current Capability (Note 3)	$T_A = 25^\circ\text{C}$, $t_p = 10\text{ }\mu\text{s}$, $R_G = 4.7\text{ }\Omega$	I_{DSC}	854	A	
Operating Junction and Storage Temperature Range		T_J, T_{stg}	-55 to +175	$^\circ\text{C}$	
Source Current (Body Diode)		I_S	153	A	
Single Pulse Drain-to-Source Avalanche Energy ($I_L = 23\text{ A}_{pk}$, $L = 1\text{ mH}$) (Note 4)		E_{AS}	264	mJ	

Stresses exceeding those listed in the Maximum Ratings table may damage the device. If any of these limits are exceeded, device functionality should not be assumed, damage may occur and reliability may be affected.

1. The entire application environment impacts the thermal resistance values shown, they are not constants and are only valid for the particular conditions noted.
2. Repetitive rating, limited by max junction temperature.
3. Peak current might be limited by transconductance.
4. E_{AS} of 162 mJ is based on starting $T_J = 25^\circ\text{C}$; $L = 1\text{ mH}$, $I_{AS} = 23\text{ A}$, $V_{DD} = 100\text{ V}$, $V_{GS} = 15\text{ V}$.



ON Semiconductor®

www.onsemi.com

$V_{(BR)DSS}$	$R_{DS(ON)}\text{ MAX}$	$I_D\text{ MAX}$
900 V	28 mΩ @ 15 V	118 A

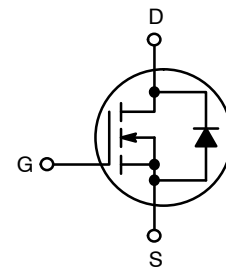

N-CHANNEL MOSFET

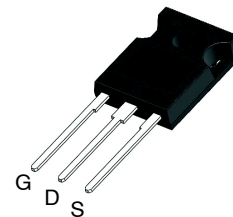

TO-247 LONG LEADS
CASE 340CX

MARKING DIAGRAM

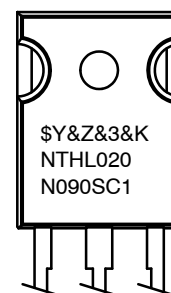

\$Y = ON Semiconductor Logo
 &Z = Assembly Plant Code
 &3 = Date Code (Year & Week)
 &K = Lot
 NTHL020N090SC1 = Specific Device Code

ORDERING INFORMATION

See detailed ordering and shipping information on page 6 of this data sheet.

NTHL020N090SC1

Table 1. THERMAL CHARACTERISTICS

Parameter	Symbol	Max	Units
Thermal Resistance Junction-to-Case (Note 1)	$R_{\theta JC}$	0.30	°C/W
Thermal Resistance Junction-to-Ambient (Note 1)	$R_{\theta JA}$	40	°C/W

Table 2. ELECTRICAL CHARACTERISTICS ($T_J = 25^\circ\text{C}$ unless otherwise stated)

Parameter	Symbol	Test Condition	Min	Typ	Max	Unit
OFF CHARACTERISTICS						
Drain-to-Source Breakdown Voltage	$V_{(BR)DSS}$	$V_{GS} = 0\text{ V}, I_D = 1\text{ mA}$	900			V
Drain-to-Source Breakdown Voltage Temperature Coefficient	$V_{(BR)DSS}/T_J$	$I_D = 1\text{ mA}$, refer to 25°C		500		mV/°C
Zero Gate Voltage Drain Current	I_{DSS}	$V_{GS} = 0\text{ V}$ $V_{DS} = 900\text{ V}$	$T_J = 25^\circ\text{C}$		100	μA
			$T_J = 175^\circ\text{C}$		250	μA
Gate-to-Source Leakage Current	I_{GSS}	$V_{GS} = +19/-10\text{ V}, V_{DS} = 0\text{ V}$			± 1	μA
ON CHARACTERISTICS						
Gate Threshold Voltage	$V_{GS(TH)}$	$V_{GS} = V_{DS}, I_D = 20\text{ mA}$	1.8	2.7	4.3	V
Recommended Gate Voltage	V_{GOP}		-5		+15	V
Drain-to-Source On Resistance	$R_{DS(on)}$	$V_{GS} = 15\text{ V}, I_D = 60\text{ A}, T_J = 25^\circ\text{C}$ $V_{GS} = 15\text{ V}, I_D = 60\text{ A}, T_J = 175^\circ\text{C}$		20	28	m Ω
				27		m Ω
Forward Transconductance	g_{FS}	$V_{DS} = 20\text{ V}, I_D = 60\text{ A}$		49		S
CHARGES, CAPACITANCES & GATE RESISTANCE						
Input Capacitance	C_{ISS}	$V_{GS} = 0\text{ V}, f = 1\text{ MHz},$ $V_{DS} = 450\text{ V}$		4415		pF
Output Capacitance	C_{OSS}			296		
Reverse Transfer Capacitance	C_{RSS}			24		
Total Gate Charge	$Q_{G(TOT)}$	$V_{GS} = -5/15\text{ V}, V_{DS} = 720\text{ V},$ $I_D = 60\text{ A}$		196		nC
Threshold Gate Charge	$Q_{G(TH)}$			42		
Gate-to-Source Charge	Q_{GS}			78		
Gate-to-Drain Charge	Q_{GD}			55		
Gate-Resistance	R_G	$f = 1\text{ MHz}$		1.6		Ω
SWITCHING CHARACTERISTICS						
Turn-On Delay Time	$t_{d(ON)}$	$V_{GS} = -5/15\text{ V}, V_{DS} = 720\text{ V},$ $I_D = 60\text{ A}, R_G = 2.5\ \Omega,$ Inductive Load		40		ns
Rise Time	t_r			63		
Turn-Off Delay Time	$t_{d(OFF)}$			55		
Fall Time	t_f			13		
Turn-On Switching Loss	E_{ON}			2025		μJ
Turn-Off Switching Loss	E_{OFF}			201		
Total Switching Loss	E_{TOT}			2226		
DRAIN-SOURCE DIODE CHARACTERISTICS						
Continuous Drain-Source Diode Forward Current	I_{SD}	$V_{GS} = -5\text{ V}, T_J = 25^\circ\text{C}$			153	A
Pulsed Drain-Source Diode Forward Current (Note 2)	I_{SDM}	$V_{GS} = -5\text{ V}, T_J = 25^\circ\text{C}$			472	A
Forward Diode Voltage	V_{SD}	$V_{GS} = -5\text{ V}, I_{SD} = 30\text{ A}, T_J = 25^\circ\text{C}$		3.8		V

NTHL020N090SC1

Table 2. ELECTRICAL CHARACTERISTICS ($T_J = 25^\circ\text{C}$ unless otherwise stated)

Parameter	Symbol	Test Condition	Min	Typ	Max	Unit
DRAIN-SOURCE DIODE CHARACTERISTICS						
Reverse Recovery Time	t_{RR}	$V_{GS} = -5/15\text{ V}, I_{SD} = 60\text{ A}, di_S/dt = 1000\text{ A}/\mu\text{s}, V_{DS} = 720\text{ V}$		28		ns
Reverse Recovery Charge	Q_{RR}			199		nC
Reverse Recovery Energy	E_{REC}			4		μJ
Peak Reverse Recovery Current	I_{RRM}			14		A
Charge time	T_a			16		ns
Discharge time	T_b			12		ns

Product parametric performance is indicated in the Electrical Characteristics for the listed test conditions, unless otherwise noted. Product performance may not be indicated by the Electrical Characteristics if operated under different conditions.

TYPICAL CHARACTERISTICS

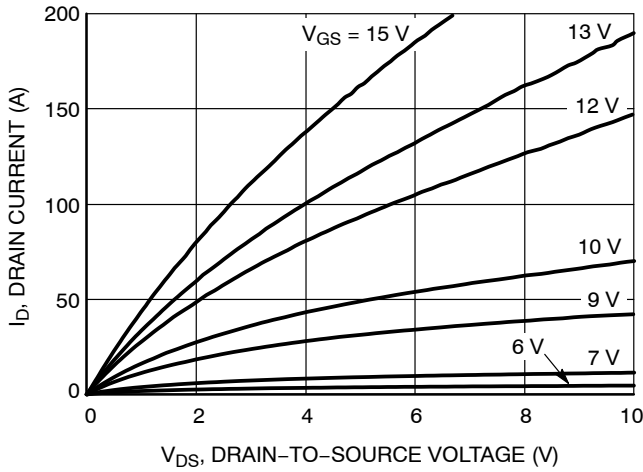

Figure 1. On-Region Characteristics

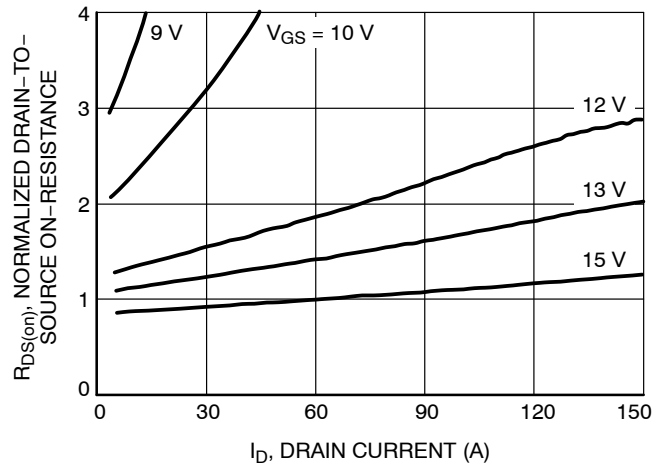

Figure 2. Normalized On-Resistance vs. Drain Current and Gate Voltage

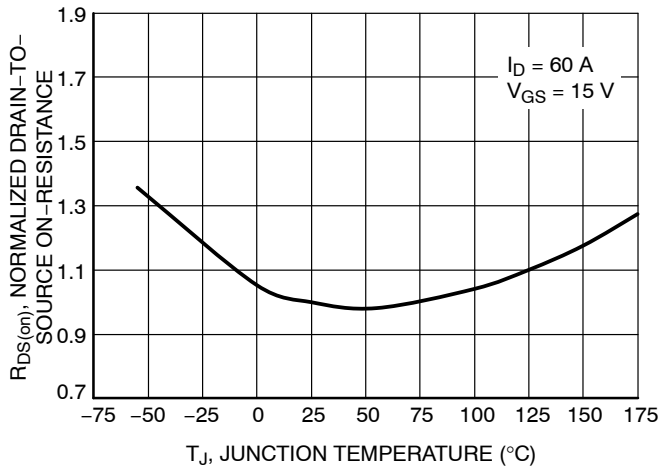

Figure 3. On-Resistance Variation with Temperature

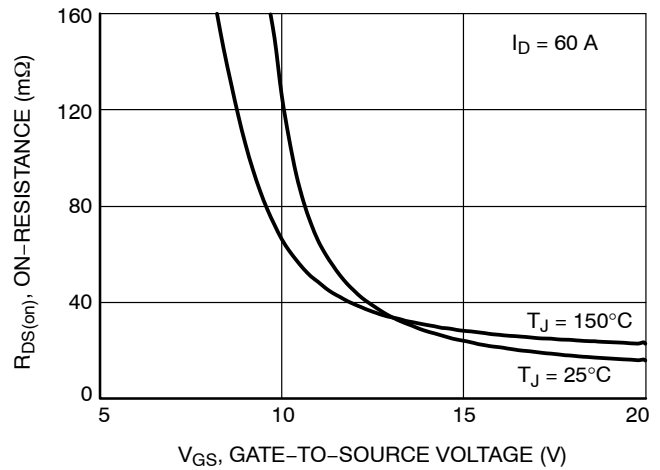

Figure 4. On-Resistance vs. Gate-to-Source Voltage

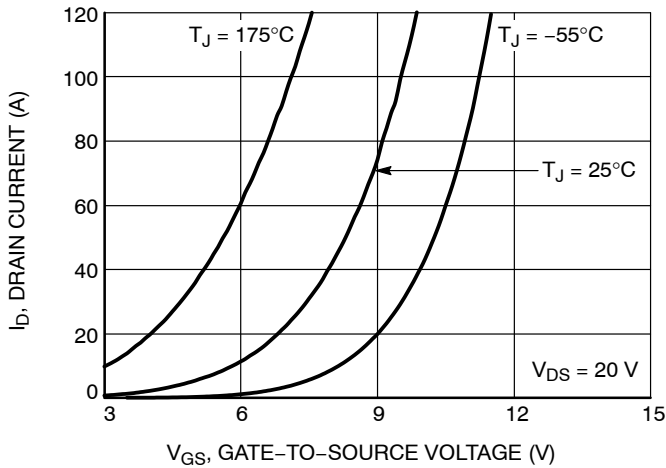

Figure 5. Transfer Characteristics

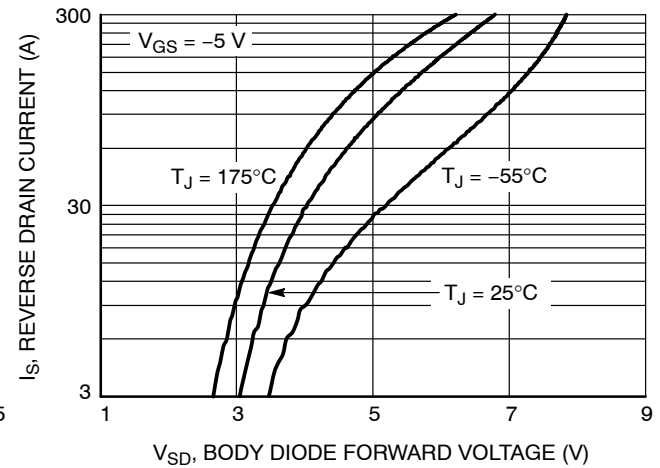

Figure 6. Diode Forward Voltage vs. Current

TYPICAL CHARACTERISTICS

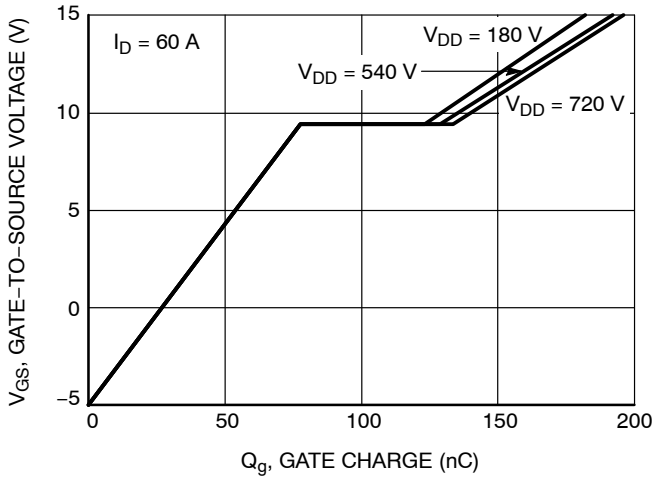

Figure 7. Gate-to-Source Voltage vs. Total Charge

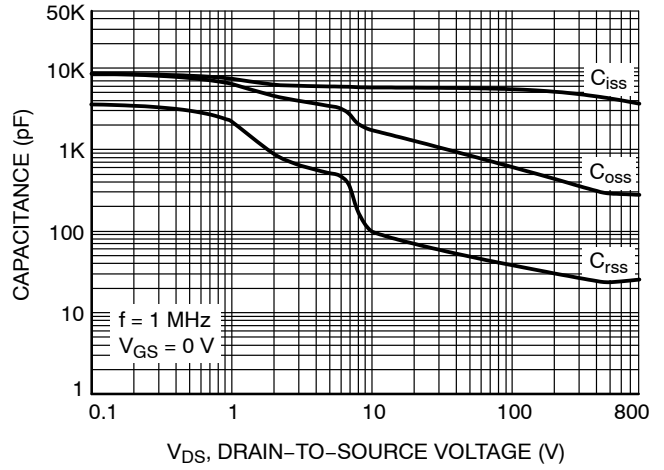

Figure 8. Capacitance vs. Drain-to-Source Voltage

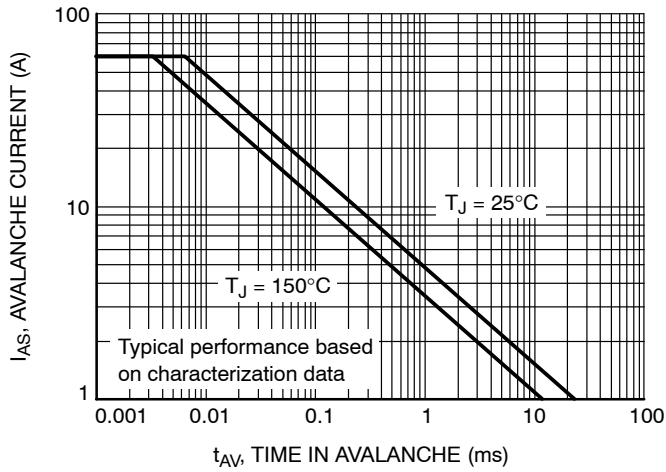

Figure 9. Unclamped Inductive Switching Capability

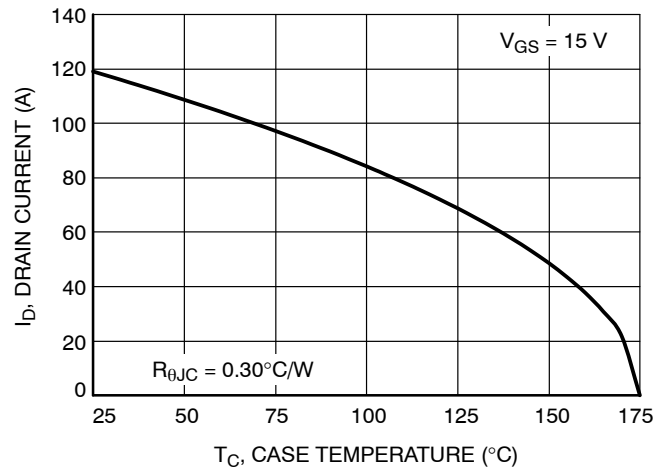

Figure 10. Maximum Continuous Drain Current vs. Case Temperature

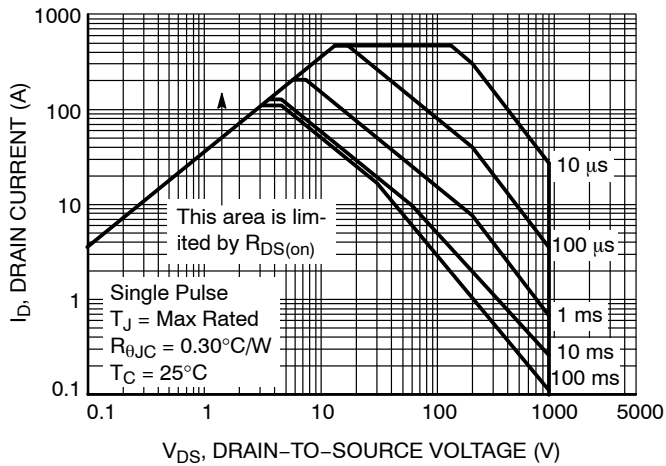

Figure 11. Safe Operating Area

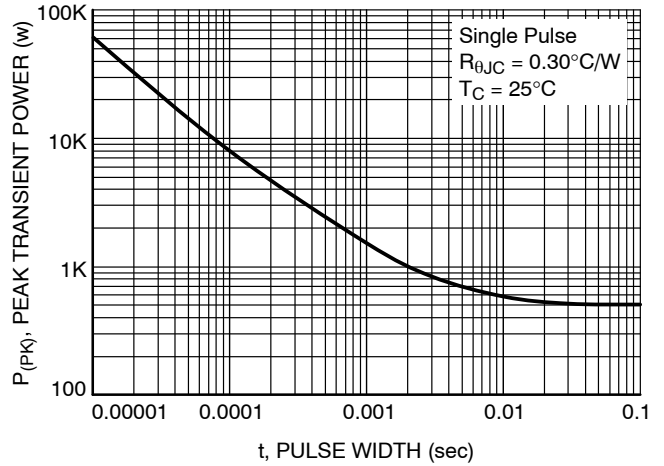

Figure 12. Single Pulse Maximum Power Dissipation

NTHL020N090SC1

TYPICAL CHARACTERISTICS

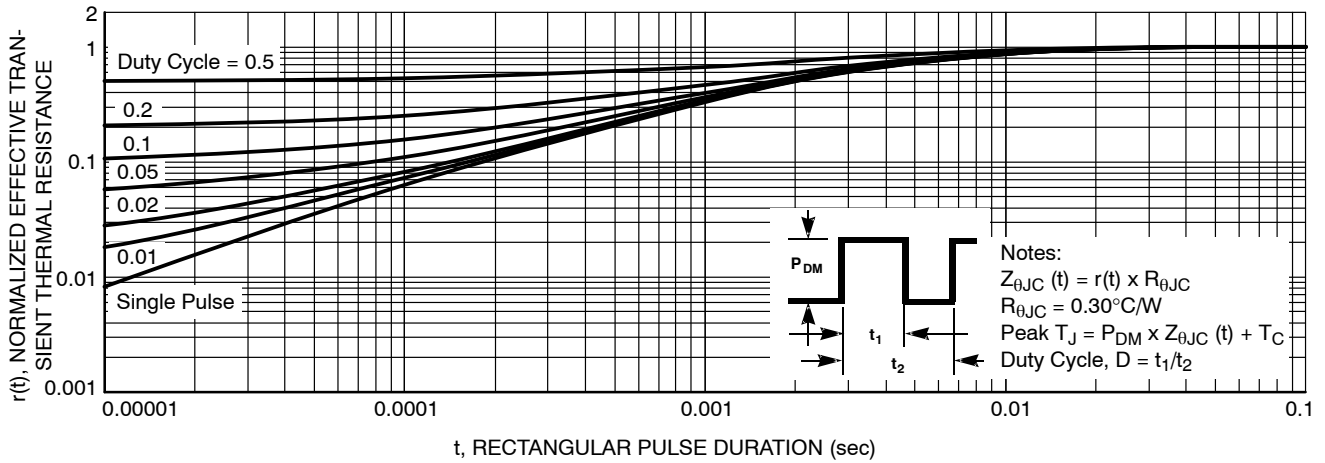

Figure 13. Junction-to-Ambient Transient Thermal Response Curve

PACKAGE MARKING AND ORDERING INFORMATION

Part Number	Top Marking	Package	Packing Method	Reel Size	Tape Size	Quantity
NTHL020N090SC1	NTHL020N090SC1	TO-247 Long Lead	Tube	N/A	N/A	30 Units

MECHANICAL CASE OUTLINE

PACKAGE DIMENSIONS

ON Semiconductor®



TO-247-3LD
CASE 340CX
ISSUE A

DATE 06 JUL 2020



NOTES: UNLESS OTHERWISE SPECIFIED.

- A. DIMENSIONS ARE EXCLUSIVE OF BURRS, MOLD FLASH, AND TIE BAR EXTRUSIONS.
- B. ALL DIMENSIONS ARE IN MILLIMETERS.
- C. DRAWING CONFORMS TO ASME Y14.5 - 2009.
- D. DIMENSION A1 TO BE MEASURED IN THE REGION DEFINED BY L1.
- E. LEAD FINISH IS UNCONTROLLED IN THE REGION DEFINED BY L1.

DIM	MILLIMETERS		
	MIN	NOM	MAX
A	4.58	4.70	4.82
A1	2.20	2.40	2.60
A2	1.40	1.50	1.60
D	20.32	20.57	20.82
E	15.37	15.62	15.87
E2	4.96	5.08	5.20
e	~	5.56	~
L	19.75	20.00	20.25
L1	3.69	3.81	3.93
ØP	3.51	3.58	3.65
Q	5.34	5.46	5.58
S	5.34	5.46	5.58
b	1.17	1.26	1.35
b2	1.53	1.65	1.77
b4	2.42	2.54	2.66
c	0.51	0.61	0.71
D1	13.08	~	~
D2	0.51	0.93	1.35
E1	12.81	~	~
ØP1	6.60	6.80	7.00

GENERIC MARKING DIAGRAM*



- XXXXX = Specific Device Code
- A = Assembly Location
- Y = Year
- WW = Work Week
- G = Pb-Free Package

*This information is generic. Please refer to device data sheet for actual part marking. Pb-Free indicator, "G" or microdot "▪", may or may not be present. Some products may not follow the Generic Marking.

DOCUMENT NUMBER:	98AON93302G	Electronic versions are uncontrolled except when accessed directly from the Document Repository. Printed versions are uncontrolled except when stamped "CONTROLLED COPY" in red.
DESCRIPTION:	TO-247-3LD	PAGE 1 OF 1

ON Semiconductor and are trademarks of Semiconductor Components Industries, LLC dba ON Semiconductor or its subsidiaries in the United States and/or other countries. ON Semiconductor reserves the right to make changes without further notice to any products herein. ON Semiconductor makes no warranty, representation or guarantee regarding the suitability of its products for any particular purpose, nor does ON Semiconductor assume any liability arising out of the application or use of any product or circuit, and specifically disclaims any and all liability, including without limitation special, consequential or incidental damages. ON Semiconductor does not convey any license under its patent rights nor the rights of others.

ON Semiconductor and  are trademarks of Semiconductor Components Industries, LLC dba ON Semiconductor or its subsidiaries in the United States and/or other countries. ON Semiconductor owns the rights to a number of patents, trademarks, copyrights, trade secrets, and other intellectual property. A listing of ON Semiconductor's product/patent coverage may be accessed at www.onsemi.com/site/pdf/Patent-Marking.pdf. ON Semiconductor reserves the right to make changes without further notice to any products herein. ON Semiconductor makes no warranty, representation or guarantee regarding the suitability of its products for any particular purpose, nor does ON Semiconductor assume any liability arising out of the application or use of any product or circuit, and specifically disclaims any and all liability, including without limitation special, consequential or incidental damages. Buyer is responsible for its products and applications using ON Semiconductor products, including compliance with all laws, regulations and safety requirements or standards, regardless of any support or applications information provided by ON Semiconductor. "Typical" parameters which may be provided in ON Semiconductor data sheets and/or specifications can and do vary in different applications and actual performance may vary over time. All operating parameters, including "Typicals" must be validated for each customer application by customer's technical experts. ON Semiconductor does not convey any license under its patent rights nor the rights of others. ON Semiconductor products are not designed, intended, or authorized for use as a critical component in life support systems or any FDA Class 3 medical devices or medical devices with a same or similar classification in a foreign jurisdiction or any devices intended for implantation in the human body. Should Buyer purchase or use ON Semiconductor products for any such unintended or unauthorized application, Buyer shall indemnify and hold ON Semiconductor and its officers, employees, subsidiaries, affiliates, and distributors harmless against all claims, costs, damages, and expenses, and reasonable attorney fees arising out of, directly or indirectly, any claim of personal injury or death associated with such unintended or unauthorized use, even if such claim alleges that ON Semiconductor was negligent regarding the design or manufacture of the part. ON Semiconductor is an Equal Opportunity/Affirmative Action Employer. This literature is subject to all applicable copyright laws and is not for resale in any manner.

PUBLICATION ORDERING INFORMATION

LITERATURE FULFILLMENT:

Email Requests to: orderlit@onsemi.com

ON Semiconductor Website: www.onsemi.com

TECHNICAL SUPPORT

North American Technical Support:
Voice Mail: 1 800-282-9855 Toll Free USA/Canada
Phone: 011 421 33 790 2910

Europe, Middle East and Africa Technical Support:

Phone: 00421 33 790 2910

For additional information, please contact your local Sales Representative