

ON Semiconductor®



Schematic for the AR0135 Evaluation Board



AR0135_BGA_Demo3Head

Page	Description
1	Title Page
2	Block Diagram
3	Sensor
4	Power
5	Clock and Reset
6	External Interfaces

Rev	Who	Date	Description
Rev 0.0	aralex	05/07/14	Initial
Rev 0.0	aralex	05/08/14	Removed the 10nF Decaps on VDD and VDDIO for Sensor
		05/13/14	Updated the sensor with the new non socketed part, and added C-mount lens
		05/15/14	Updated the sensor with the new non socketed part, and added the socket for demo3 board
Rev 0.1	aralex	05/16/14	Removed text near R8 for TRIGGER signal Replaced R25 with a fixed resistor of 20K
	aralex	05/20/14	Removed Skip Block Fiducials FD4 and FD8.
Rev 1.0	aralex	04/23/15	Added a 2 pin header P28 for Trigger signal, deleted R8



Block Diagram

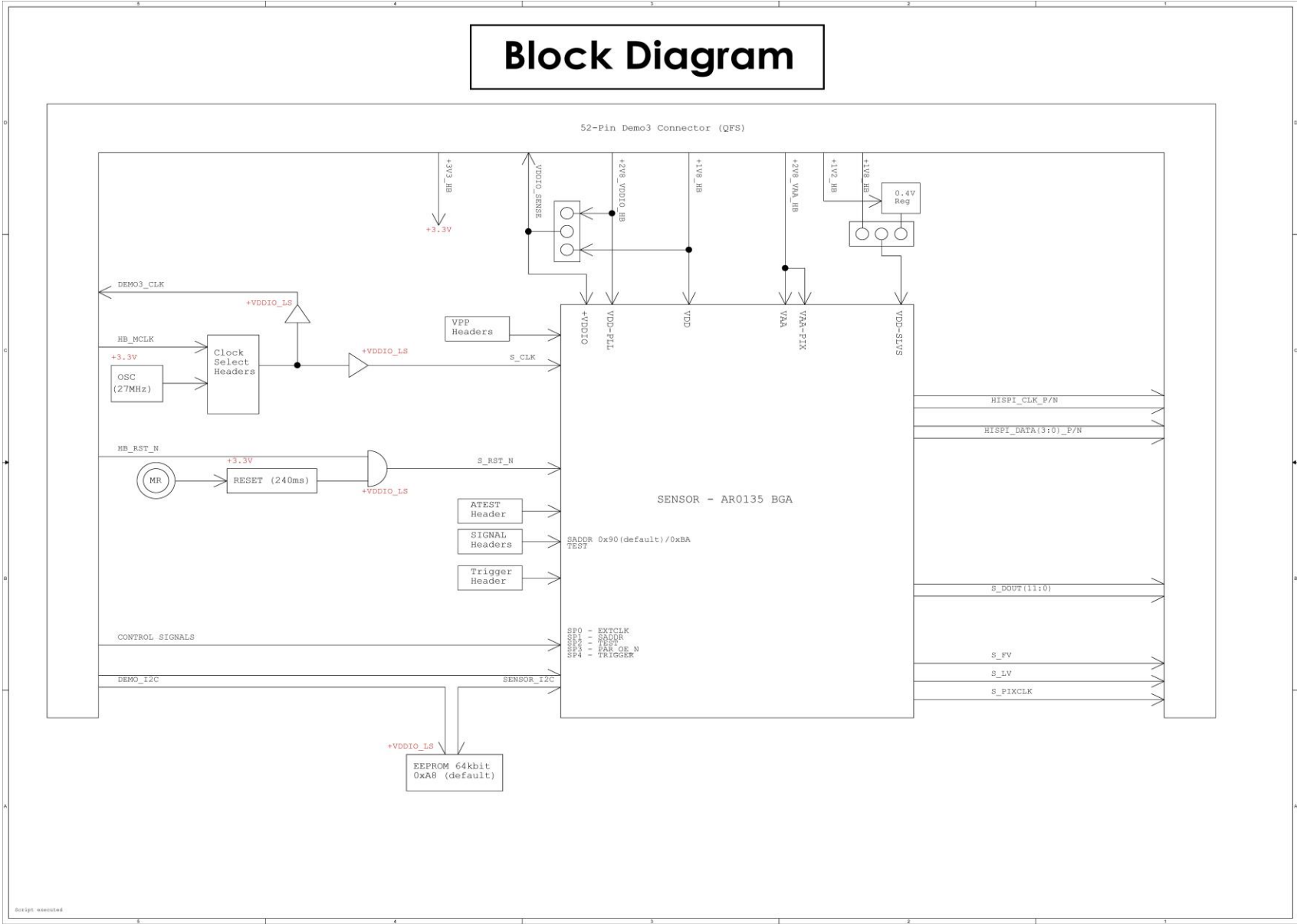



Sensor

+SVD	4	+SVD	4
+VIO	4.5	+VIO	4.5
+VDDIO_LS	4.5.6	+VDDIO_LS	4.5.6
VDD	4	VDD	4
VDD-ID	4	VDD-ID	4
VDD-SLVS	4	VDD-SLVS	4
VDD-PLL	4	VDD-PLL	4
VAA	4	VAA	4
VAA-PK	4	VAA-PK	4

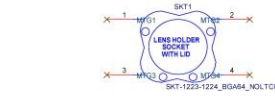
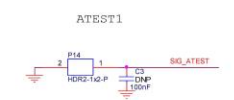
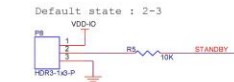
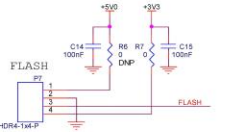
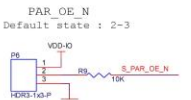
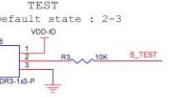
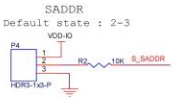
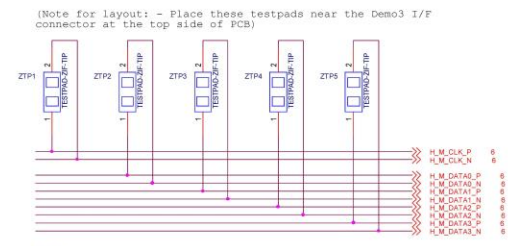
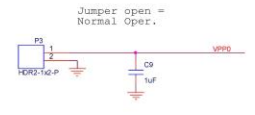
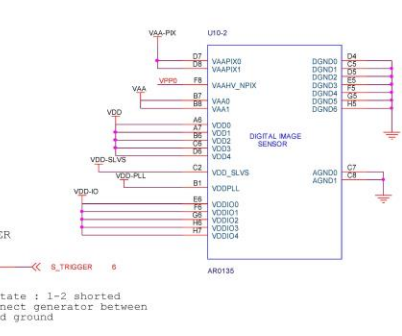
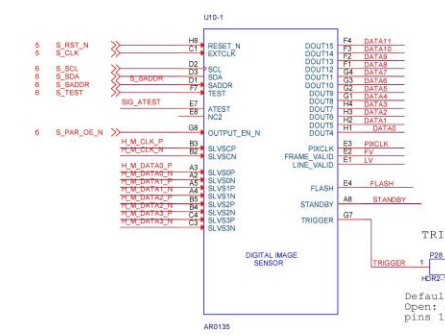

Debug Headers: Cut away the shorted trace and mount header for power debugging

Power

VDD 1.8V SUPPLY

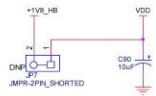

VDD-SLVS 1.8V SUPPLY

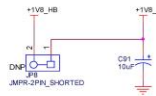

VDD-PLL 2.8V SUPPLY

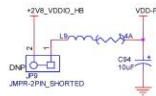

VAA 2.8V SUPPLY

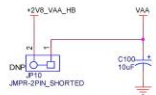

VAA-PIX 2.8V SUPPLY

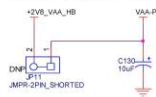

PERIPHERAL 5V SUPPLY

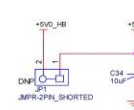

PERIPHERAL 3.3V SUPPLY

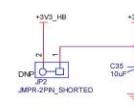

VDDIO & VDDIO LS 1.8V/2.8V SUPPLY

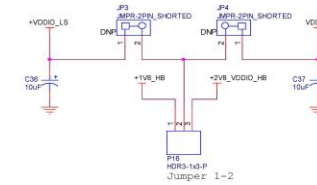

+5V0_HB	+5V0_HB	8
+3V3_HB	+3V3_HB	6
+2V8_VAA_HB	+2V8_VAA_HB	6
+2V8_VDDIO_HB	+2V8_VDDIO_HB	6
+1V8_HB	+1V8_HB	6
+1V2_HB	+1V2_HB	6
+5V0	+5V0	3
+3V3	+3V3	3,5
+VDDIO_LS	+VDDIO_LS	5,8
VDD	VDD	3
VDD-ID	VDD-ID	3
VDD-SLVS	VDD-SLVS	3
VDD-PLL	VDD-PLL	3
VAA	VAA	3
VAA-PIX	VAA-PIX	3

5V LED

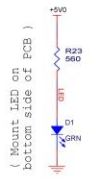

VDDSLVSPHY 0.4V SUPPLY

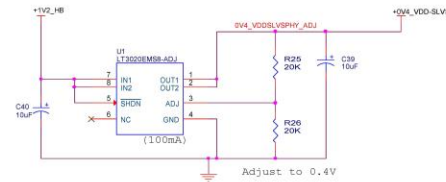

Selection of 0.4V or 1.2V/1V8 for VDDSLVSPHY supply

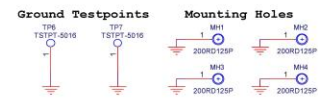
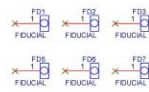
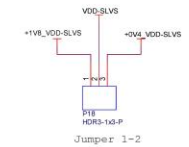



Clock and Reset

+5V0	+5V0	3,4
+3V3	+3V3	3,4
+VDD0_L5	+VDD0_L5	4,8

CLOCK CIRCUIT

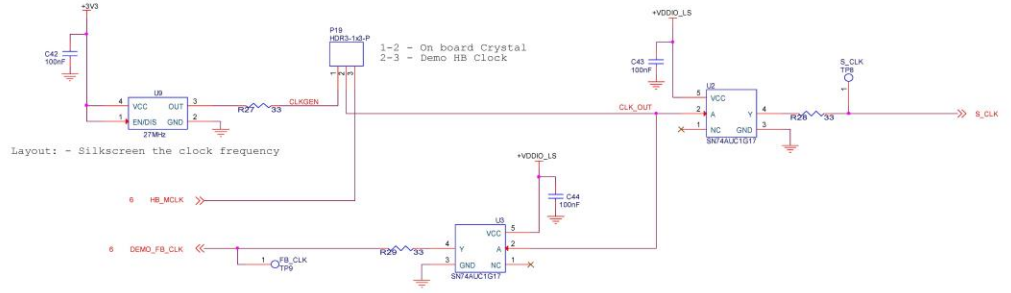

RESET CIRCUIT

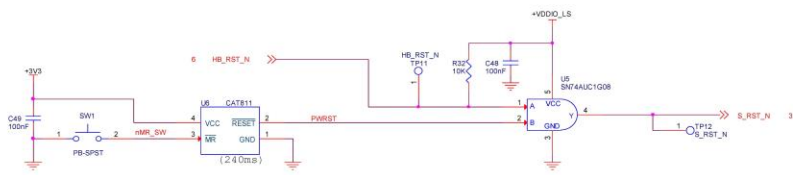

External Interface

+5V0_HB	4	+5V0_HB	4
+5V0_HB	4	+2V8_HB	4
+2V8_VAA_HB	4	+3V3_VAA_HB	4
+2V8_VDDIO_HB	4	+2V8_VDDIO_HB	4
+1V2_HB	4	+1V2_HB	4
+1V2_HB	4	+1V2_HB	4
+3V3_VDDIO_LS	3,4,5	+3V3_VDDIO_LS	3,4,5

DEMO3 BASEBOARD I/F

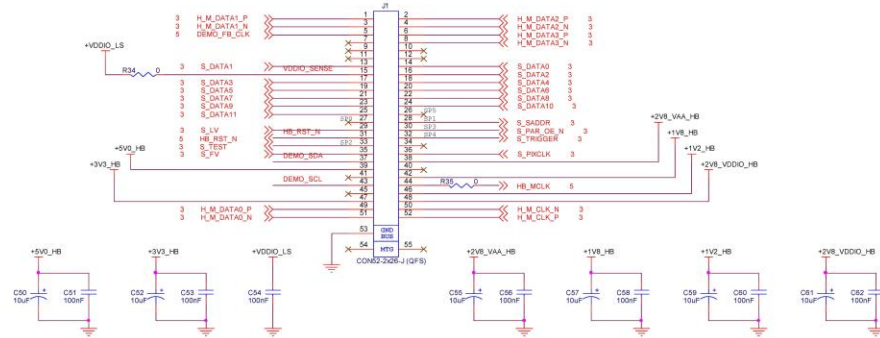

I2C DEBUG

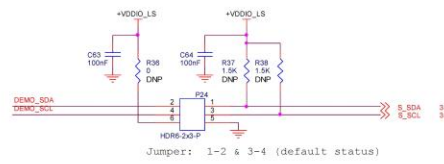

LENS CORRECTION EEPROM

