

# AR0237\_iBGA80\_Demo3Head

Page	Description
1	Title Page
2	Block Diagram
3	Sensor
4	Power
5	Clock and Reset
6	External Interfaces

Rev	Who	Date	Description
Rev 0.0	aralex	06/10/15	Initial schematic taken from AR0230 IBGA 80 demo3 HB design because the pinout is the same. Changed P3 from 2 pin header to 3 pin header Added R50, P30; Deleted R8
		06/12/15	Updated with the new Sensor part for AR0237



ON Semiconductor®

Title		
TITLE PAGE		
Size	Document Name	Rev
C	AR0237-BGA80_Demo3Head	0
Date: Friday, June 12, 2015 Sheet 1 of 6		

# Block Diagram

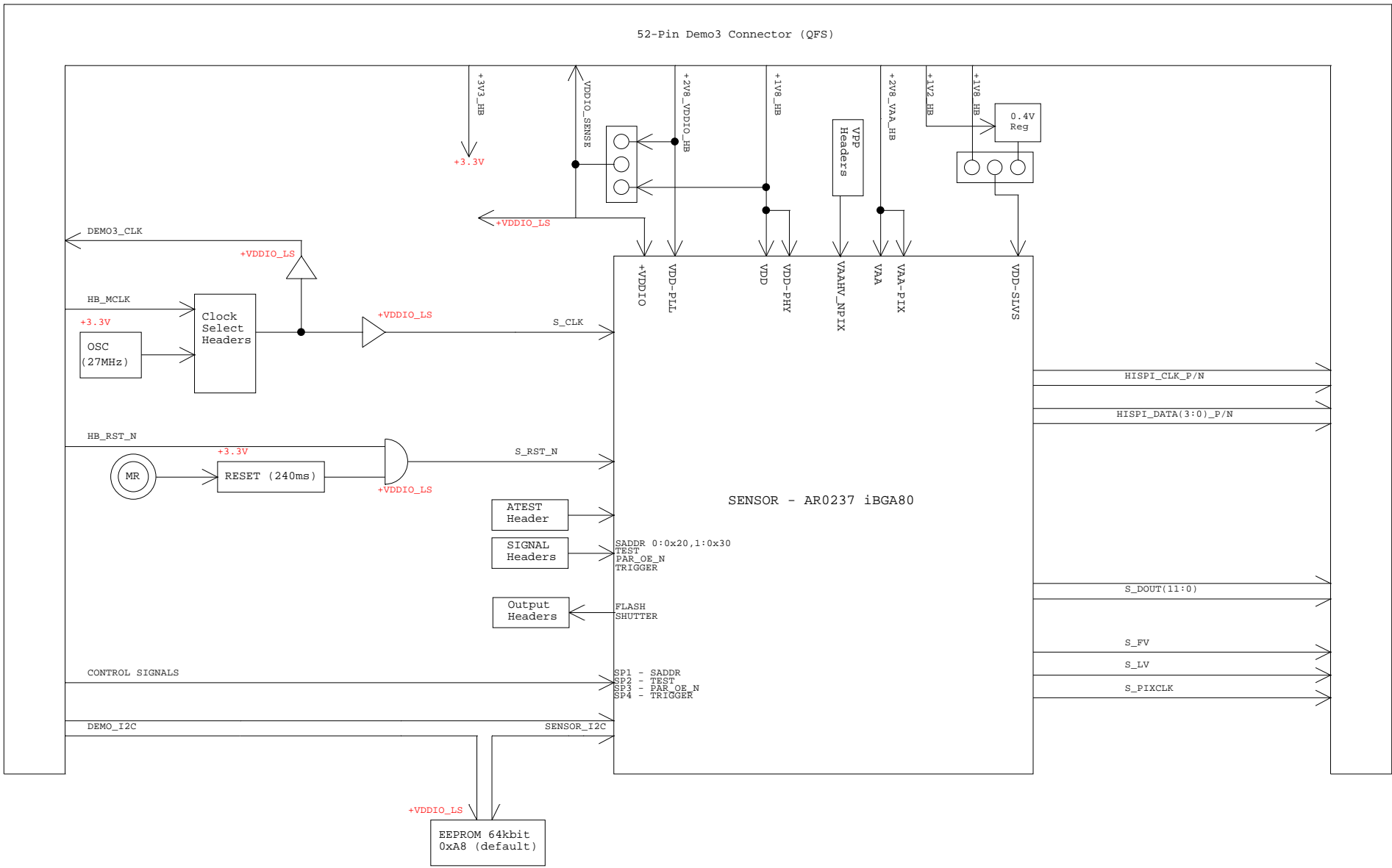

# Sensor

+5V0	4
+3V3	4,5
+VDDIO_LS	4,5,6
VDD	4
VDD-IO	4
VDD-PHY	4
VDD-SLVS	4
VDD-PLL	4
VAA	4
VAA-PIX	4

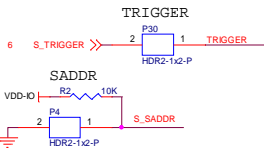
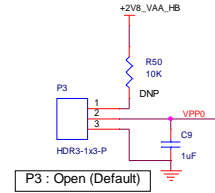
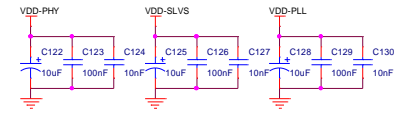
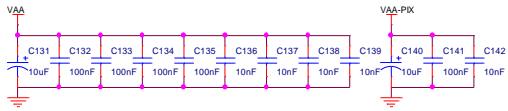
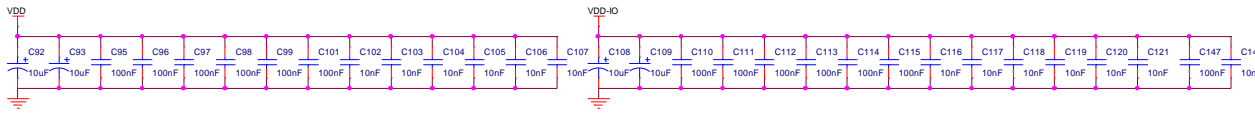

**Jumper P4:**  
 SHORT : SADDR= 0x20  
 OPEN : SADDR= 0x30

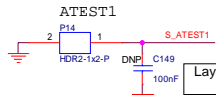
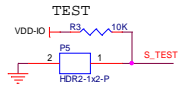

Layout Note: Place capacitor close to BGA ball of ATEST1 pin

**Default Jumper Settings**  
 P5 : SHORT (S\_TEST->GND)  
 P6 : SHORT (Parallel mode Default)  
 P14: SHORT (ATEST1->GND)

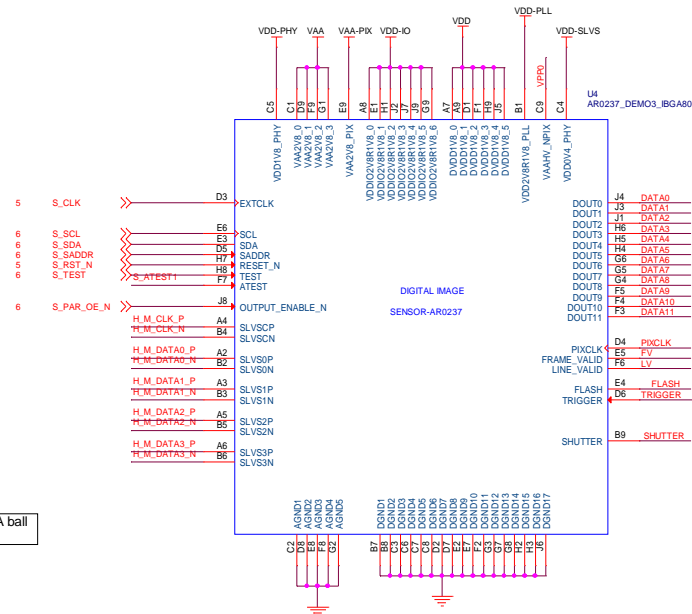
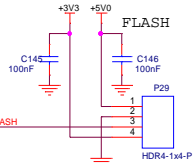

(Note for layout: - Place these testpads near the Demo3 I/F connector at the top side of PCB)

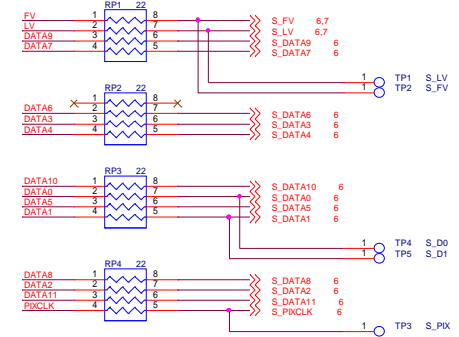
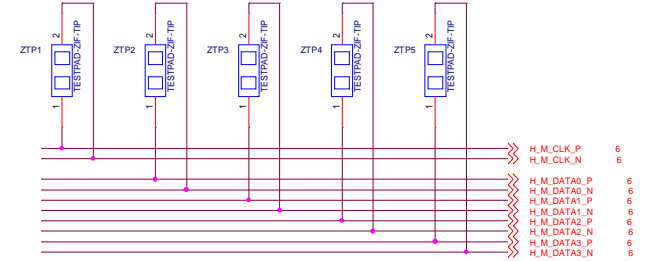

## TRIPOD MOUNT

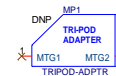

ON Semiconductor®

File		SENSOR	
Size	Document Name	Rev	0
C	AR0237-BGA80_Demo3Head		
Date:	Friday, June 12, 2015	Sheet	3 of 6

Debug Headers: Cut away the shorted trace and mount header for power debugging

# Power

## VDD 1.8V SUPPLY

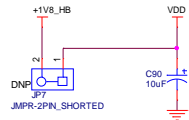

## VDD-PHY 1.8V SUPPLY

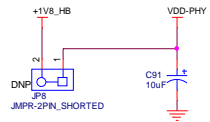

## VDD-SLVS 1.8V SUPPLY

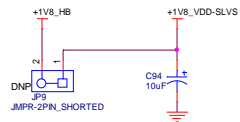

## VDD-PLL 2.8V SUPPLY

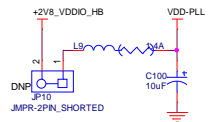

## VAA 2.8V SUPPLY

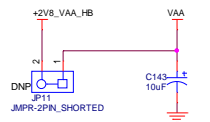

## VAA-PIX 2.8V SUPPLY

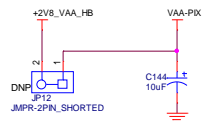

## PERIPHERAL 5V SUPPLY

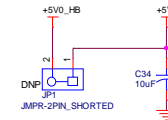

## PERIPHERAL 3.3V SUPPLY

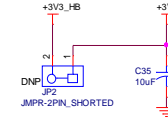

## VDDIO & VDDIO\_LS 1.8V/2.8V SUPPLY

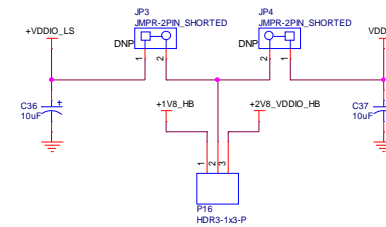

P16 Default Setting: 1-2 Short (1V8 operation)

## VDD\_SLVS 0.4V SUPPLY

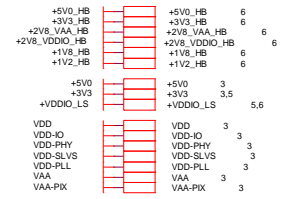
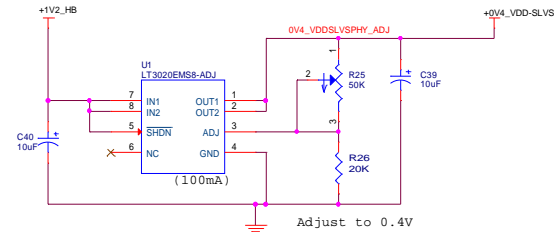

## 5V LED

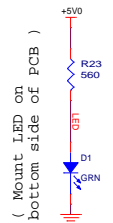

P18 Default Setting: 1-2 Short (SLVS mode)

### Fiducials



### Ground Testpoints



### Mounting Holes

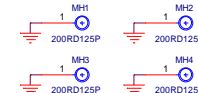



ON Semiconductor®

<b>POWER</b>	
File	Document Name
AR0237-BGA80_Demo3Head	Rev 0
Date: Friday, June 12, 2015	Sheet 4 of 6

# Clock and Reset

## CLOCK CIRCUIT

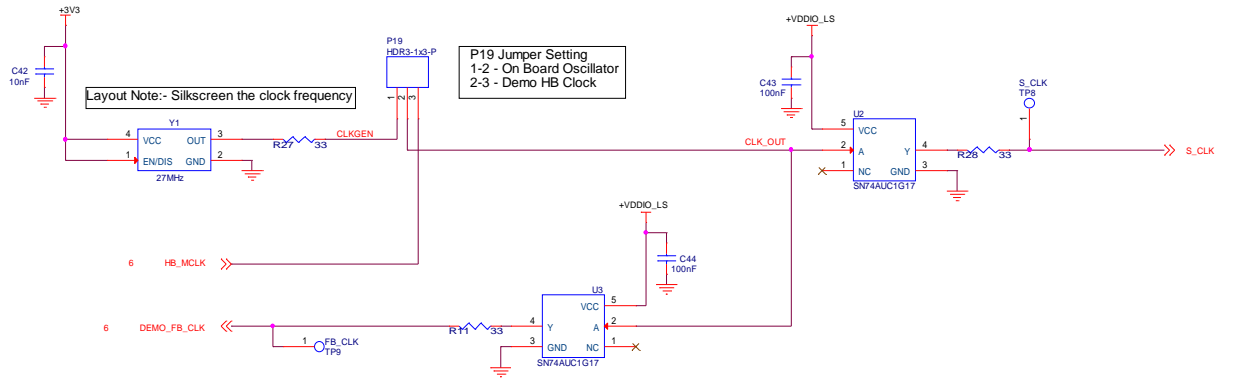

## RESET CIRCUIT

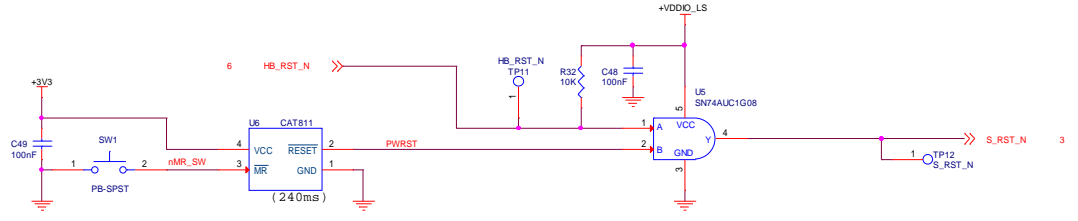

ON Semiconductor®		
Title <b>CLOCK AND RESET</b>		
Size C	Document Name AR0237-BGA80_Demo3Head	Rev 0
Date: Friday, June 12, 2015	Sheet 5	of 6

# External Interface

+5V0_HB	4	+5V0_HB	4
+3V3_HB	4	+3V3_HB	4
+2V8_VAA_HB	4	+2V8_VAA_HB	4
+2V8_VDDIO_HB	4	+2V8_VDDIO_HB	4
+1V8_HB	4	+1V8_HB	4
+1V2_HB	4	+1V2_HB	4
+3V3	3,4,5	+3V3	3,4,5
+VDDIO_LS	4,5	+VDDIO_LS	4,5

## DEMO3 BASEBOARD I/F

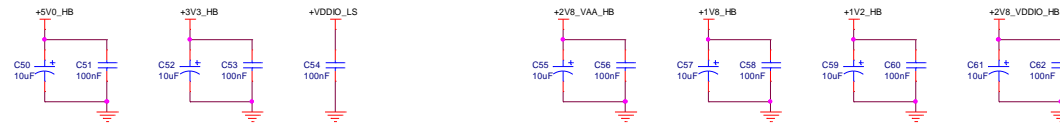
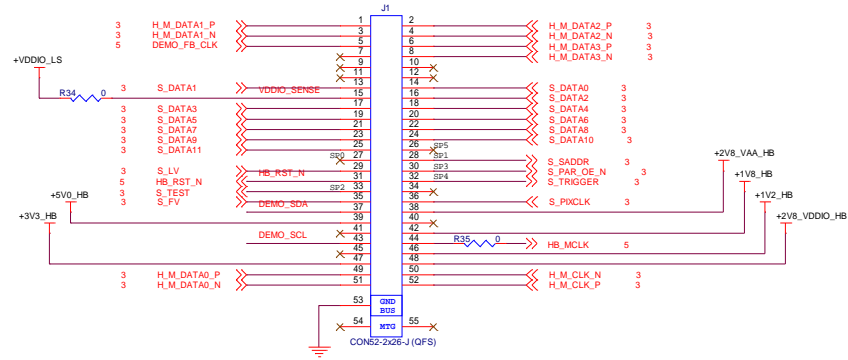

## I2C DEBUG

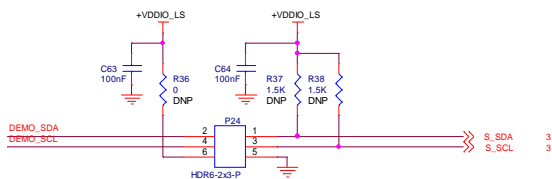

P24 Default Setting:  
 1-2 : Short : Demo and Sensor SDA connected  
 3-4 : Short : Demo and Sensor SCL connected

## LENS CORRECTION EEPROM

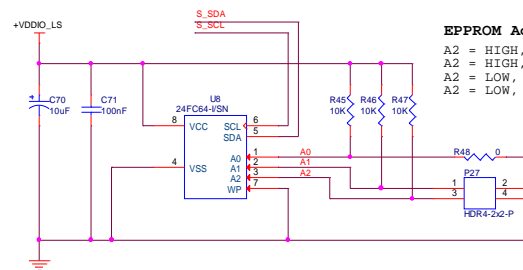

### EEPROM Address Switch Settings:

A2 = HIGH, A1 = LOW, A0 = LOW; Address => 0xA8 (default)  
 A2 = HIGH, A1 = HIGH, A0 = LOW; Address => 0xA9  
 A2 = LOW, A1 = HIGH, A0 = LOW; Address => 0xA4  
 A2 = LOW, A1 = LOW, A0 = LOW; Address => 0xA0

P27 Default Jumper Setting:  
 1-2 : Short => Ground/Low  
 3-4 : Open => Pull-up/High



ON Semiconductor®	
EXTERNAL INTERFACE	
Doc ID: 6500	Rev 0
Date: Friday, June 12, 2015	Sheet 6 of 6