



Is Now Part of



ON Semiconductor®

To learn more about ON Semiconductor, please visit our website at
www.onsemi.com

Please note: As part of the Fairchild Semiconductor integration, some of the Fairchild orderable part numbers will need to change in order to meet ON Semiconductor's system requirements. Since the ON Semiconductor product management systems do not have the ability to manage part nomenclature that utilizes an underscore (_), the underscore (_) in the Fairchild part numbers will be changed to a dash (-). This document may contain device numbers with an underscore (_). Please check the ON Semiconductor website to verify the updated device numbers. The most current and up-to-date ordering information can be found at www.onsemi.com. Please email any questions regarding the system integration to Fairchild_questions@onsemi.com.

ON Semiconductor and the ON Semiconductor logo are trademarks of Semiconductor Components Industries, LLC dba ON Semiconductor or its subsidiaries in the United States and/or other countries. ON Semiconductor owns the rights to a number of patents, trademarks, copyrights, trade secrets, and other intellectual property. A listing of ON Semiconductor's product/patent coverage may be accessed at www.onsemi.com/site/pdf/Patent-Marking.pdf. ON Semiconductor reserves the right to make changes without further notice to any products herein. ON Semiconductor makes no warranty, representation or guarantee regarding the suitability of its products for any particular purpose, nor does ON Semiconductor assume any liability arising out of the application or use of any product or circuit, and specifically disclaims any and all liability, including without limitation special, consequential or incidental damages. Buyer is responsible for its products and applications using ON Semiconductor products, including compliance with all laws, regulations and safety requirements or standards, regardless of any support or applications information provided by ON Semiconductor. "Typical" parameters which may be provided in ON Semiconductor data sheets and/or specifications can and do vary in different applications and actual performance may vary over time. All operating parameters, including "Typicals" must be validated for each customer application by customer's technical experts. ON Semiconductor does not convey any license under its patent rights nor the rights of others. ON Semiconductor products are not designed, intended, or authorized for use as a critical component in life support systems or any FDA Class 3 medical devices or medical devices with a same or similar classification in a foreign jurisdiction or any devices intended for implantation in the human body. Should Buyer purchase or use ON Semiconductor products for any such unintended or unauthorized application, Buyer shall indemnify and hold ON Semiconductor and its officers, employees, subsidiaries, affiliates, and distributors harmless against all claims, costs, damages, and expenses, and reasonable attorney fees arising out of, directly or indirectly, any claim of personal injury or death associated with such unintended or unauthorized use, even if such claim alleges that ON Semiconductor was negligent regarding the design or manufacture of the part. ON Semiconductor is an Equal Opportunity/Affirmative Action Employer. This literature is subject to all applicable copyright laws and is not for resale in any manner.

74LCX543

Low Voltage Octal Registered Transceiver with 5V Tolerant Inputs and Outputs

General Description

The LCX543 is a non-inverting octal transceiver containing two sets of D-type registers for temporary storage of data flowing in either direction. Separate Latch Enable and Output Enable inputs are provided for each register to permit independent input and output control in either direction of data flow.

The LCX543 is designed for low voltage (2.5V or 3.3V) V_{CC} applications with capability of interfacing to a 5V signal environment.

The LCX543 is fabricated with an advanced CMOS technology to achieve high speed operation while maintaining CMOS low power dissipation.

Features

- 5V tolerant inputs and outputs
- 2.3V – 3.6V V_{CC} specifications provided
- 7.0 ns t_{PD} max ($V_{CC} = 3.3V$), 10 μA I_{CC} max
- Power down high impedance inputs and outputs
- Supports live insertion/withdrawal (Note 1)
- ± 24 mA Output Drive ($V_{CC} = 3.0V$)
- Implements patented noise/EMI reduction circuitry
- Latch-up performance exceeds 500 mA
- ESD performance:
 - Human body model > 2000V
 - Machine model > 200V

Note 1: To ensure the high-impedance state during power up or down, \overline{OE} should be tied to V_{CC} through a pull-up resistor; the minimum value or the resistor is determined by the current-sourcing capability of the driver.

Ordering Code:

Order Number	Package Number	Package Description
74LCX543WMM	M24B	24-Lead Small Outline Integrated Circuit (SOIC), JEDEC MS-013, 0.300 Wide
74LCX543MSA	MSA24	24-Lead Shrink Small Outline Package (SSOP), EIAJ TYPE II, 5.3mm Wide
74LCX543MTC	MTC24	24-Lead Thin Shrink Small Outline Package (TSSOP), JEDEC MO-153, 4.4mm Wide

Devices also available in Tape and Reel. Specify by appending the suffix letter "X" to the ordering code.

Connection Diagram

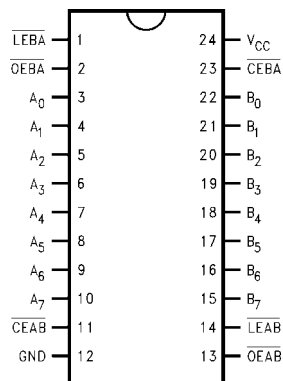

Pin Descriptions

Pin Names	Description
\overline{OEAB}	A-to-B Output Enable Input (Active LOW)
\overline{OEBA}	B-to-A Output Enable Input (Active LOW)
\overline{CEAB}	A-to-B Enable Input (Active LOW)
\overline{CEBA}	B-to-A Enable Input (Active LOW)
\overline{LEAB}	A-to-B Latch Enable Input (Active LOW)
\overline{LEBA}	B-to-A Latch Enable Input (Active LOW)
A_0 - A_7	A-to-B Data Inputs or B-to-A 3-STATE Outputs
B_0 - B_7	B-to-A Data Inputs or A-to-B 3-STATE Outputs

Logic Symbols

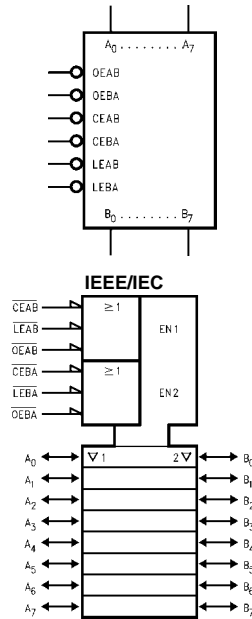

Data I/O Control Table

Inputs			Latch Status	Output Buffers
CEAB	LEAB	OEAB		
H	X	X	Latched	High Z
X	H	X	Latched	—
L	L	X	Transparent	—
X	X	H	—	High Z
L	X	L	—	Driving

H = HIGH Voltage Level
 L = LOW Voltage Level
 X = Immaterial
 A-to-B data flow shown; B-to-A flow control is the same, except using CEBA, LEBA and OEBA

Functional Description

The LCX543 contains two sets of eight D-type latches, with separate input and output controls for each set. For data flow from A to B, for example, the A-to-B Enable (\overline{CEAB}) input must be LOW in order to enter data from A_0 - A_7 or take data from B_0 - B_7 , as indicated in the Data I/O Control Table. With \overline{CEAB} LOW, a LOW signal on the A-to-B Latch Enable (\overline{LEAB}) input makes the A-to-B latches transparent; a subsequent LOW-to-HIGH transition of the \overline{LEAB} signal puts the A latches in the storage mode and their outputs no longer change with the A inputs. With \overline{CEAB} and \overline{OEAB} both LOW, the 3-STATE B output buffers are active and reflect the data present at the output of the A latches. Control of data flow from B to A is similar, but using the CEBA, LEBA and OEBA inputs.

Logic Diagram

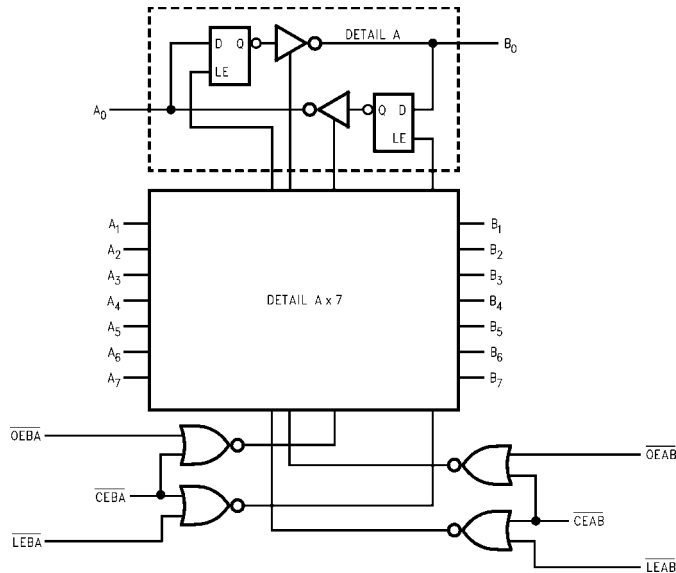

Please note that this diagram is provided only for the understanding of logic operations and should not be used to estimate propagation delays.

Absolute Maximum Ratings ^(Note 2)						
Symbol	Parameter	Value	Conditions	Units		
V _{CC}	Supply Voltage	-0.5 to +7.0		V		
V _I	DC Input Voltage	-0.5 to +7.0		V		
V _O	DC Output Voltage	-0.5 to +7.0 -0.5 to V _{CC} + 0.5	Output in 3-STATE Output in HIGH or LOW State (Note 3)	V		
I _{IK}	DC Input Diode Current	-50	V _I < GND	mA		
I _{OK}	DC Output Diode Current	-50 +50	V _O < GND V _O > V _{CC}	mA		
I _O	DC Output Source/Sink Current	±50		mA		
I _{CC}	DC Supply Current per Supply Pin	±100		mA		
I _{GND}	DC Ground Current per Ground Pin	±100		mA		
T _{STG}	Storage Temperature	-65 to +150		°C		
Recommended Operating Conditions (Note 4)						
Symbol	Parameter	Min	Max	Units		
V _{CC}	Supply Voltage	Operating	2.0	3.6	V	
		Data Retention	1.5	3.6		
V _I	Input Voltage	0	5.5	V		
V _O	Output Voltage	HIGH or LOW State	0	V _{CC}	V	
		3-STATE	0	5.5		
I _{OH} /I _{OL}	Output Current	V _{CC} = 3.0V – 3.6V		±24	mA	
		V _{CC} = 2.7V – 3.0V		±12		
		V _{CC} = 2.3V – 2.7V		±8		
T _A	Free-Air Operating Temperature	-40	85	°C		
Δt/ΔV	Input Edge Rate, V _{IN} = 0.8V – 2.0V, V _{CC} = 3.0V	0	10	ns/V		
<p>Note 2: The Absolute Maximum Ratings are those values beyond which the safety of the device cannot be guaranteed. The device should not be operated at these limits. The parametric values defined in the Electrical Characteristics tables are not guaranteed at the Absolute Maximum Ratings. The "Recommended Operating Conditions" table will define the conditions for actual device operation.</p> <p>Note 3: I_O Absolute Maximum Rating must be observed.</p> <p>Note 4: Unused inputs or I/O's must be held HIGH or LOW. They may not float.</p>						
DC Electrical Characteristics						
Symbol	Parameter	Conditions	V _{CC} (V)	T _A = -40°C to +85°C		Units
				Min	Max	
V _{IH}	HIGH Level Input Voltage		2.3 – 2.7	1.7		V
			2.7 – 3.6	2.0		
V _{IL}	LOW Level Input Voltage		2.3 – 2.7		0.7	V
			2.7 – 3.6		0.8	
V _{OH}	HIGH Level Output Voltage	I _{OH} = -100 μA	2.3 – 3.6	V _{CC} - 0.2		V
		I _{OH} = -8 mA	2.3	1.8		
		I _{OH} = -12 mA	2.7	2.2		
		I _{OH} = -18 mA	3.0	2.4		
		I _{OH} = -24 mA	3.0	2.2		
V _{OL}	LOW Level Output Voltage	I _{OL} = 100 μA	2.3 – 3.6		0.2	V
		I _{OL} = 8mA	2.3		0.6	
		I _{OL} = 12 mA	2.7		0.4	
		I _{OL} = 16 mA	3.0		0.4	
		I _{OL} = 24 mA	3.0		0.55	
I _I	Input Leakage Current	0 ≤ V _I ≤ 5.5V	2.3 – 3.6		±5.0	μA
I _{OZ}	3-STATE I/O Leakage	0 ≤ V _O ≤ 5.5V V _I = V _{IH} or V _{IL}	2.3 – 3.6		±5.0	μA
I _{OFF}	Power-Off Leakage Current	V _I or V _O = 5.5V	0		10	μA

DC Electrical Characteristics (Continued)									
Symbol	Parameter	Conditions	V _{CC} (V)	T _A = -40°C to +85°C		Units			
				Min	Max				
I _{CC}	Quiescent Supply Current	V _I = V _{CC} or GND	2.3 – 3.6		10	μA			
		3.6V ≤ V _I , V _O ≤ 5.5V (Note 5)	2.3 – 3.6		±10				
ΔI _{CC}	Increase in I _{CC} per Input	V _{IH} = V _{CC} - 0.6V	2.3 – 3.6		500	μA			
Note 5: Outputs disabled or 3-STATE only.									
AC Electrical Characteristics									
Symbol	Parameter	T _A = -40°C to +85°C, R _L = 500Ω						Units	
		V _{CC} = 3.3V ± 0.3V		V _{CC} = 2.7V		V _{CC} = 2.5V ± 0.2V			
		C _L = 50 pF		C _L = 50 pF		C _L = 30 pF			
		Min	Max	Min	Max	Min	Max		
t _{PHL}	Propagation Delay	1.5	7.0	1.5	8.0	1.5	8.4	ns	
t _{PLH}	A _n to B _n or B _n to A _n	1.5	7.0	1.5	8.0	1.5	8.4		
t _{PHL}	Propagation Delay	1.5	8.5	1.5	9.5	1.5	10.5	ns	
t _{PLH}	LEBA to A _n or LEAB to B _n	1.5	8.5	1.5	9.5	1.5	10.5		
t _{PZL}	Output Enable Time	1.5	9.0	1.5	10.0	1.5	11.0	ns	
t _{PZH}	OEBA or OEAB to A _n or B _n CEBA or CEAB to A _n or B _n	1.5	9.0	1.5	10.0	1.5	11.0		
t _{PLZ}	Output Disable Time	1.5	7.0	1.5	7.5	1.5	8.4	ns	
t _{PHZ}	OEBA or OEAB to A _n or B _n CEBA or CEAB to A _n or B _n	1.5	7.0	1.5	7.5	1.5	8.4		
t _S	Setup Time, HIGH or LOW Data to $\overline{\text{LEX}}\overline{\text{X}}$	2.5		2.5		4.0		ns	
t _H	Hold Time, HIGH or LOW Data to $\overline{\text{LEX}}\overline{\text{X}}$	1.5		1.5		2.0		ns	
t _W	Pulse Width, Latch Enable, LOW	3.3		3.3		3.3		ns	
t _{OSSL}	Output to Output Skew		1.0					ns	
t _{OSLH}	(Note 6)		1.0						
Note 6: Skew is defined as the absolute value of the difference between the actual propagation delay for any two separate outputs of the same device. The specification applies to any outputs switching in the same direction, either HIGH-to-LOW (t _{OSSL}) or LOW-to-HIGH (t _{OSLH}).									
Dynamic Switching Characteristics									
Symbol	Parameter	Conditions	V _{CC} (V)	T _A = 25°C		Units			
				Typical					
V _{OLP}	Quiet Output Dynamic Peak V _{OL}	C _L = 50 pF, V _{IH} = 3.3V, V _{IL} = 0V	3.3	0.8	V				
		C _L = 30 pF, V _{IH} = 2.5V, V _{IL} = 0V	2.5	0.6					
V _{OLV}	Quiet Output Dynamic Valley V _{OL}	C _L = 50 pF, V _{IH} = 3.3V, V _{IL} = 0V	3.3	-0.8	V				
		C _L = 30 pF, V _{IH} = 2.5V, V _{IL} = 0V	2.5	-0.6					
Capacitance									
Symbol	Parameter	Conditions	Typical	Units					
C _{IN}	Input Capacitance	V _{CC} = Open, V _I = 0V or V _{CC}	7	pF					
C _{I/O}	Input/Output Capacitance	V _{CC} = 3.3V, V _I = 0V or V _{CC}	8	pF					
C _{PD}	Power Dissipation Capacitance	V _{CC} = 3.3V, V _I = 0V or V _{CC} , f = 10 MHz	25	pF					

AC LOADING and WAVEFORMS Generic for LCX Family

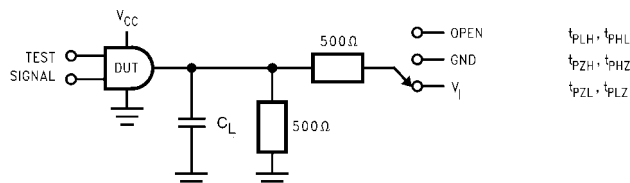
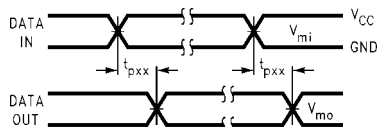
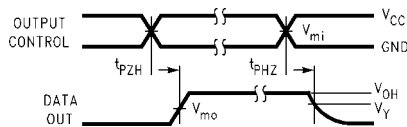

FIGURE 1. AC Test Circuit (C_L includes probe and jig capacitance)

Test	Switch
t_{PLH}, t_{PHL}	Open
t_{PZL}, t_{PLZ}	6V at $V_{CC} = 3.3 \pm 0.3V$ $V_{CC} \times 2$ at $V_{CC} = 2.5 \pm 0.2V$
t_{PZH}, t_{PHZ}	GND



Waveform for Inverting and Non-Inverting Functions



3-STATE Output High Enable and Disable Times for Logic

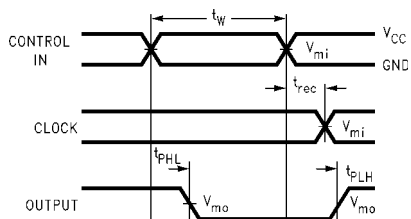

Propagation Delay, Pulse Width and t_{rec} Waveforms

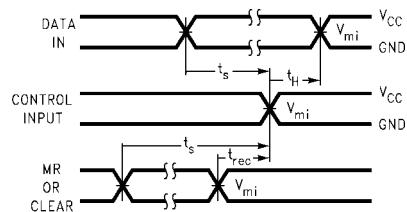

Setup Time, Hold Time and Recovery Time for Logic

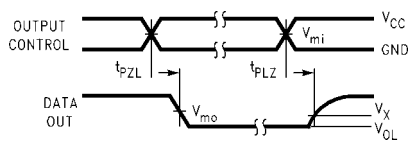

3-STATE Output Low Enable and Disable Times for Logic

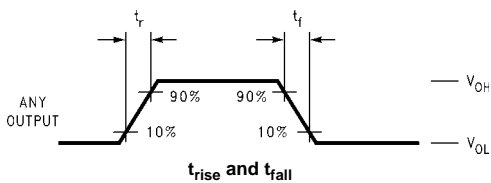
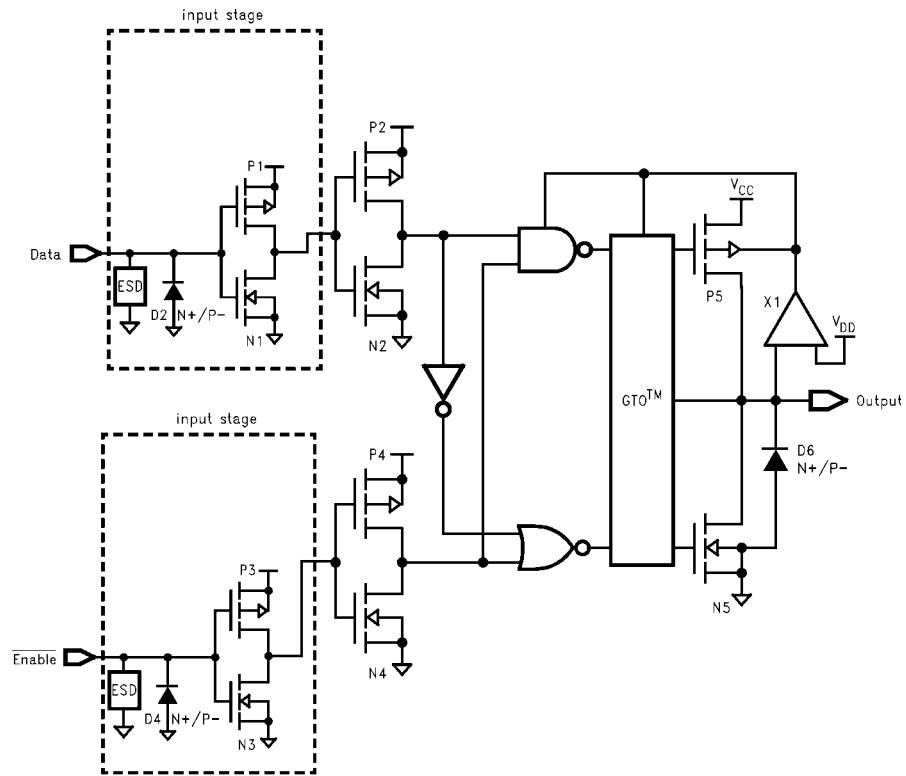

FIGURE 2. Waveforms
(Input Characteristics; $f = 1MHz$, $t_R = t_F = 3ns$)

Symbol	V_{CC}		
	$3.3V \pm 0.3V$	2.7V	$2.5V \pm 0.2V$
V_{mi}	1.5V	1.5V	$V_{CC}/2$
V_{mo}	1.5V	1.5V	$V_{CC}/2$
V_x	$V_{OL} + 0.3V$	$V_{OL} + 0.3V$	$V_{OL} + 0.15V$
V_y	$V_{OH} - 0.3V$	$V_{OH} - 0.3V$	$V_{OH} - 0.15V$

Schematic Diagram Generic for LCX Family



Physical Dimensions inches (millimeters) unless otherwise noted

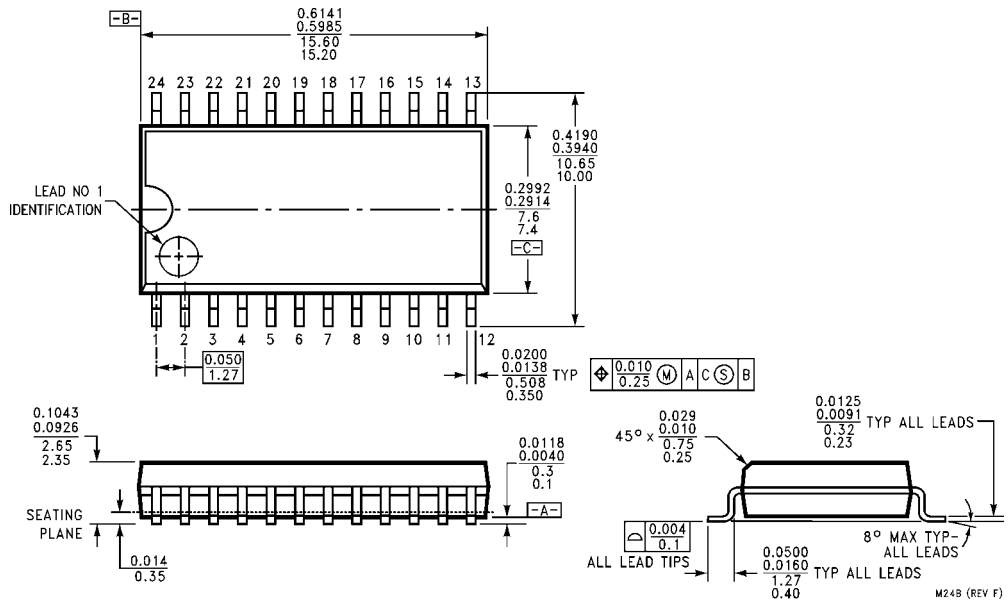

24-Lead Small Outline Integrated Circuit (SOIC), JEDEC MS-013, 0.300 Wide Package Number M24B

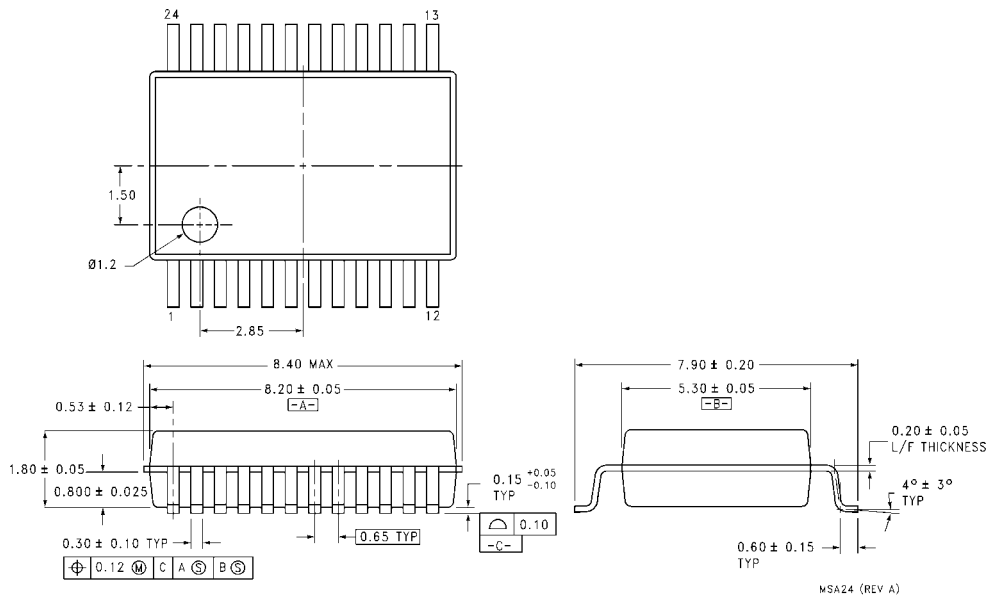

24-Lead Shrink Small Outline Package (SSOP), EIAJ TYPE II, 5.3mm Wide Package Number MSA24

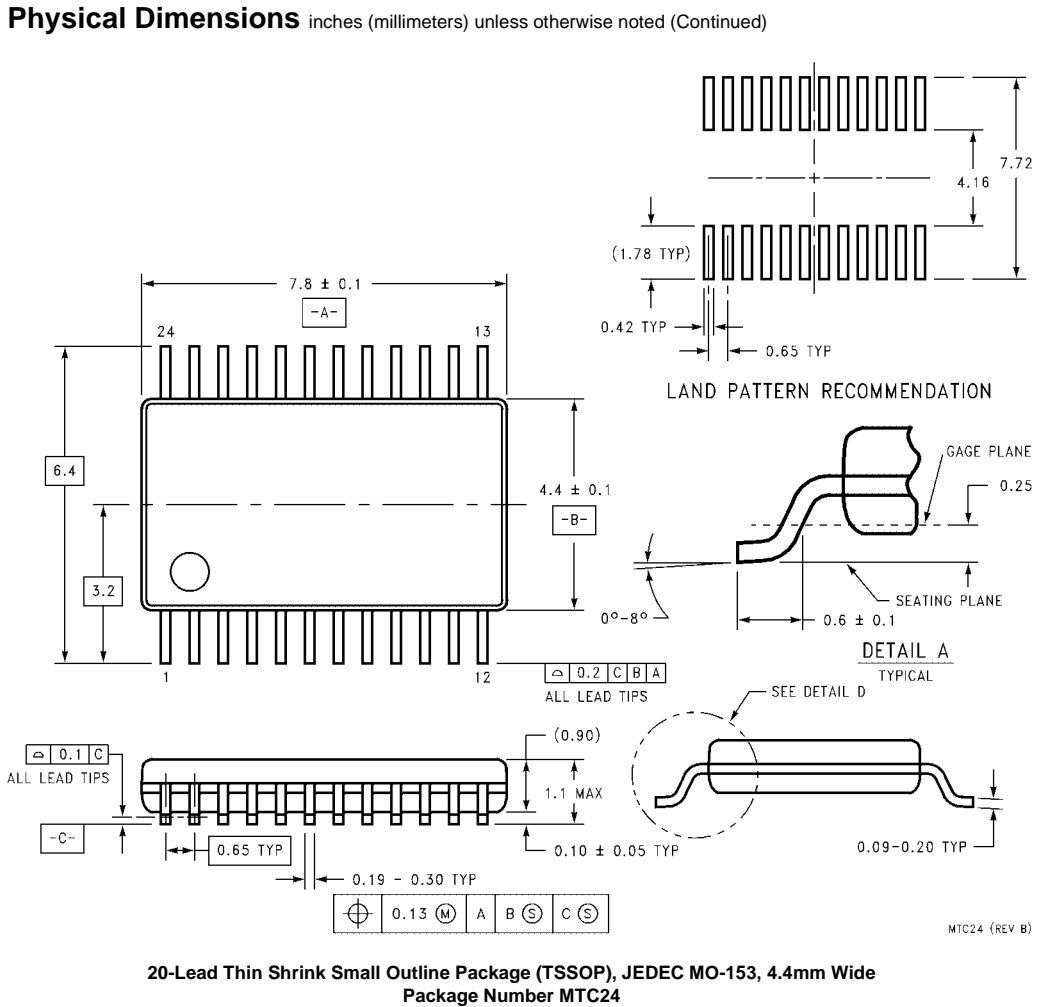

Fairchild does not assume any responsibility for use of any circuitry described, no circuit patent licenses are implied and Fairchild reserves the right at any time without notice to change said circuitry and specifications.

LIFE SUPPORT POLICY

FAIRCHILD'S PRODUCTS ARE NOT AUTHORIZED FOR USE AS CRITICAL COMPONENTS IN LIFE SUPPORT DEVICES OR SYSTEMS WITHOUT THE EXPRESS WRITTEN APPROVAL OF THE PRESIDENT OF FAIRCHILD SEMICONDUCTOR CORPORATION. As used herein:

1. Life support devices or systems are devices or systems which, (a) are intended for surgical implant into the body, or (b) support or sustain life, and (c) whose failure to perform when properly used in accordance with instructions for use provided in the labeling, can be reasonably expected to result in a significant injury to the user.
2. A critical component in any component of a life support device or system whose failure to perform can be reasonably expected to cause the failure of the life support device or system, or to affect its safety or effectiveness.

www.fairchildsemi.com

ON Semiconductor and  are trademarks of Semiconductor Components Industries, LLC dba ON Semiconductor or its subsidiaries in the United States and/or other countries. ON Semiconductor owns the rights to a number of patents, trademarks, copyrights, trade secrets, and other intellectual property. A listing of ON Semiconductor's product/patent coverage may be accessed at www.onsemi.com/site/pdf/Patent-Marking.pdf. ON Semiconductor reserves the right to make changes without further notice to any products herein. ON Semiconductor makes no warranty, representation or guarantee regarding the suitability of its products for any particular purpose, nor does ON Semiconductor assume any liability arising out of the application or use of any product or circuit, and specifically disclaims any and all liability, including without limitation special, consequential or incidental damages. Buyer is responsible for its products and applications using ON Semiconductor products, including compliance with all laws, regulations and safety requirements or standards, regardless of any support or applications information provided by ON Semiconductor. "Typical" parameters which may be provided in ON Semiconductor data sheets and/or specifications can and do vary in different applications and actual performance may vary over time. All operating parameters, including "Typicals" must be validated for each customer application by customer's technical experts. ON Semiconductor does not convey any license under its patent rights nor the rights of others. ON Semiconductor products are not designed, intended, or authorized for use as a critical component in life support systems or any FDA Class 3 medical devices or medical devices with a same or similar classification in a foreign jurisdiction or any devices intended for implantation in the human body. Should Buyer purchase or use ON Semiconductor products for any such unintended or unauthorized application, Buyer shall indemnify and hold ON Semiconductor and its officers, employees, subsidiaries, affiliates, and distributors harmless against all claims, costs, damages, and expenses, and reasonable attorney fees arising out of, directly or indirectly, any claim of personal injury or death associated with such unintended or unauthorized use, even if such claim alleges that ON Semiconductor was negligent regarding the design or manufacture of the part. ON Semiconductor is an Equal Opportunity/Affirmative Action Employer. This literature is subject to all applicable copyright laws and is not for resale in any manner.

PUBLICATION ORDERING INFORMATION

LITERATURE FULFILLMENT:

Literature Distribution Center for ON Semiconductor
19521 E. 32nd Pkwy, Aurora, Colorado 80011 USA
Phone: 303-675-2175 or 800-344-3860 Toll Free USA/Canada
Fax: 303-675-2176 or 800-344-3867 Toll Free USA/Canada
Email: orderlit@onsemi.com

N. American Technical Support: 800-282-9855 Toll Free
USA/Canada
Europe, Middle East and Africa Technical Support:
Phone: 421 33 790 2910
Japan Customer Focus Center
Phone: 81-3-5817-1050

ON Semiconductor Website: www.onsemi.com
Order Literature: <http://www.onsemi.com/orderlit>
For additional information, please contact your local
Sales Representative